



Future Health Concepts

- Sterilizers
- Anesthesia Machines
- Patient Monitors
- Surgical Scrub Sinks
- Defibrillators
- Imaging Tables
- Diagnostic Equipment
- Blanket & Fluid Warming Cabinets
- Stretchers



Vascular Catalog

Visit www.fhcusa.com or call us toll free at 800.282.8644



Table of Contents

Since 1975 Future Health Concepts has concentrated on manufacturing the highest quality healthcare equipment available. Utilizing state of the art equipment, such as 3-D CAD solid modeling, fully automated punch press line, and highly-skilled craftsmen, we make it possible to produce equipment unparalleled in the marketplace.

FHC carries all the necessary equipment to supply your facility from blanket and fluid warmers, imaging tables, and patient monitors, all the way down to stethoscopes and surgical instruments to ensure we meet all of our customer's expectations. Since 1975, we have built our business mostly through equipment planners & referrals and are now contracted supplier's with some of the largest GPO's; Novation, MedAssets, Amerinet, Premier, and Quorum.



Table of Contents 	Blanket Warmers  A1	Imaging Tables  B1	Surgical Lights  C1	Transport Stretchers  D1
Tabletop Sterilizers  E1	Surgical Scrub Sinks  F1	Anesthesia Machines  G1	Anesthesia Machine Parts  H1	Patient Monitors  I1
Monitor Accessories  J1	Defibrillators  K1	Medical Carts  L1	Medical Cart Accessories  M1	Stainless Steel Tables  N1

Table of Contents

Mayo Stands  O1	Solution Stands  P1	IV Stands  Q1	Linen Hampers  R1	Footstools  S1
Kick Buckets  T1	Exam Tables  U1	Clinical Recliners  V1	Overbed Tables  W1	Medical Seating  X1
Storage & Organization  Y1	Scales  Z1	Patient Handling  AA1	Diagnostic Equipment  AB1	Wheelchairs  AC1
Surgical Instruments  AD1	Radiation Accessories  AE1	Replacement Parts  AF1		

Blanket & Fluid Warmers

We offer a large variety of features and options for your convenience!

Future Health Concepts, Inc. offers a variety of Blanket and Fluid Warming Cabinets in both standard and custom sizes to meet individual requirements. As with all of our products, warming cabinets undergo stringent testing procedures during the manufacturing process to assure a long life, the highest quality, and accurate temperature settings. We offer standard sizes along with custom sizes to meet specific requirements.

Standard Features:

- Stainless steel or glass door
- Data logging of real time & temp w/ USB retrieval
- Keyed temperature lock out
- Push button digital operation
- Large dual digital displays
- Displays actual temperature and set point at all times
- Separate digitally controlled heating chambers
- Rapid warm time (2-6 hours depending on load)
- Uniform heating
- Fully insulated
- Audible & visual over-temp alarm
- UL/CUL approved
- FDA registered
- OSHPD pre-approved

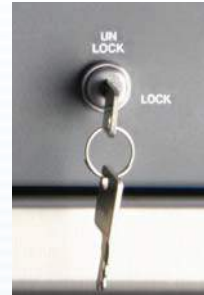

Standard keyed temperature lockout



Optional door lock

Options:

- Mobile base or cart
- 18" depth
- Full recess
- Pass through chamber
- Left hand door hinge
- Keyed door lock
- Seismic brackets
- 220/240 V, 50/60HZ
- Custom sizes
- Solution baskets
- Touch-screen



FHCSWC1824-B-G

(Shown w/ optional s/s solution baskets)

Blanket & Fluid Warmers

All blanket warmers can be customized to fit your specifications!



FHCSWC24-G

FHCSWC24

Overall Size: 30" W x 26.5" D x 24.5" H

Chamber I.D.

26" W x 23" D x 15.25" H
5.27 cubic feet of storage
Temperature range: 90-160°F
Accuracy +/- 1°F of set point
1 adjustable shelf

Electrical

120v, 7.5 amp., 50/60HZ
.30 kw/hr, 1024 btu/hr
UL/CUL listed
FDA registered



FHCSWC36-G

FHCSWC36

Overall Size: 30" W x 26.5" D x 36" H

Chamber I.D.

26" W x 23" D x 25" H
8.63 cubic feet of storage
Temperature range: 90-160°F
Accuracy +/- 1°F of set point
2 adjustable shelves

Electrical

120v, 7.5 amp., 50/60HZ
.30 kw/hr, 1024 btu/hr
UL/CUL listed
FDA registered

FHC Optional Mobile Stands

FHCT0007: 26"W x 34"D x 34"H

Recommended for models FHCSWC24 & FHCSWC36

FHCT0023: 26"W x 20"D x 34"H

Recommended for models FHCSWC1518 & FHCSWC1824

(If ordered w/ warmer add -MS to model #)



FHCT0007

FHCT0023

BLANKET & FLUID WARMERS

Blanket & Fluid Warmers



(Shown w/ optional mobile base)

FHCSWC2460

Overall Size:

24" W x 20.5" D x 64.75" H
3 adjustable shelves

Chamber I.D.

20" W x 17" D x 49.5" H
13.05 cubic feet of storage
Temperature range: 90-160°F
Accuracy +/- 3°F of set point

Electrical

120v, 7.5 amp., 50/60HZ
.49 kw/hr, 1678 btu/hr
UL/CUL listed
FDA registered



(Shown w/ optional mobile base)

FHCDWC24

Overall Size:

30" W x 26.5" D x 74.5" H
17.2 cubic feet of storage
3 adjustable shelves

Upper Chamber I.D.

26" W x 23" D x 15.25" H
5.27 cubic feet of storage
Temperature range: 90-160°F
Accuracy +/- 1°F of set point

Lower Chamber I.D.

26" W x 23" D x 34.5" H
11.93 cubic feet of storage
Temperature range: 90-160°F
Accuracy +/- 3°F of set point

Electrical

120v, 12 amp., 50/60HZ
.75 kw/hr, 2557 btu/hr
UL/CUL listed
FDA registered

Blanket & Fluid Warmers

Blanket & Fluid Warmer Storage Information:

Model #	Total Cubic Feet	# of Blankets*	# of Solution 1 Liter Bottles	# of 1/2 Liter Bottles
FHCSWC1518	1.40	1-2	9	-
FHCSWC1824	3.00	6-9	20	-
FHCSWC24	5.27	9-14	36	-
FHCSWC2460	9.73	30-40	66	-
FHCSWC36	8.63	24-30	72	-
FHCSWC60	13.05	50-65	89	-
FHCSWC72	21.00	65-85	143	-
FHCDWC24 Lower Chamber	11.93	35-50	-	-
FHCDWC2424 Lower Chamber	11.93	35-50	-	-
FHCDWC2460 Lower Chamber	4.80	14-22	-	-
FHCDWC36 Lower Chamber	8.96	24-30	-	-
FHCDWC60 Lower Chamber	6.27	12-16	-	-
FHCTWC24 Lower Chamber	6.4	12-16	-	-
30" Roll-out Basket	-	-	30	42
1824 Roll-out Basket	-	-	16	20

***Number of blankets will depend on thickness of blankets, positioning, and fold.**

Warranty

All warming cabinets manufactured by Future Health Concepts, Inc. (FHC) will carry a lifetime guarantee against product craftsmanship, **1-year labor and 5-year parts guarantee**. The factory will service all units without cost to the buyer for 1-year from shipment. After the 1-year period, replacement of a defective part (labor) will be at buyer's expense. We will exchange all defective parts at no cost to the buyer for a period of 5-years from shipment. All defective parts must be returned within 30 days to ensure proper credit. An RA from Future Health Concepts, Inc. must be obtained prior to items return.

Imaging Tables



BI058-840

Biodex C-Arm 840 Surgical Table:

- Low attenuation carbon fiber tabletop, w/ choice of standard contoured or rectangular design
- Contoured tabletop features face cutout for comfortable prone positioning
- High-speed actuators assure quick, 3 axis, motorized, tabletop positioning
- Includes hand & foot-operated controllers
- Free-float X-Y tabletop
- 500-lb patient capacity
- Low profile base for C-Arm clearance
- Accessory rails
- Both AC & battery power are standard

The Biodex Surgical C-Arm Table 840 is designed for image-guided procedures where stability, access, and precise, quiet, vibration-free positioning are essential. A cantilevered low attenuation carbon fiber tabletop, w/ choice of contoured or rectangular design, accommodates portable or ceiling-suspended C-Arms. The extra-large radiolucent area, free-float X-Y tabletop, motorized control of height, lateral roll, Trendelenburg motions and catheter tray extension make the Biodex 840 Surgical C-Arm Table ideal for cardiovascular procedures.

The Biodex 846 Surgical C-Arm Table is designed for procedures where stability, access and precise, quiet, vibration-free positioning are essential. A cantilevered low attenuation carbon fiber tabletop, w/ choice of contoured or rectangular design, accommodates portable or ceiling-suspended C-Arms. The standard contoured top of the Biodex 846 surgical table, allows ample workspace for anesthesiologists, yet the narrowness required for cervical procedures. The rectangular top offers additional space to allow for superior image quality for long-leg runoff studies and is an ideal surgical table for both pain care and cardiovascular applications.



BI058-846

Biodex C-Arm 846 Surgical Table:

- Low attenuation carbon fiber tabletop, w/ choice of standard contoured or rectangular design
- Contoured tabletop features face cutout for comfortable prone positioning
- High-speed actuators assure quick, 3 axis, motorized, tabletop positioning
- Includes hand & foot-operated controllers
- Free-float X-Y tabletop
- 500-lb patient capacity
- Low profile base for C-Arm clearance
- Accessory rails

Imaging Tables



BI058-870

Biodex Pain Management C-Arm 870 Surgical Table:

- Measures 93"L x 26" with OR accessory rails
- Table top measures: 90"L x 24" W
- 2" thick mattress
- Height adjustable from 30" to 40"
- Trendelenburg 0° to 20°
- Reverse trendelenburg 0° to 20°
- Lateral roll 0° to 20°
- Hand control actuates all modes
- Locking 5" swivel casters
- 500 lb. weight capacity
- 115 VAC or 230 VAC
- Low profile base for C-arm clearance

The Biodex Pain Management C-Arm 870 operating table is carefully constructed to provide enhanced stability, access, and precise, quiet, vibration-free positioning during usage. With a low attenuation carbon fiber tabletop and high-speed actuators for quick, three axis motorized tabletop positioning, the Pain Management C-arm surgical table ensures each operator gets flexible and easy pain care management. A 2 inch thick mattress and 500 pound weight capacity provides comfort for even the heaviest patients. The choice of standard contoured or rectangular design allows customers to select the tabletop that best fits the need to achieve maximum image resolution.

Also available: Biodex Pain Management C-Arm 878 Surgical Table:

- Same as 870 surgical table, but with 30" top and battery



FHC-SUSL

Carbon Fiber X-Ray Imaging Table:

- Diving board style for easy c-arm access
- Large patient capacity- 500 pound load
- 2" high quality patient comfort pad
- Facial Cut-out for prone procedures
- Lightweight - easy to physically move the table
- 24" top eliminates need for arm boards
- Simple to use, top quality wheel locks
- Easy patient transfer to table

FHC Streamline SUSL-1 Imaging Table:

Low-high 28" to 38" 120v

FHC Streamline SUSL-2 Imaging Table:

Low-high 28" to 38", and lateral tilt (+-) 17°, 120v,

FHC Streamline SUSL-3 Imaging Table:

Low-high 28" to 38", lateral tilt (+-) 17°, and trendelenburg (+-) 20°, 120v

***Three Year Parts & Labor Warranty**

FHC Streamline SUSL-4 Imaging Table:

Low-high 28" to 38", lateral tilt (+-) 17°, and trendelenburg (+-) 20°, and longitudinal slide of 10" head to foot (plus or minus 5"), 120v

FHC Streamline SUSL-5 Imaging Table:

Low-high 28" to 38", lateral tilt (+-) 17°, and trendelenburg (+-) 20°, longitudinal slide of 10" head to foot (plus or minus 5"), and lateral side to side 10" (plus or minus 5"), 120v

Surgical Lights

FHC AIM-LED Examination Light

- **Illuminance:** 45,000 lux at 1 meter
- **Color Temperature:** 4500°K
- **Diameter of Lighthouse:** 18"
- **Light Field Diameter:** 6.5 - 12"
- **Focusing:** Twist handle
- **CRI (Color Rendering Index):** 95
- **Rotation:** 360° (limitless) on single ceiling models
- **Sterilizable Handle:** Removable
- **Number of Bulbs:** 3 LED modules
- **Light Source:** LED
- **Rated life of LED Lamp:** 50,000 hours
- **Mounting Options:** ceiling, wall, or roll stand
- **Warranty:** 5 year limited warranty



The new AIM-LED combines the smart and versatile design of the AIM light, with the efficiency and longevity of an LED light. This LED surgery light provides 10% more illumination than the already high performing AIM-50 and 10 times more life than halogen light sources, with half the power. The 92 CRI rating of the surgery light creates accurate color visibility for a completely accurate diagnosis.

FHC Mira LED Surgical Light

- **Illuminance:** available in 50,000, 65,000, and 90,000 lux
- **Color Temperature:** 4500°K
- **Diameter of Lighthouse:** 18"
- **Light Field Diameter:** 6.5 - 12"
- **Focusing:** Twist handle
- **CRI (Color Rendering Index):** 95
- **Rotation:** 360° (limitless) on single ceiling models
- **Sterilizable Handle:** Removable
- **Number of Bulbs:** 36
- **Light Source:** LED
- **Rated life of LED Lamp:** 50,000 hours
- **Mounting Options:** ceiling, wall, or roll stand
- **Warranty:** 5 year limited warranty



As the latest advancement in minor surgery and diagnostic lighting technology, the Mira Series LED Surgical Light's precisely positioned LED's ensure superior shadow control, depth of field, and light intensity. A slim design and control pad on the lighthouse provide reduced workspace clutter and easy access to light functions. With a CRI of 95 and color temperature of 4500K, the Mira LED Medical Light creates outstanding color accuracy for minor surgeries and examinations.

Surgical Lights

FHC CoolSpot II Examination Light

- **Illuminance:** 60,000 lux at 1 meter
- **Color Temperature:** 4300°K
- **Light Field Diameter:** 2 - 10"
- **Focusing:** Adjustable by rotating center handle
- **CRI (Color Rendering Index):** 94
- **Rotation:** extension pivots 320° on ceiling
- **Sterilizable Handle:** Removable
- **Number of Bulbs:** 1
- **Light Source:** Halogen, 150 W
- **Rated life of Halogen Lamp:** 600 hours
- **Mounting Options:** single/double ceiling, floor, & wall
- **Warranty:** 5 year limited warranty



Offering extremely white and pure light, the CoolSpot II examination light ensures high-intensity and long-lasting bulb life of 600 hours average on standard setting. The guaranteed no-drift arm and removable, autoclavable center Sterihandle design provide easy maneuvering and simple removal to secure sterilization of the exam light for any necessary procedure.

FHC MI-1000 Excel LED Procedure Light

- **Illuminance:** 65,000 lux at 1 meter
- **Color Temperature:** 4300°K
- **Focal Length:** 39'
- **Focusing:** Adjustable by rotating center handle
- **CRI (Color Rendering Index):** 85
- **Rotation:** extension pivots 320° on ceiling
- **8 inner optics:** clear acrylic, multi-source
- **Light Source:** LED
- **Rated life of LED Lamp:** 50,000 hours
- **Mounting Options:** single/double ceiling, floor, & wall
- **Warranty:** 1 year parts & labor warranty



The MI-1000 surgical/procedure light is perfect for users who like long lasting durability and low overall maintenance costs. The FHC MI-1000 LED surgical light combines energy-conscious functionality at an economical price. With very low heat from both light beam and light head and whiter, more natural light, the MI-1000 surgical LED light has the highest efficiency with the lowest power consumption. With an improved level of tissue rendition and excellent shadow control, the MI-1000 surgical light is the cutting edge in surgery light technology.

Transport Stretchers

NEW

FHC7200

**5th WHEEL, 750 lb. CAPACITY
TRANSPORT STRETCHER**



Come see what our stretchers have to offer your facility. Future Health Concept's Transport Stretchers provide the best blend of features, value, and customer support in the industry.

CALL OR EMAIL US TODAY!

www.fhcusa.com

Phone: (888)282-8644

sales@fhcusa.com

**RETRACTABLE CENTER FIFTH
WHEEL PROVIDES STRAIGHT
LINE MOBILITY ALONG WITH
EFFORTLESS PIVOTING
AND CORNERING**

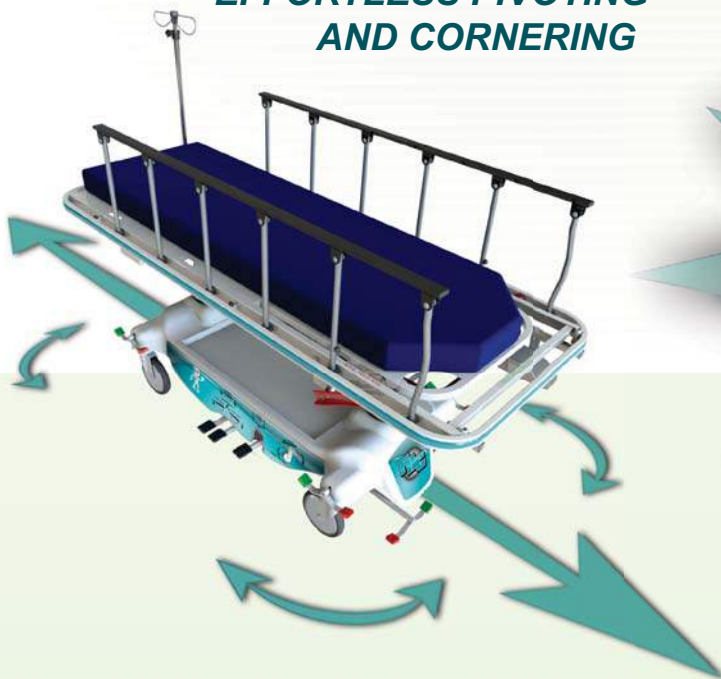

**OMNI-DIRECTIONAL STEERING
MAKES FOR EASY STORAGE
IN TIGHT SPACES**

D1

Transport Stretchers



FHC7200

FHC 7200 MobileCare Transport Stretcher

Standard Features:

- 5th Wheel
- 8" Tente total/directional locking casters
- Brake steer pedals all 4 corners & both ends, 6 total
- Dual cylinder Fowler assist
- Dual pedestal lift mechanism
- Trendelenburg/reverse Trendelenburg
- Lift/Trendelenburg pedals on both sides
- Fold forward side rails w/ built in push handles
- 4" standard mattress
- 2 hook removable slow descent telescopic I.V. pole
- I.V. pole sockets at all corners
- O2 storage underneath stretcher top

Optional Features:

- Fold down push handles
- Manual knee gatch
- Manual Fowler

Specifications:

Overall dimensions: 83" long x 31" wide
Patient surface: 75" long x 26" wide
Height adjustment range: Min 23"/Max 35"
Trend/reverse Trend: +/- 18°
Fowler position: 90°
I.V. attachment sockets: 4
Weight capacity: 750 lbs

Stretcher Pad Specs:

Overall dimensions: 83" long x 31" wide
Patient surface 75" long x 27" wide

FHC7200-31 Extra Wide:

Overall dimensions: 83" long x 35" wide
Patient surface: 75" long x 31" wide

Transport Stretchers



FHC7100

FHC 7100 MobileCare Transport Stretcher

Standard Features:

- 8" Tente total/directional locking casters
- Brake steer pedals all 4 corners
- Single cylinder Fowler assist
- Dual pedestal lift mechanism
- Trendelenburg/reverse Trendelenburg
- Lift/Trendelenburg pedals on both sides
- Fold forward side rails w/ built in push handles
- 4" standard mattress
- 2 hook removable telescopic I.V. pole
- I.V. pole sockets at all corners
- O2 storage underneath

Optional Features:

- Fold down push handles
- Manual knee gatch
- Manual Fowler
- 29" or 31" wide patient surface

Specifications:

Overall dimensions: 83" long x 31" wide
Patient surface: 75" long x 26" wide
Height adjustment range: Min 23"/Max 35"
Trend/reverse Trend: +/- 18°
Fowler position: 90°
I.V. attachment sockets: 4
Weight capacity: 550 lbs

Stretcher Pad Specs:

Overall dimensions: 83" long x 31" wide
Patient surface 75" long x 26" wide

FHC7100-29 Wide:

Overall dimensions: 83" long x 34" wide
Patient surface: 75" long x 29" wide

FHC7100-31 Extra Wide:

Overall dimensions: 83" long x 36" wide
Patient surface: 75" long x 31" wide

Tabletop Sterilizers

Tuttnauer EZ Series Fully Automatic Autoclaves



TUEZ9



TUEZ10

EX9 and EX10 Series:

Item No.	Chamber Dimensions Ø x L In(mm)	Volume	Overall Dimensions DxWxH In(mm)	Standard Cassettes	Tray Dimensions DxWxH In(mm)	No. of Trays	Standard Unwrapped Cycle time	Voltage(V) Freq.(Hz)	Power(W) Current(A)	Shipping Weight lbs(kg)
EZ9™	9" x 18" (230 x 470)	5gal/19L	21.5"x20"x14.4" (545x510x365)	2 full/2 half	16.3"x6.7"x0.8" (415x170x20)	3	Cold: 27 mins Hot: 13 mins	120V 50/60	1400W 12A	95 (43)
EZ10™	10" x 19" (254 x 475)	6gal/23L	21.5"x20"x14.4" (545x510x365)	3 full/3 half	16.3"x6.7"x0.8" (415x170x20)	4	Cold: 30 mins Hot: 14 mins	120V 50/60	1400W 12A	95 (43)
*EZ10k™ Kwiklave™	10" x 19" (254 x 475)	6gal/23L	21.5"x20"x14.4" (545x510x365)	3 full/3 half	16.3"x6.7"x0.8" (415x170x20)	4	Cold: 21 mins Hot: 11 mins	230V 50/60	2200W 10A	95 (43)

*Model EZ10k™ requires a voltage between 220V and 235V for proper operation. When applicable a buck/boost transformer (0.5KVA) may be required.

Features:

- Closed door active drying system to maintain sterility and ensure efficient drying of packs and pouches
- High efficiency air pump circulates air in chamber during drying cycle
- 0.2µm Hepa air filter (replaceable)
- New brighter and easier to read panel
- Program parameters can be customized and stored

Control Panel:



1. Program Selection
2. Detailed Digital Display
3. Programmable Keys
4. System Indicators

Optional Internal Printer



Documents:
date, time,
temperature,
pressure.

TUCB0010



Also Available:

Chamber Brite Autoclave Cleaner

- Pre-measured packets
- Cleans reservoir, chamber & tubing

Tabletop Sterilizers







Tuttnauer EZ+Series Fully Automatic Autoclaves



TUEZ9plus

TUEZ11plus

Tuttnauer EZ Plus Sterilization Programs:

Sterilization programs		Temp.	Hot Cycle Time (fill, heat up and vent)	Sterilization Time (minutes)	Dry Time* (minutes)	Total Hot Cycle Time (Without Dry)	Total Hot Cycle Time (With Dry)
Description	Icon						
Unwrapped Instruments		270°F	EZ9PLUS: 20min. EZ11PLUS: 24min.	3	1	EZ9PLUS: 23min. EZ11PLUS: 27min.	EZ9PLUS: 24min. EZ11PLUS: 28min.
Wrapped Instruments, Pouches		270°F	EZ9PLUS: 17min. EZ11PLUS: 21min.	4	30	EZ9PLUS: 21min. EZ11PLUS: 25min.	EZ9PLUS: 51min. EZ11PLUS: 55min.
Unwrapped Delicate Instruments		250°F	EZ9PLUS: 16min. EZ11PLUS: 19min.	30	1	EZ9PLUS: 46min. EZ11PLUS: 49min.	EZ9PLUS: 47min. EZ11PLUS: 50min.
Handpieces		270°F	EZ9PLUS: 21min. EZ11PLUS: 26min.	4	30	EZ9PLUS: 25min. EZ11PLUS: 30min.	EZ9PLUS: 55min. EZ11PLUS: 60min.
Chamber Brite Cleaning		270°F	EZ9PLUS: 17min. EZ11PLUS: 20min.	3(keep temperature)	N/A	EZ9PLUS: 20min. EZ11PLUS: 23min.	EZ9PLUS: N/A EZ11PLUS: N/A
Custom A**		270°F	EZ9PLUS: 20min. EZ11PLUS: 22min.	4	30	EZ9PLUS: 24min. EZ11PLUS: 26min.	EZ9PLUS: 54min. EZ11PLUS: 56min.
Custom B**		250°F	EZ9PLUS: 13min. EZ11PLUS: 16min.	30	1	EZ9PLUS: 43min. EZ11PLUS: 46min.	EZ9PLUS: 44min. EZ11PLUS: 47min.

* Operator has the option to add additional drying time.

** Custom A and Custom B programs are not FDA cleared. It is the user's responsibility to validate any Custom cycles.

NOTE: cycle times are approximate and may vary depending on instrument loads.

Surgical Scrub Sinks

ES Series Surgical Scrub Sink Features & Options:

Our ES series scrub sinks were developed to be the answer to space and economical constraints. The ES series sinks have a smaller outside dimension, but still have a deep basin to allow for a proper scrub. The operation of the ES sinks are the same as that of the SS series sinks but the features vary.



How to Order Our ES Series Scrub Sinks:

Options Available	Infrared Operation	Manual Bypass to add Knee Operated Water and Soap With IR Operation	Knee Operated Soap With IR Operation (Soap is not a standard feature w/ knee operated water on ES series sinks)	Foot Operated Soap (All Sinks)	Digital Scrub Timer	Eye Wash	220-240V	Pedestal Base
Option Extension	IR	MB	KSP	FSP	TM	EYE	220	PB

Example: Model # FHCES47 Knee Operated Soap and Eye Wash with Pedestal Base = Our Model # FHCES47-KSP-EYE-PB

Surgical Scrub Sink Utility Requirements:

Utility	Connection On Unit	Pressure Range	Temperature	Consumption
Drain	1 1/2" x 6" Tail Piece	N/A	N/A	N/A
Cold Water	1/2" NPT	20-50 PSIG	70 Degree F. Max	2 GPM Per Station
Hot Water	1/2" NPT	20-50 PSIG	180 Degree F. Max	2 GPM Per Station
Electrical (IR Units Only)	120v	N/A	N/A	N/A

Surgical Scrub Sinks

ES Series Surgical Scrub Sink Specifications:

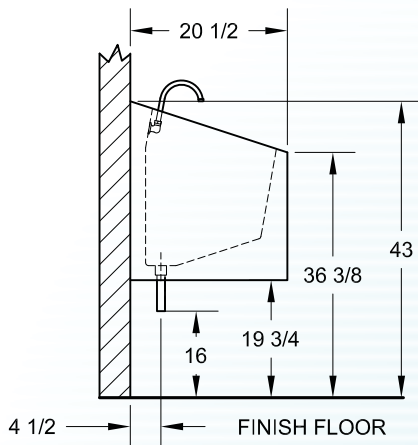

FHCES-25

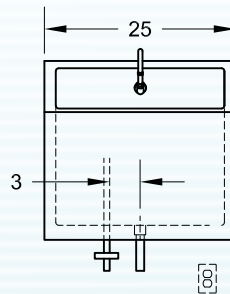

FHCES-25

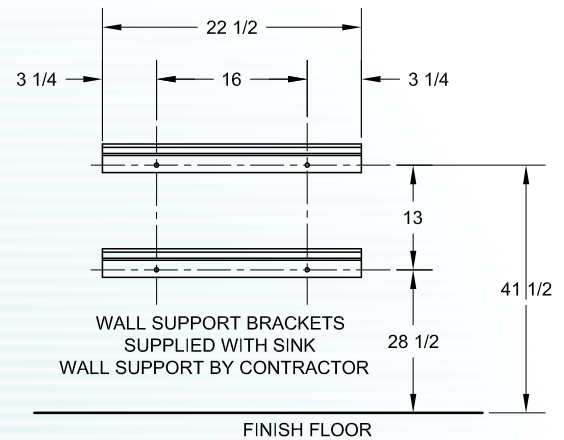

FHCES-47

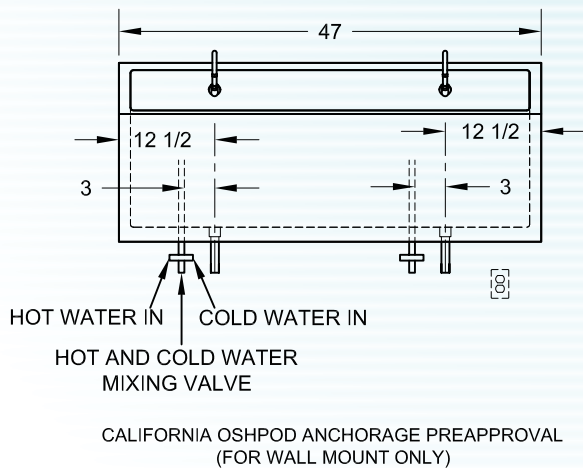

FHCES-47

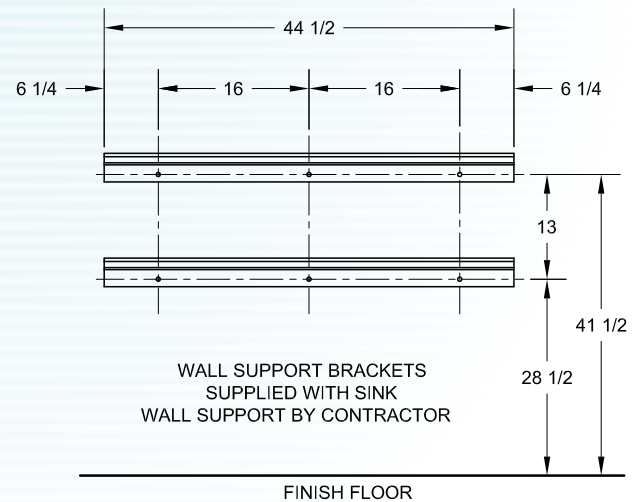

CALIFORNIA OSHPOD ANCHORAGE PREAPPROVAL
(FOR WALL MOUNT ONLY)

Warranty

All Surgical Scrub Sinks manufactured by Future Health Concepts, Inc. will carry a limited lifetime warranty against manufacturing defects and a one year parts and labor warranty. The factory will service all units without cost to the buyer for one year from shipment. After the one year period, replacement of a defective part will be at buyer's expense. We will exchange all defective parts at no cost to the buyer for a period of one year from shipment. All defective parts must be returned within 30 days to ensure proper credit. An RA from Future Health Concepts, Inc. must be obtained prior to items return.

Surgical Scrub Sinks

SS Surgical Scrub Sink Options:

Knee Operated Surgical Scrub Sinks:

To operate the sink, simply press the knee panel one time to activate water flow, press again to stop flow. The soap panel works in a pumping fashion with soap being dispensed through a stainless steel spout located near the mixing valve. The base has been designed to accommodate gallon sized soap container storage behind the knee panels.



Deluxe Surgical Scrub Sinks:

Built as a hybrid, these sinks have dual controls. They are Equipped with an infrared operated water control as well as a manual bypass for knee operated water control. The main operation is via infrared sensor located between the knee panels. The operation for water control is on standby as a backup. In addition, the sink is also equipped with knee operated soap.



Surgical Scrub Sinks

SS Series Surgical Scrub Sink Specifications:

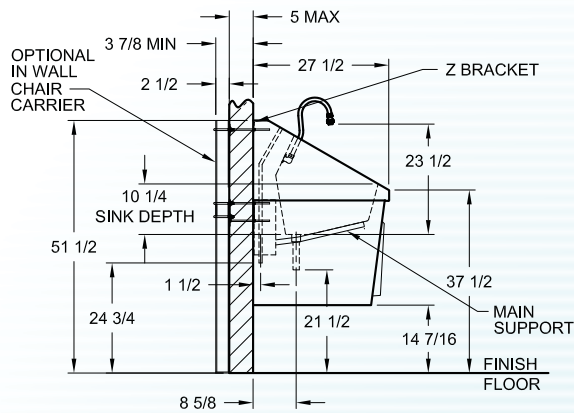

FHCSS-32

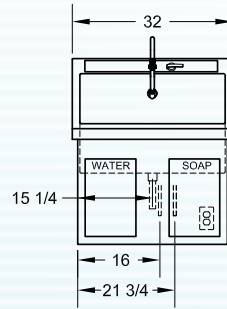

FHCSS-32

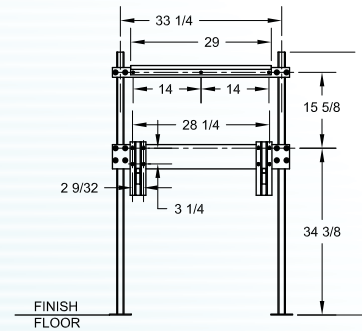

FHCSS-64

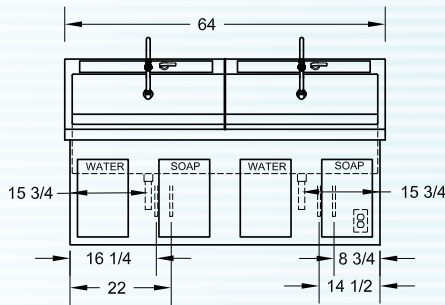

FHCSS-64

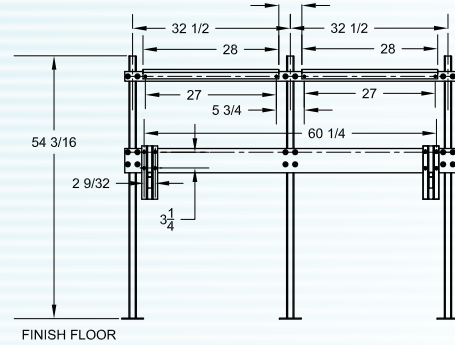

FHCSS-96

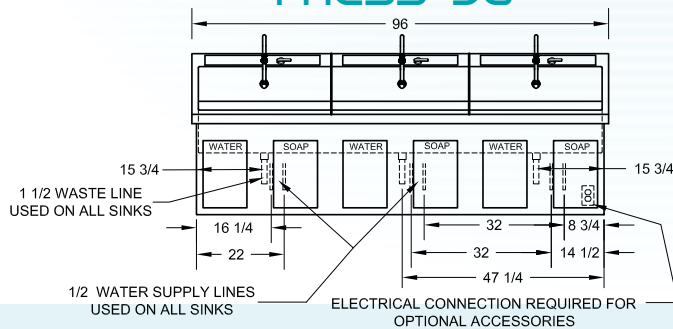

FHCSS-96

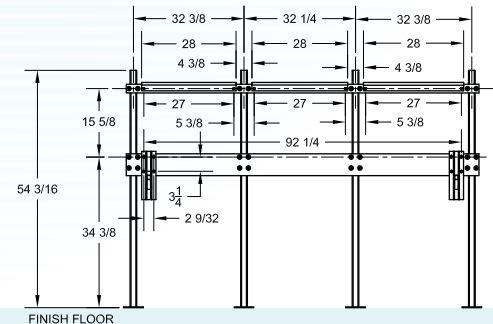

1/2" WATER SUPPLY LINE DETAIL
USED ON ALL SS SERIES SINKS

Anesthesia Machines

FHC offers top quality new anesthesia machines from Penlon.

Penlon Prima 450 Anesthesia System:

- Electronic flow display & conventional flowmeter options available
- AV-S ventilator
- A200SP absorber
- Sigma Delta vaporizer
- Electronic flow display
- 6 ventilation modes
- New top shelf w/ secure GCX mounting system for patient monitors
- Territory-specific electrical outlet options
- Selectactec compatible back-bar (1 or 2 stations)
- Illuminated work space
- Large capacity drawer units
- GCX compatible aluminum uprights for additional accessory mounting
- Integrated CO2 absorber and bellows unit w/ ventilator interface
- HIS connectivity
- Intuitive design in compact footprint
- Low total cost of ownership

2 Year Warranty!



PEPRIMA450

Penlon Prima 460 Anesthesia System:

- Electronic flow display & conventional flowmeter options available
- AV-S ventilator
- A200SP absorber
- Sigma Delta vaporizer
- Electronic flow display
- 6 ventilation modes
- New top shelf w/ secure GCX mounting system for patient monitors
- Territory-specific electrical outlet options
- Selectactec compatible back-bar (2 or 3 stations) w/ interlock on 3 station option
- Up to 4 cylinders
- Illuminated work space with pull-out writing surface
- Large capacity drawer units
- GCX compatible aluminum uprights for additional accessory mounting
- Integrated CO2 absorber and bellows unit w/ ventilator interface
- HIS connectivity
- Intuitive design in compact footprint
- Low total cost of ownership

2 Year Warranty!



PEPRIMA460

Anesthesia Machines

Datex Ohmeda Aespire S/5 7900 Anesthesia Machine:

- Enhanced monitor integration capabilities with Datex-Ohmeda anesthesia monitor
- Optional integrated auxiliary O2 flowmeter and suction control/pressure waveform available
- Advanced breathing system (ABS TM)
- One-step bag/vent switch turns ventilator on/off
- Minimal number of parts and tube connections greatly reduces the potential for leaks and misconnects
- Easy disassembly (no tools required)
- Fully autoclavable and latex-free
- 7900 ventilator s/n - volume and pressure modes with electronic peep
- Exhaled volume airway pressure and inspired oxygen monitoring capabilities
- Direct access to ventilator parameter settings
- Smart alarms direct user to specific problems and affected parameters
- Pressure bar graph for visual reference on a breath-by-breath basis
- Improved low flow/reduced life cycle costs
- Only one scheduled maintenance check per year



Datex Ohmeda Aestiva 5 Anesthesia Machine:

- Enhanced monitor integration
- Lightweight and compact
- Advanced breathing system
- Fully autoclavable and latex-free
- Oxygen monitoring capabilities
- Volume and pressure modes with electronic peep
- Improved low flow/reduced life cycle costs
- Superior 7900 SmartVent technology
- Optional: integrated auxiliary O2 flowmeter and suction control, and pressure waveform available



Drager Narkomed GS Anesthesia Machine:

- Air O2 & N2O flow control assembly with yokes
- Triple exclusion system absorber system complete with hoses & peep system scavenger
- O2-Med FIO2 monitor w/ new fuel cell/sensor cable
- Breathing pressure monitor
- Respiratory volume monitor
- Ave elect. ventilator w/ ascending latex-free bellows & insp. pressure limiter
- ORC O2 ratio monitor
- Drawer assembly w/ central key locking system
- Built-in monitor
- 5" casters w/ front wheel locks
- Nasal O2 flowmeter & vacuum regulator

***One year parts and labor warranty on all refurbished anesthesia machines. Excludes travel time, rubber components, monitor sensors, fuel cells, seals, gaskets and other expendable items. Anesthesia machine warranty service must be performed by FHC or an authorized agent.**

Anesthesia Machine Parts

From ventilators to vaporizers, we have all the anesthesia parts you need.



PE5005005

Penlon Nuffield 200 Ventilator:

- Pneumatically driven time-cycle ventilator
- Preset volume & flow rate for adult or pediatric
- Easy-to-use
- Compact
- Multi-use capabilities - (Co-axial circuit, Ayre's Tee Circuit, Circle System, Resuscitation)
- Use w/ Newton Valve to deliver ultra low tidal volumes for neonates/premature babies

Penlon Sigma Delta Vaporizer:

- Superb performance, particularly at low flow
- Four backbar mounting systems
- Multiple agent and filler block options
- Low body weight
- Key fill, Quik Fil, or Pour fill
- Sevoflurane, Isoflurane, Halothane & Enflurane
- Selectatec, Drager Plug-In, North American Drager, Cagemount
- Internationally recognized
- Award-winning design



PEVS8KS



FHC Fiber Optic Laryngoscope Blades:

- MAFO4310 - Mac #0
- MAFO4311 - Mac #1
- MAFO4312 - Mac #2
- MAFO4313 - Mac #3
- MAFO4314 - Mac #4
- MAFO4315 - Mac #5



FHC Miller, WIS & Paed Fiber Optic Blades:

- MAFO52200 - Miller #00
- MAFO5220 - Miller #0
- MAFO5221 - Miller #1
- MAFO5222 - Miller #2
- MAFO5223 - Miller #3
- MAFO5224 - Miller #4
- MAFO7230 - WIS #0
- MAFO7231 - WIS #1
- MAFO7232 - WIS #2
- MAFO7233 - WIS #3
- MAFO7234 - WIS #4
- MAFO92250 - WIS Pediatric #0
- MAFO92251 - WIS Pediatric #1
- MAFO92251.5 - WIS Pediatric #1 1/2



MAFO8102

FHC Small F.O. Battery Handle:

- Small F.O. battery handle for two AA batteries, complete



MAFO8103

FHC Stubby F.O. Battery Handle:

- Stubby fiber optic battery handle, 2.5v

We carry a full line of anesthesia parts & accessories to accommodate your needs. Ask your rep if we have what your facility needs!

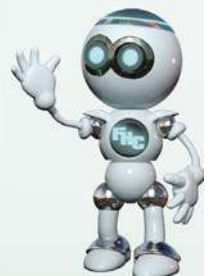

Anesthesia Machine Parts

FHC Continuous Analog Vacuum Regulator:

- Continuous analog vacuum regulator w/ Ohmeda adapter & tubing nipple
- High (0 - 760mm)
- Easy to service and clean
- Smallest & lightest unit on the market (10oz)
- Can be easily upgraded (intermittent/digital)
- Color-coded gauges
- ABS polymer casing is impact resistant & durable
- Same housing for both continuous and intermittent
- Reinforced inlets/outlets
- Removable back plate and gasket
- Can be sterilized internally w/ cold disinfectant
- Designed to meet all current CGA, HCA, & FDA requirements
- Also available with: Chemtron, Puritan Bennet and DISS connectors

***12 Year Warranty!**



Intermittent also available!



Multiple Color Options!



FHCVR-CHUT-OMA

FHC O2 Flowmeter with Ohmeda Adapter:

- Available in USA and ISO colors
- Smallest and lightest chromed brass bodied flowmeter in the industry
- Color-coded inner tube and labeling
- Easy to service
- No strip "D" shape knob
- Includes an inlet filter and inlet extension
- Complete line of flowmeters from neonatal to adult
- Available in standard Thorpe style & Dial style
- Standard 1/8" FNPT connection, but may also be fitted with different adapters & accessories to customize your needs
- MRI options are available
- Available with Chemtron adapter, Ohmeda adapter, Puritan Bennett adapter, and 1/8" NPT female adapter

***5 Year Warranty!**



FHCFM-15UO-OH



Dial Styles:

- Available in Oxygen in 25, 15, 8, & 4 LPM
- Available in Medical Air in 25 & 15 LPM
- Smallest and lightest in the industry
- Small increment is 1/32
- Color-coded labeling for specific gas
- Encased in an anodized aluminum housing
- Easy to read window

Patient Monitors

FHC offers a full line of vital sign & anesthesia monitoring.



Star 60 Color Patient Monitor:

- 10.4" High resolution backlit LED display
- 6-channel Multi-parameter monitor
- Standard parameters: ECG, respiration, dual temperature, NiBP, SpO2 (Nellcor), IBP
- Upgradable to (internal/external), Microstream EtCO2 (with IPI™)
- ST segment analysis & Arrhythmia detection
- Advanced alarm management system including Satseconds™
- WiFi connectivity with Central Nursing Station (Optional)

Star 90 Color Patient Monitor:

- 10 channel sleek, slim monitor
- 15" high resolution (touch) color backlit LED display
- Modular form with inbuilt rack
- Basic configuration: ECG, SpO2, NiBP, dual temperature, dual IBP, respiration
- OxyCRG & Drug dose calculation
- Multiple screen formats w/ auto-format screen
- Adult, pediatric and neonatal applications
- 240 hours of graphical & tabular trends
- External modules and host of pluggable device connectivity
- 2 hours of battery backup
- 24 hrs waveform storage and download
- Specialty module options: NiCCO, EtCO2 (with IPI™)
- WiFi ready
- Wireless connectivity to CNS Skyline 55 & Skyview mini
- Eco-friendly data manager
- Advanced alarm management system



PATIENT MONITORS

Patient Monitors

FHC offers a full line of vital sign & anesthesia monitoring.

Star 55 Color Patient Monitor:

- 8 channel monitor with 12.1" high resolution TFT display
- Adult, pediatric, & neonatal applications
- User selectable display formats & waveform color
- 72 hours tabular & graphical trend
- Multiple communication options (USB, PC dump)
- Go-to & home key for quick access to functions
- Interface with Skyline 55's central monitoring system
- Optional: anesthesia gas monitoring, CO2



LAF386390061027

AGM 55 Module:

- Anesthesia gas monitoring module
- Compatible with Star 90 and Star 55 monitors
- Detection of 5 agents and 3 gases
- Auto detection of primary and secondary agents
- Measurement and display of MAC value



LAF386390056371

Nihon Kohden Cardiofax Interpretive 12-Lead ECG Recorder

- 12-leads at one time
- Selectable ID for record documentation
- Large color screen display
- Internal memory capacity of 40 ECG files
- SD memory card capacity of 3000 ECG files
- Compact design
- Variety of page formats for 12 leads/rhythms
- Light, flexible leadwire adapters
- Accommodates many electrode styles
- Patient cable protects units against high voltage shock
- Initiates recording in 4 seconds
- AC or rechargeable battery operation



NIECG-1350A

***Four Year Warranty**

Patient Monitors

BLT V6 Patient Monitor:

- 7" color, anti-glare TFT LCD display
- Parameters: (NiBP, SpO2, CO2, Temp)
- Recorder
- Two-trace digital field
- Hr/Pr SpO2 NiBP (systolic diastolic & mean)
- Screen display of alarm limits or disable status
- Pr range 20 to 250 bpm
- SpO2 0 - 100% display of plethysmograph
- Pulse strength & SpO2 valves
- Noninvasive blood pressure range 10 to 270 mm hg accuracy +/- 3mm hg
- Instant infrared ear thermometer w/ one box thermometer probe covers
- Alarm settings for all parameters
- 5000 groups NiBP measurement data review
- Rechargeable lithium-ion battery (4000ah)



BIV6-T-R

***One Year Parts & Labor Warranty**

SpotSkan Spot-Check Vital Sign Monitor:

- 6.5" color TFT display
- Capacitive touch keypad
- SpO2 with Plethbar
- Quick temperature measurement
- NiBP measurement
- Pulse rate from SpO2/NiBP
- Adult and pediatric applications
- 12 patients' history storage
- Thermal recorder printer
- Battery back-up



LAF3-85-390-0335-13

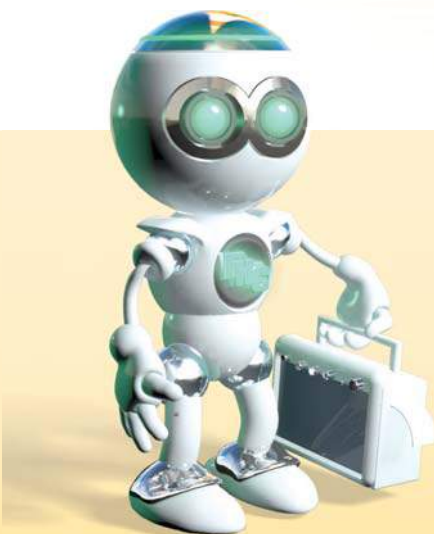

Monitor Stands & Mounts

Medical Monitor Stands:

- Load capacity up to 25 lbs.
- Overall height: 42"
- Sturdy 25" base
- 3" locking casters
- 5" slide-in monitoring plate or VESA 75/100 plate
- Optional accessories available

Part #s:

- Planet 55 - LAFSTAND-55
- Planet - LAFSTAND-P
- Star - LAFSTAND
- Stellar - LAFSTAND-S

***5 Year Warranty!**



AMSSM-150

FHC 22" Double Pivot Monitor Arm:

- 22" extension
- 30 lb. arm rating
- $\pm 30^\circ$ tilt
- Integrated & intelligent cable management
- Tilt and swivel adjustments
- Swivel arm provides lateral functionality
- Compatible w/ Ergotron & Rubbermaid computer carts

***5 Year Warranty**



AMSSM-350

FHC 16" Double Pivot Monitor Arm:

- 16" extension
- 30 lb. arm rating
- $\pm 30^\circ$ tilt
- Integrated & intelligent cable management
- Tilt and swivel adjustments
- Swivel arm provides lateral functionality
- Compatible w/ Ergotron & Rubbermaid computer carts

***5 Year Warranty**



AMSSM-050

FHC Monitor Arm:

- 9" or 12" single arm lengths
- Available for wall channel or rail mounting
- 60 lb. arm rating
- Integrated & intelligent cable management
- Tilt and swivel adjustments
- Swivel arm provides lateral functionality
- Color options available (white is standard)

***5 Year Warranty**

Monitor Accessories



We offer a large selection of brand compatible cables such as: SpO2, ECG, EKG, NiBP, and temperature sensors!

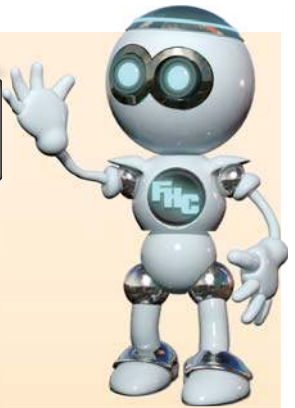

MONITOR ACCESSORIES

SpO2 Cables & Sensors

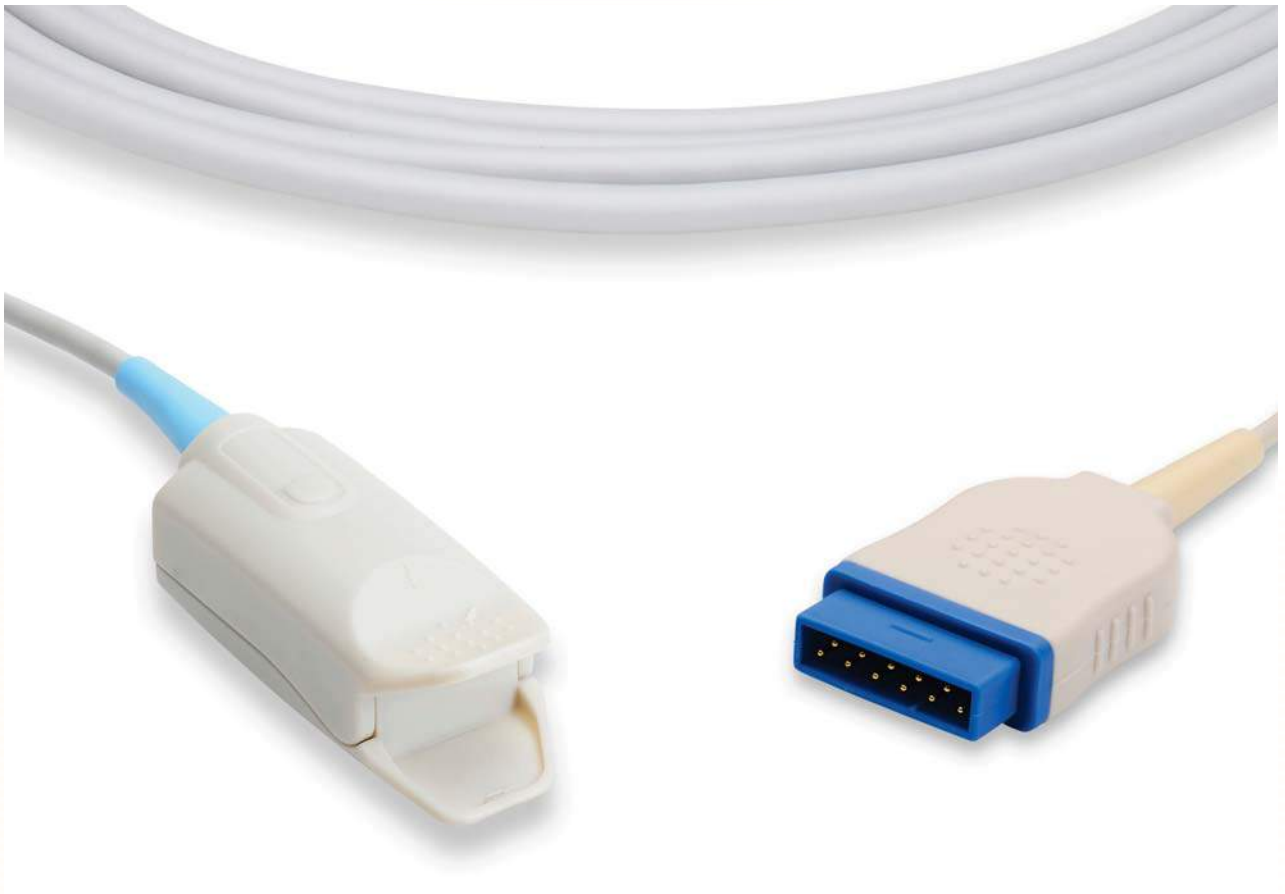

Direct Connect Sensors
9 foot cable



Short Sensors
3 foot cable



Disposable Sensors
3 foot cable



Adapter Cables
1, 4, 7, 8, 10 or 12 feet



SpO2

Compatible SpO2
probes, adapters and
accessories

SpO2 Accessories



SpO₂ Cables & Sensors

Choosing your SpO₂ probe



Adult Clip

Best for a secure grab and for short-term, spot-checking.
Patient size: >85lbs



Adult Soft

Best for patient comfort and long-term care.
Patient size >85lbs



Pediatric Clip

Stronger hold for the little ones that like to move.
Patient size: 30 – 85lbs



Pediatric Soft

A more gentle grab for longer-term monitoring.
Patient size: 30 – 85lbs



Infant Soft

A gentle option for the smaller ones. Patient size: 6 – 30lbs.
Select models only.



Neonate Wrap

Gentle foot wrap for newborns.
Patient size: 2 – 7lbs



Multi-Site

A versatile option for all patient sizes. Apply on foot, finger or ear lobe (with attachment).



Adult Ear Clip

Best choice for patients with low perfusion or burns.
Select models only.





Adult Finger Wrap

An alternative option for adult finger application.
Select models only.







SpO₂ Cables & Sensors

Datascope Adapter Cables



Models	Connector	Options	Part Number	OEM #
Accutorr Plus, Expert, Passport, Accutorr V, DPM Central Station, DPM1, DPM2, DPM3, DPM4, DPM5, DPM6, DPM7, VS-800, PM-50, PM-60, PM-60Vet, N100 (req. preamp cable), N180, N200 (req. preamp cable), N-20, NPB-40, NPB-75, NPB-290, NPB-295, N-390, N-395, N-3000, N-6000, BSM-1102 Life Scope EC, BSM-2304 iPro, BSM-4102 Procyon LT, BSM-4104 Procyon, BSM-4112 Procyon LT, BSM-4114 Procyon, BSM-9510 Life Scope M, OGS-2000 PocketCare	 To Monitor:  		512F-30-28263	512F-30-28263

L&T (Skanray) Adapter Cables (see Nellcor)

Masimo Adapter Cables



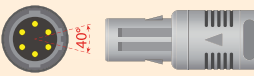

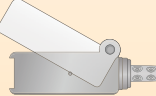

Models	Connector	Options	Part Number	OEM #
Accutorr V, Duo, Passport 2, Passport 2LT, Passport V, Spectrum, Spectrum OR, Trio, V12, V21; Medtronic Physio Control: Lifepak 11, Lifepak 12, Lifepak 15, Lifepak 20, Lifepak 20E; Welch Allyn: Spot Vital Signs 42MTB-E1, 45NE0-E1 LX; Zoll: E Series, M Series, R Series.	To Monitor:  To Sensor: 		0012-00-1599 (10 feet) 0012-00-1652 (4 feet)	0012-00-1599, 0012-00-1652
Reusable sensor for use with an extension cable, and compatible with patient monitors that require LNCS sensors. (Masimo, Mindray, Datascope)	 To Monitor:  		0600-00-0126 (Adult) 0600-00-0127 (Pediatric)	0600,00-0126, 0600-00-0127, 1863 LNCS DCI, 1864 LNCS DCIP, 2653 LNCS DBI, 1895 LNCS TC-I, 2258 LNCS YI
Compatible with Accutorr V, Duo, Trio, Passport 2, Passport V, Spectrum, Spectrum OR, V12, V21			0600-00-0043-01	0600-00-0043-01

Mindray Adapter Cables

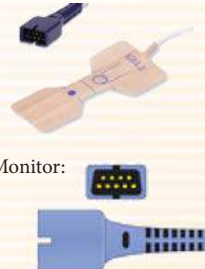

Models	Connector	Options	Part Number	OEM #
MEC 100, MEC 200, PM 7000, 6201, PM 8000, PM 9000, VS-800, Datascope Trio, Accutorr V, Passport V	To Monitor:  To Sensor:  		0010-20-42594	0010-20-42594

SpO₂ Cables & Sensors

Nellcor Adapter Cables

Models	Connector	Options	Part Number	OEM #
Nellcor OEM Oxi-Max DS100A Durasensor, compatible with all monitors that require Nellcor Oxi-Max technology, L&T Star 55, L&T Planet 55, L&T Stellar, L&T Star 50			NEDS100AOEM	DS100A, LAF385100005550
Nellcor MAX-A, MAX-P, MAX-I, MAX-N disposable sensors	 To Monitor: 	Adult Pediatric Infant Neonatal	NEMAXA, NEMAXA-A NEMAXP NEMAXI NEMAXN	MAX-A, MAX-P, MAX-I, MAX-N
Nellcor MAX-FAST			NEMAXFAST	MAX-FAST
All Nellcor models that require Oxi-Max technology such as Dinamap Carescape B650, V100, ProCare, Pro Series, ProSeries V2, Pro 300, Pro 1000, Pro 1000 V3, E-NSAT Modules for i4 Modular Monitors with Oximax option; Fukuda Denshi DS-7100; GE Procare; Omron; Welch Allyn Spot Vital Signs 42NTB-E1, 42NT0-E1 LXI; L&T (Skanray) Star 50, Stellar, Star 55, Planet 55	To Monitor:  To Sensor: 		0012-00-1464 LAF385100005550	DOC-10, WA-DOC-10, 0012-00-1464, F3-85-100-0055-50
Attachment for multi-site sensors to apply pulseox sensor on an adult ear lobe.			NED-YSE	D-YSE

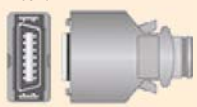
Nihon Kohden Adapter Cables

Models	Connector	Options	Part Number	OEM #
Nihon Kohden BSM-2300 Series, BSM-4100 Series, BSM-5100 Series	To Monitor:  To Sensor: 		NINK-OEM-10	NK-OEM-10, OEM-10

ECG Cables & Leadwires



ECG

Compatible patient cables with 3 and 5 leads, snap or clip (grabber)

One-Piece Cables
11 foot cable



Leadwire Sets
36 inch cables



Trunk Cables
8 foot cable



ECG Cables & Leadwires

Choosing your ECG patient cable



3 Leads Snap

Basic trace reading, stronger connection to electrode press stud.



3 Leads Clip (Grabber)

Easy connection to electrode pad without pressing on patient.



5 Leads Snap

Additional traces, press-on snaps provide secure reading connection reducing false readings.



5 Leads Clip (Grabber)



Additional traces, fast and easy application to electrode pad.

ECG Cables & Leadwires

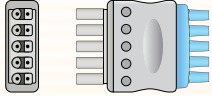



Datascope ECG Leads

Models	Connector	Options	Part Number	OEM #
Expert, Passport 2, Passport 2LT, Passport XG, Spectrum, Trio; Mindray PM 5000, PM 6000, BeneView T5 and BeneView T8		3 Leads Snap	0012-00-1261-09	0012-00-1261-07, 0012-00-1261-08, 0012-00-1261-09
		3 Leads Clip	0012-00-1262-08	0012-00-1262-07, 0012-00-1262-08, 0012-00-1262-09

L&T (Skanray) ECG Leads

Models	Connector	Options	Part Number	OEM #
L&T Monitors: Star 50, Star 55, Planet 55, Galaxy			LACB-84398	LACB-84398
L&T Monitors: Star 50, Star 55, Planet 55, Galaxy			LALW-2810029/3A	LALW-2810029/3A
L&T Monitors: Star 50, Star 55, Planet 55, Galaxy			LALW-3810029/3A	LALW-3810029/3A

Nihon Kohden ECG Leads

Models	Connector	Options	Part Number	OEM #
Nihon Kohden BSM-2300 Life Scope I, BSM-2301, BSM-4100 Life Scope P, BSM-5100 Life Scope A, Life Scope TR, BSM-6000 series, BSM-6301K, BSM-6501K, BSM-6701K, BSM-9510 Life Scope M, BSM-9800 Life Scope S, ZM-900 Series Transmitters, Life Scope 6700 Series	<p>To Patient:</p>  <p>To Monitor:</p> 		NIBR-913PA	BR-913PA
BSM-2300 Life Scope I, BSM-2301, BSM-4100 Life Scope P, BSM-5100 Life Scope A, Life Scope TR, BSM-6000 series, BSM-6301K, BSM-6501K, BSM-6701K, BSM-9510 Life Scope M, BSM-9800 Life Scope S, ZM-900 Series Transmitters, Life Scope 6700 Series.	<p>To Patient:</p>  <p>To Monitor:</p> 		NIJC-906PA	JC-906PA

NIBP Cuffs & Accessories



NIBP

Hoses, reusable and disposable cuffs and connectors

NIBP Hoses
8 foot length



NIBP Cuffs
All patient sizes, reusable and disposable



NIBP Connectors



NIBP Cuffs & Accessories

Nihon Kohden NIBP Hose

Models	Hose	Options	Part Number	OEM #
Life Scope OPV 1500K, BSM-2351A, BSM-4102, BSM-4102A, Life Scope TR, BSM-6000 series, BSM-6301K, BSM-6501K, BSM-6701K, Life Scope J, BSM-9101, PVM-2701		Adult NIBP Hose	NIYP-901P	YN-900P, YN-901P
		Neonate NIBP Hose	NIYP-920	YN-920P, YN-921P

Disposable Datascope/Mindray Monitor NIBP Cuffs

Description	Hose	Options	Part Number
Disposable, OEM Mindray/Datascope monitor cuffs, sold individually. Rectus connector.		Adult (25-35cm) Single Hose	0683-14-0003-01
		Large Adult (33-47cm) Single Hose	0683-14-0004-01
		Child/Small Adult (18-26cm) Single Hose	0683-14-0002-01

Disposable Star 50 Monitor NIBP Cuffs

Description	Hose	Options	Part Number
Disposable, Star 50 monitor cuffs, sold individually. Comes with twist connector.	 (BP Cuff included, not shown)	Adult (25-35cm) Single Hose	0661-5130
		Large Adult (33-47cm) Single Hose	0661-5135
		Child/Small Adult (18-26cm) Single Hose	0661-5131
		Infant (10-19cm) Single Hose	0661-5132

Disposable Star 55 Monitor NIBP Cuffs

Description	Hose	Options	Part Number
Disposable, Star 55 monitor cuffs, sold individually. Comes with male rectus connector.	 (BP Cuff included, not shown)	Adult (25-35cm) Single Hose	0661-5130OC
		Large Adult (33-47cm) Single Hose	0661-5135OC
		Child/Small Adult (18-26cm) Single Hose	0661-5131OC
		Infant (10-19cm) Single Hose	0661-5132OC

Disposable Nihon Kohden NIBP Cuffs

Description	Hose	Options	Part Number
Disposable, Star 55 monitor cuffs, sold individually. Male rectus connector.	 (BP Cuff included, not shown)	Adult (25-35cm) Single Hose	0661-5130MCPC
		Large Adult (33-47cm) Single Hose	0661-5135MCPC
		Child/Small Adult (18-26cm) Single Hose	0661-5131MCPC
		Infant (10-19cm) Single Hose	0661-5132MCPC

NIBP Cuffs & Accessories

All Size Reusable NIBP Cuffs

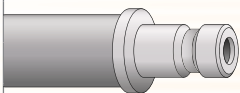
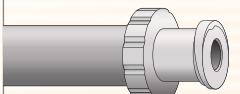
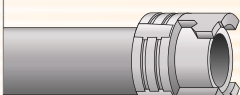

Description	Hose	Options	Part Number
Datascope, Drager, Philips, Siemens, and Spacelabs monitors. Sold in cases of 5 units. Each cuff comes with a moulded BP12 plastic NIBP connector.	 <p>(BP Cuff included, not shown)</p>	Adult (23-33cm) Single Hose	0661-1880SS0CNL
		Large Adult (31-40cm) Single Hose	0661-1869SS0CNL
		Small Adult (17-25cm) Single Hose	0661-1881SS0CNL
		Infant (8-13cm) Single Hose	0661-1882SS0CNL
		Thigh (38-50cm) Single Hose	0661-1884SS0CNL
Colin, Datascope and Spacelabs monitors. Available in cases of 5 units. Each cuff comes with a moulded BPO3 plastic NIBP connector. Non-latex.	 <p>(BP Cuff included, not shown)</p>	Adult (23-33cm) Single Hose	0661-1880SLLNL
		Large Adult (31-40cm) Single Hose	0661-1869SLLNL
		Small Adult (17-25cm) Single Hose	0661-1881SLLNL
		Infant (8-13cm) Single Hose	0661-1882SLLNL
		Thigh (38-50cm) Single Hose	0661-1884SLLNL
	 <p>(BP Cuff included, not shown)</p>	Adult (25-35cm) Single Hose	NIYP-963T
		Large Adult (33-47cm) Single Hose	NIYP-964T
		Small Adult (18-26cm) Single Hose	NIYP-962T
		Infant (8-13cm) Single Hose	NIYP-960T
		Thigh (38-50cm) Single Hose	NIYP-965T

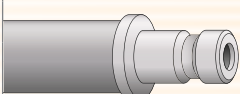
Reusable Datascope/Mindray NIBP Cuffs

Description	Hose	Options	Part Number
Reusable, OEM Datascope/Mindray cuffs, sold individually. Recuts connector.	 <p>(BP Cuff included, not shown)</p>	Large Adult Long (35.5-46cm) Single Hose	0683-15-0007-01
		Large Adult (33-47cm) Single Hose	0683-15-0004-01
		Adult Long (27.5-36.5cm) Single Hose	0683-15-0006-01
		Adult (25-35cm) Single Hose	0683-15-0003-01
		Child/Small Adult (18-26cm) Single Hose	0683-15-0002-01
		Infant (10-19cm) Single Hose	0683-15-0001-01
		Thigh (46-66cm) Single Hose	0683-15-0005-01

NiBP Cables & Accessories

NIBP Connectors

Connector	Image Src	Description	Part Number
NIBP Connector		NIBP luer-lock connector for use with Mennen (Old), Shchiller, Spacelabs (Old). Connects to ADCN-BP06	ADCN-BP03
NIBP Connector		NIBP luer-style connector for use with Mennen (Old), Shchiller, Spacelabs (Old). Connects to ADCN-BP07.	ADCN-BP04
SSNL NIBP Connector		NIBP connector for use with CAS Med, Drager, Kontron, Physio Control (Old), Schiller. Connects to all SSNL . Generally used for neonate cuffs.	0661-2921
NIBP Connector		NIBP connector for use with Criticare, Datascope, Drager, Siemens, Physio Control, Mindray, Philips, Spacelabs. Connects to ADCN-BP15.520.	ADCN-BP13.316
NIBP Connector		NIBP connector for use with Criticare, Datascope, Drager, Siemens, Physio Control, Mindray, Philips, Spacelabs. Connects to ADCN-BP15.520.	ADCN-BP12
NIBP Connector		NIBP bayonet-style connector for use with Schiller and Infinium One. Connects to ADCN-BP12.	ADCN-BP15.520
NIBP Connector		NIBP quick-connect connector for use with Datex Ohmeda, Marquette, Zoll M Series. Connects to ADCN-BP18.	ADCN-BP17
NIBP Connector		NIBP quick-connect connector for use with Datex Ohmeda, Marquette, Zoll M Series. Connects to ADCN-BP17.	ADCN-BP18

Monitor Paper

Manufacturer Instrument Model/Name	Manufacturer item ID	Format	Dimensions	Grid	Type	Ut/Pk
Datascope Passport 2, EL., Spectrum	0683-00-0422-02	ROLL	50 x 30.48 (100)	BLANK	PAPER, DT, P	10
Datascope Trio, Passport V	0683-00-0505-02	ROLL	50 x 25.9 (85)	BLANK	PAPER, DT, P	10
L&T (all monitors)	LA389100001049	ROLL	57 x 16.76 (55)	BLANK	PAPER, DT, P	10
Nihon Kohden	NIFQW-50-3-100	F-FOLD	50 x 100 x 300	ORANGE	PAPER, DT, P	10
Tuttnauer (autoclave)	TU01610406	ROLL	57 x 16.76 (55)	BLANK	PAPER, DT, P	10
Zoll "M" Series Defibrillators	ZO8000-0302	F-FOLD	91 x 90 x 200	RED	PAPER, DT, P	2

We also carry batteries for your medical equipment from patient monitors to surgical tables from these select manufacturers:

Amsco, Baxter, Berchtold, Biodex, Burdick, Castle, Critikon, Datascope, Datex Ohmeda, Dinamap, Eschmann, GE, Gomco, L&T, Marquette, Medfusion, NarkoMed, Nihon Kohden, Olympus, Physio Control, Champagne, Skytron, Steris, Stryker, Welch-Allyn, Zimmer, & Zoll

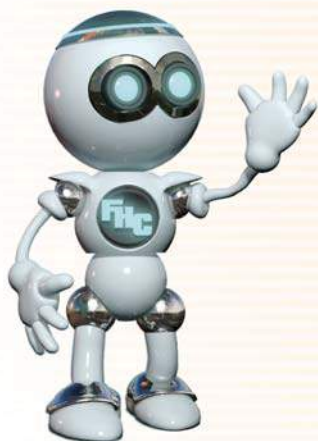

We carry all the monitor and sterilizer paper you need. If you don't see what you're looking for, ask your sales rep if we carry the right medical paper for you.

Defibrillators

Zoll M Series Biphasic Defibrillator w/ Pacing

GENERAL

- Size: 6.8" (17.3 cm) H x 10.3" (26.2 cm) W x 8.2" (20.8 cm) D
- Weight: 11.5 lbs (5.23 kg) with Multi-Function Cable and battery; 13.5 lbs (6.14 kg) with paddles
- Design Standards: Meets or Exceeds UL Standards

ECG MONITORING

- Patient Connection: 3, 5 or 12 -lead ECG cable, paddles or MFE Pads.
- Bandwidth: 0.5-40 Hz (-3 dB) or 0.5-30 Hz; 0.05-150Hz diagnostic
- ECG Size: 0.5, 1, 1.5, 2, 3 cm/ mV – display on monitor
- Heart Rate: Digital display 0-3000 bpm \pm 5%

DISPLAY

- Screen Type: High-resolution display
- Screen Size: 5.6" (14.2cm) diagonally
- Sweep Speed: 25mm/ sec
- Viewing Time: 4 seconds
- Channels: 2

DEFIBRILLATOR

- Waveform: Damped Sinusoid or Zoll Rectilinear Biphasic
- Energy Selection: Selectable 1, 2, 3, 4, 5, 6, 7, 8, 9, 10, 15, 20, 30, 50, 75, 100, 150, 200, 300, 360 joules. (Delivered into 50 Ω load.)
- Charge Time: Less than 7 seconds with new fully charged battery
- Paddles: External anterior/anterior adult and pediatric



ZOMBP



ZOMCCTBPSNI

Zoll M Series Biphasic Defibrillator w/ SpO2, NIBP, IBP Advisory AED

- ZOLL XL battery for long transport times
- Transport-ready design
- Easy-to-read-display
- Full range of parameters for a full range of patients
- Flexible color display
- Quick, easy connections
- Ready to gather and share critical data



ZOAED-PLUS

Zoll AED+ Defibrillator

- Lightweight of 6.7 lbs.
- Easily identifiable green exterior
- Uses low-cost consumer batteries
- Voice prompts provide feedback and encouragement
- LED lights show rescuer proper steps in order
- One piece CDR-D padz



FHC-LIFEPAK12-B

Physio Control Lifepak 12 Biphasic Defibrillator w/ Pacing

- Compact and portable
- Choice of standard, pediatric, and or sterilizable internal and external paddles
- Compatible w/ QUIK-COMBO® pacing/defibrillator/ECG electrodes
- Masimo SET® pulse oximetry offers accurate and stable oxygen saturation monitoring
- Oscillometric (NiBP) monitoring
- End-tidal CO2 (EtCO2) monitor
- GE Marquette 12SL™ ECG analysis program
- Either 50mm or 100mm printers
- Data Storage: up to 50 patient records

Medical Carts

FHC offers a full line of medical, crash, anesthesia carts, cart packages, & cart accessories to ensure all your medical cart needs are met! Each of our cart packages & accessories are sold separately to allow customers to customize individual carts to their specific needs.

Medical Cart Features:

- Antimicrobial properties built in to protect portions of the product.
- Double wall construction
- Ball bearing slides with quick release
- Easy grip solid poly handles
- Stabilizer base w/ high impact, non-marking plastic bumper to add stability and keep cart from tipping
- 5" Premium easy roll casters (2 braking, 1 tracking, 1 swivel)
- ABS plastic top
- Premium latex-free powder coat paint
- Pre-threaded holes on side & back to easily mount accessories

Drawer Configurations: 3, 4, 5, or 6 drawers available for most carts. Pediatric carts available in 9 or 10 drawers.



FXRL-433669-RED

Locking Options Available:

- Key lock
- Push button lock
- Lever/Breakaway lock
- Electronic lock
- Proximity lock



FTGS-433369-DKB

(Traditional Steel shown)

Small, easy-to-clean & removable work surface.

Pre-drilled holes to mount accessories.

Advanced nylon reinforced poly carbonate bumper offers a wider wheel base for more stability while offering superior protection. Single piece construction that resists scuffs & scratches.

5" Premium "Easy-roll" sealed bearing casters with precision bearing swivels. Thread guards minimize sutures and other materials from collecting around axles and keep carts rolling smooth.

Medical Carts

Drawer Colors Available for Most Carts:



Available Cart Sizes:

ALUMINUM:



Elite Aluminum Unicarts:
29"W x 24.5"D
(Includes stabilizer base)
Drawer interior dimensions:
22"W x 16.5"D

Elite Aluminum Med-Jr. Carts:
23"W x 24.5"D
(Includes stabilizer base)
Drawer interior dimensions:
16.5"W x 16.5"D

STEEL:



Steel Unicarts:
29"W x 24.5"D
(Includes stabilizer base)
Drawer interior dimensions:
22"W x 16.5"D
*Includes required 4" top drawer

Steel Med-Jr. Carts:
23"W x 24.5"D
(Includes stabilizer base)
Drawer interior dimensions:
16.5"W x 16.5"D

Medical Carts

Cross Reference Spec Chart:

CART FRAME DATA					DRAWER DATA				SECURITY	
FRAME STYLE	OVERALL DIMENSIONS	WEIGHT RANGE (lbs)	EXTERIOR COLORS	PULL-OUT SHELF	DRAWER INSIDE DIMENSIONS	DRAWER SIZES (inches high)	BUILT-IN DIVIDERS	DRAWER COLORS	LOCK OPTIONS	ANTI-MICROBIAL
ALUMINUM UNICART										
Short	36"h x 29"w x 24.5"d	65-90	LTG, RED, ELB	Yes	22"w x 16.5"d	3, 6, 9, 12	Yes	All 16 Options	Lever, Key, Pushbutton, Electronic, Proximity Card	Yes
Medium	39"h x 29"w x 24.5"d	70-95	LTG, RED, ELB	Yes	22"w x 16.5"d	3, 6, 9, 12	Yes	All 16 Options	Lever, Key, Pushbutton, Electronic, Proximity Card	Yes
Tall	42"h x 29"w x 24.5"d	75-95	LTG, RED, ELB	Yes	22"w x 16.5"d	3, 6, 9, 12	Yes	All 16 Options	Lever, Key, Pushbutton, Electronic, Proximity Card	Yes
X-Tall	45"h x 29"w x 24.5"d	80-100	LTG, RED, ELB	Yes	22"w x 16.5"d	3, 6, 9, 12	Yes	All 16 Options	Lever, Key, Pushbutton, Electronic, Proximity Card	Yes
STEEL UNICART										
Short	37.5"h x 29"w x 24.5"d	85-100	LTG, RED, ELB	No	22"w x 16.5"d	3, 4, 6, 9, 12, Panel	No	All 16 Options	Lever, Key, Pushbutton	Yes
Medium	40.5"h x 29"w x 24.5"d	85-100	LTG, RED, ELB	No	22"w x 16.5"d	3, 4, 6, 9, 12, Panel	No	All 16 Options	Lever, Key, Pushbutton	Yes
Tall	43.5"h x 29"w x 24.5"d	90-120	LTG, RED, ELB	No	22"w x 16.5"d	3, 4, 6, 9, 12, Panel	No	All 16 Options	Lever, Key, Pushbutton	Yes
X-Tall	46.5"h x 29"w x 24.5"d	100-140	LTG, RED, ELB	No	22"w x 16.5"d	3, 4, 6, 9, 12, Panel	No	All 16 Options	Lever, Key, Pushbutton	Yes
ALUMINUM BEDSIDE/MED JR.										
Short	36"h x 23"w x 24.5"d	60-80	LTG	Yes	16.5"w x 16.5"d	3, 6, 9, 12	Yes	All 16 Options	Lever, Key, Pushbutton, Electronic, Proximity Card	Yes
Medium	39"h x 23"w x 24.5"d	60-85	LTG	Yes	16.5"w x 16.5"d	3, 6, 9, 12	Yes	All 16 Options	Lever, Key, Pushbutton, Electronic, Proximity Card	Yes
Tall	42"h x 23"w x 24.5"d	65-85	LTG	Yes	16.5"w x 16.5"d	3, 6, 9, 12	Yes	All 16 Options	Lever, Key, Pushbutton, Electronic, Proximity Card	Yes
X-Tall	45"h x 23"w x 24.5"d	70-90	LTG	Yes	16.5"w x 16.5"d	3, 6, 9, 12	Yes	All 16 Options	Lever, Key, Pushbutton, Electronic, Proximity Card	Yes
STEEL BEDSIDE/MED JR.										
Short	36"h x 23"w x 24.5"d	80-95	LTG	No	16.5"w x 16.5"d	3, 6, 9, 12	No	All 16 Options	Lever, Key, Pushbutton, Electronic, Proximity Card	Yes
Medium	39"h x 23"w x 24.5"d	80-95	LTG	No	16.5"w x 16.5"d	3, 6, 9, 12	No	All 16 Options	Lever, Key, Pushbutton, Electronic, Proximity Card	Yes
Tall	42"h x 23"w x 24.5"d	85-115	LTG	No	16.5"w x 16.5"d	3, 6, 9, 12	No	All 16 Options	Lever, Key, Pushbutton, Electronic, Proximity Card	Yes
X-Tall	45"h x 23"w x 24.5"d	90-130	LTG	No	16.5"w x 16.5"d	3, 6, 9, 12	No	All 16 Options	Lever, Key, Pushbutton, Electronic, Proximity Card	Yes

Cart Size Options:

1. Choose a cart size (Short, Tall, X-Tall)
2. Select any combination of 3", 6", 9" or 12" drawers that fit within your cart's configurable drawer space.
3. Select drawer front colors based on color options below.

Build Your Part Number: (Ex: FTGKA-33669-RED)

Section 1 Letters:

- 1..."F" (for FHC cart)
- 2..."S" = Short, "M" = Medium, "T" = Tall, "X" = X-tall exterior
- 3..."B" = Blue, "G" = Lt. Gray, "R" = Red exterior ("W" = wood, Tall exteriors only)
- 4..."K" = key, "L" = lever, "S" = simplex, "E" = electronic, "P" = proximity
- 5..."A" = aluminum (Traditional Steel if no 5th letter)

Section 2 Letters:

- 1...Height of 1st drawer
- 2...Height of 2nd drawer
- 3...Height of 3rd drawer
- 4...Height of 4th drawer, etc.

(Total for sec. 2 must = 21in. for short cart; 27in. for tall cart; 30in. for X-tall cart)

Section 3 Letters: (3 letters signify color choice for drawer fronts. See page 2 of carts for color choices)



Medical Cart Accessories

Drawer Accessories:



2.5" Deep Configurable Gray Plastic Divider Tray

2.5" deep, includes dividers. Fits 2 per drawer, and typically used in 3" and 4" deep drawers.

9.25"W x 15"D x 2.5"H

FWDC-2025



4.75" Deep Configurable Gray Plastic Divider Tray

4.75" deep, includes dividers. Fits 2 per drawer, and typically used in 6", 9", and 12" deep drawers.

9.25"W x 15"D x 2.5"H

FWDC-2050



Lightweight Backside Cardiac Board Mount

Lightweight plastic cardiac board and metal mounting brackets for back side of Steel Unicart. Please see FCBB-7 for Aluminum Unicarts, FCBB-PC345 for FPC343 & FPC345. 24"W x 1"D x 18"H

FCBB-6



Oxygen Tank Mount

Plastic oxygen tank brackets with adjustable Velcro straps. For all Unicarts or Med Jr carts. For FPC343 or FPC345.

Please use part # FOTB-PC345.

FOTB-4



Metal Oxygen Tank Bracket

Can be mounted to all Unicarts and Med Jr carts.

FOTB-5



IV Pole

Chrome IV pole and mounting bracket. Mounts on Unicart, Med Jr, Medtrix, and DMC. For FER2000 please use part # FIV-3

FIV-2



Utility Hooks

Mounts to existing holes on either side or back of cart. 2 hooks per package.

FUH-2



Small Waste Basket

Small (6 qt.) plastic waste basket. Requires accessory rail.

9"W x 6.25"D x 8.8"H

FBSK-1



Large Waste Basket

Large (20 qt.) plastic waste basket. Requires accessory rail.

13"W x 8.5"D x 15"H

FBSK-2



Tilt Bins

Clear plastic tilt bins with white exterior. Available in 3, 4, 5, or 6 bin units. Mounts to base rail systems (FBRS-2, FBRS-3, or FBRS-JR)

**FTB-3
FTB-4
FTB-5
FTB-6**

Medical Cart Accessories

Drawer Accessories: (Continued)



Horizontal Rail System

For hanging accessories and mounting shelves on Unicarts. Includes 2 vertical and 3 horizontal rails.

FBRS-2 - Steel or Aluminum carts
FBRS-JR - Med Jr. carts



Wrap-Around Aluminum Railing

May be used to hang accessories.

FR-3 - Steel carts
FR-4 - Aluminum carts
FR-JR - Med Jr. carts



Collapsible Side Shelf

For Steel Unicart & Med Jr. Hangs on either side of cart.
Surface area: 17.5"W x 15"D

FSSG-2C



Accessory Side Rail

For Steel Unicarts or Steel Med-Jr carts. Rails for mounting various accessories to side of cart.

FSR-1



Accessory Back Rail

For Steel Unicarts or Steel Med-Jr carts. Rails for mounting various accessories to back of cart.

FCB-1



Plastic Cart Cover

For Unicarts. Includes 5 bags. Dimensions: 33" x 23" x 42"

FBAG-COVER5



Plastic Breakaway Seals

Can be used with lever locking systems, breakaway gate locks and FEMER-BOX divider trays.

FPS-100

Example Cart Configuration:

FTRL-43336P-RED



Tables

Instrument & Back Tables:

Not only are our instrument tables made from the highest quality stainless steel available, they are also manufactured to cater to all of your specific space requirements to fit your facility's needs.

Standard Features:

- Fully-welded construction
- Reinforced tops
- Durable 1 1/4" 16 gauge stainless steel legs
- 16 gauge type 304 stainless steel top
- 18 gauge type 304 stainless steel under shelf
- 2" swivel casters

Options:

- 3" swivel casters
- Locking casters
- Drawers under all sizes
- Stainless steel guard rails
- H or U brace instead of under shelf
- Nesting sets
- Multiple under shelves

Standard Models:

Model #	Width	Depth	Height
FHC8018	16	20	34
FHC8016	16	30	34
FHC8010	24	36	34
FHC8008	24	48	34
FHC8004	24	60	34
FHC8000	24	72	34



Custom sizes available upon request

Example Table Configurations:



FHC8016

Table with H-Brace



FHC8004

Table with Under Shelf



FHC8000

Table with U-Brace

Utility Tables/Prep Stands:

Standard Features:

- Fully-welded construction
- Reinforced tops
- Durable 1 1/4" 16 gauge stainless steel legs
- 16 gauge type 304 stainless steel top
- 18 gauge type 304 stainless steel under shelf
- 2" swivel casters

Options:

- 3" swivel casters
- Locking casters
- Drawers under all sizes
- Stainless steel guard rails
- H or U brace instead of under shelf
- Nesting sets
- Multiple under shelves

Available in 4 models: single, double, triple, or four drawers
Size: 16"D x 20"W x 34"H



FHC8153



FHC8152



FHC8151



FHC8150

(Models shown with optional locking casters)

Custom sizes available upon request

Mayo Stands

FHC Foot Operated Dual Post Mayo Stand:

- Fully-welded stainless steel construction
- Double-post design
- Removable 21 1/4" x 16 1/4" stainless steel tray
- Foot operated friction lock height adjustment/dual post
- 2" casters

FHC8867SS - same as above, except with 19 1/8" x 12 5/8" stainless steel tray

FHC8871SS - same as above, except with 25" x 20" stainless steel tray



FHC Hand Operated Dual Post Mayo Stand:

- Fully-welded stainless steel construction
- Double-post design
- Removable 21 1/4" x 16 1/4" stainless steel tray
- Hand operated friction lock height adjustment/dual post
- 2" casters

FHC8767SS - same as above, except with 19 1/8" x 12 5/8" stainless steel tray

FHC8771SS - same as above, except with 25" x 20" stainless steel tray

Optional: Mobile Base (-MB)



Solution Stands



FHC Single Basin Ring Stand:

- Fully-welded stainless steel construction
- Overall size: 14"D x 14"W x 34"H
- Removable 7 quart stainless steel basin
- 2" casters cap swivel
- Accessible from any side with open frame design

FHC7809HB - optional 8 1/2 quart basin

Also available with lower stainless steel shelf - **FHC7807SS**

FHC Double Basin Ring Stand:

- Fully-welded stainless steel construction
- Overall size: 14"D x 28"W x 34"H
- Two removable 7 quart stainless steel basins
- Stainless steel lower shelf
- 2" casters cap swivel
- Accessible from any side with open frame design

FHC7810SS - optional 8 1/2 quart basin

Also available without stainless steel shelf - **FHC7808HB**



IV Stands

Constructed with fully welded stainless steel and tip-resistant base, the FHC IV stands are built with durability and reliability in mind. The FHC1315 and FHC1415 series IV poles give customers the option between hand or foot operated adjustment and the number of hooks to be included.

FHC1315 Series Hand Operated I.V. Pole:

- Fully welded stainless steel construction
- 2" swivel casters
- Tip resistant base
- 68" - 108" height adjustment
- Hand operated
- Five leg stand

FHC1315-2 - 2 hook design

FHC1315-4 - 4 hook design

FHC1315-6 - 6 hook design

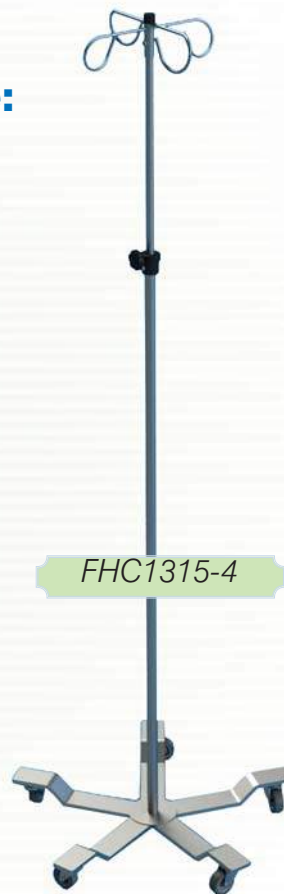

FHC1415 Series Foot Operated I.V. Pole:

- Fully welded stainless steel construction
- 2" swivel casters
- Tip resistant base
- 68" - 108" height adjustment
- Foot operated
- Five leg stand

FHC1415-2 - 2 hook design

FHC1415-4 - 4 hook design

FHC1415-6 - 6 hook design



FHC1410 4-Leg Series I.V. Pole:

- 2" swivel casters
- Tip resistant base
- 68" - 108" height adjustment
- Hand operated
- Four leg stand
- Knocked-down design for low-cost shipping

FHC1410-2 - 2 hook design

FHC1410-4 - 4 hook design

FHC1410-6 - 6 hook design



FHC1510 5-Leg Series I.V. Pole:

- 2" swivel casters
- Tip resistant base
- 68" - 108" height adjustment
- Hand operated
- Five leg stand
- Knocked-down design for low-cost shipping

FHC1510-2 - 2 hook design

FHC1510-4 - 4 hook design

FHC1510-6 - 6 hook design



Also available:

FHC1610 - Six leg stand with 2, 4, or 6 hook design options

Linen Hampers

FHC Small Triangular Hamper:

- Fully welded, heavy gauge stainless steel construction
- 3" double ball bearing, swivel casters
- Full, heavy gauge stainless steel platform to support bags & ease of removal
- Overall size: 35"H x 57 1/4" perimeter
- Accommodates 18" diameter bags
- Available with foot control (FHC2301SS-FC)
- Larger hamper for 25" diameter bags available

Options:

- Foot operated stainless steel lid
- Rotating bumper guards over casters



FHC2301SS

FHC Large Circular Hamper:

- Fully welded, heavy gauge stainless steel construction
- 3" double ball bearing, swivel casters
- Full, heavy gauge stainless steel platform to support bags & ease of removal
- Overall size: 35"H x 25" diameter
- Accommodates 25" diameter bags
- Available with foot control (FHC2202SS-FC)
- Smaller hamper for 18" diameter bags available

Options:

- Foot operated stainless steel lid
- Rotating bumper guards over casters



FHC2202SS

Chrome Step-on Hamper w/ Lid:

- Lid dimensions: 18.63"W x 19.5"D
- Hamper height: 37.75"H
- White, polycoated steel lid
- Non-slip foot pedal
- Lid-locking ability for open position
- Supports 36 - 42 gallon bags (not included)
- Metal ring to keep bags in place
- Hamper bag storage pouch
- 3" hard wheel casters (2 locking)



2010

Footstools

EZ Stacking Interlocking Step Stool:

- Dimensions: 12"D x 18"W x 5"H
- Slip proof rubber tread surface
- Tip resistant
- Stools can interlock to form desired size platform
- Stools are stackable for increased height and storage
- Fully welded stainless steel construction

***Also Available:** FHC145 - Stacking Stool Carry Cart



Chrome Rigid Footstool

- Dimensions: 11 3/8"D x 14 1/4"W x 9 1/2"H
- Triple chrome plated steel
- All welded steel construction
- 17 weld points on each stool
- Non-slip black rubber mat
- Metal washers inside rubber tips to protect flooring surfaces



Chrome Rigid Footstool with Handle

- Dimensions: 11 3/8"D x 14 1/4"W x 9"H
- Measures 35 3/4" from top of rail to floor
- Triple chrome plated steel
- All welded steel construction
- 17 weld points on each stool
- Non-slip black rubber mat
- Metal washers inside rubber tips to protect flooring surfaces



Kick Buckets

FHC 8.5 Quart Kick Bucket:

- Overall size: 8"H x 16 1/4" diameter
- Removable 8 1/2 quart stainless steel basin
- Stainless steel frame
- Perimeter bumper to protect walls
- 2" swivel casters
- Tip resistant



FHC7768SS

FHC 12 Quart Kick Bucket:

- Overall size: 14"H x 13 1/2" diameter
- Removable 12 quart stainless steel basin
- Stainless steel frame
- Perimeter bumper to protect walls
- 2" swivel casters
- Tip resistant



FHC7766SS

Exam Tables

Exam Tables:

5240 Series Exam Table

- Seamless upholstery with antimicrobial guard
- Easy-reach articulating back adjustment
- One touch, easy-glide comfort stirrups with 3 lateral positions and fracture lock length adjustment
- Slide-out leg section with removable leg rest
- Removable 9" x 9" plastic drip pan
- Pull-out all steel non slip front step 7" high
- Paper roll holder (21")
- 2 front and 2 reversible storage drawers on full extension roller bearing drawing glides
- Leveling glides
- 500 lb. weight capacity
- Galvanized steel base, 18 gauge, powder coated



4070 Power Exam Table

- Seamless upholstery with antimicrobial guard
- ADA compliant 19" low access seat height
- 600 lb. patient weight capacity
- Power hi-lo, and manual back with gas spring assist
- 1 function foot control
- Painted steel leg pullout and removable upholstered leg cushion
- Leg section elevates 10° for patient comfort
- Front storage drawer and removable stainless steel drain pan (3.5qt./3.3 L) and one touch, easy-glide stirrups
- Concealed paper roll holder (18"-21")
- Electromechanical actuator system
- Available in a variety of colors



Clinical Recliners

Standard Care Cliner



- Standard trendelenberg release on back with easy-access handle
- Wide elastic bands on back frame & seat provide enhanced comfort and support
- Non-porous, fold-down side tray contains small spills (standard on right & left sides)
- Recessed hand-grips in entering and exiting chair
- Total-lock and directional-lock casters for easy maneuverability
- Removable side panels for easy cleaning and maintenance
- Optional accessories: heat or heat and massage, IV pole (left rear only), leg extensions, side cushion

Extra Large Care Cliner



- Standard trendelenberg release on back with easy-access handle
- Wide elastic bands on back frame & seat provide enhanced comfort and support
- Non-porous, fold-down side tray contains small spills (standard on right & left sides)
- Recessed hand-grips in entering and exiting chair
- Total-lock and directional-lock casters for easy maneuverability
- Removable side panels for easy cleaning and maintenance
- Optional accessories: heat or heat and massage, IV pole (left rear only), leg extensions, side cushion

Overbed Tables

Epoxy-Painted Base Overbed Table

- Tabletop dimensions: 32"L x 15.5"W
- Height adjustment: 29" - 46.5"
- Weight capacity: 40 lbs.
- Easily repositions at the touch of a button
- Constructed of reinforced cast aluminum
- Thick bull nosed edging protects walls/surface
- Available in 7 finishes (standard is solar oak)
- U-shaped base
- Dual 2" casters
- 1 year warranty



Available Finishes:



Kensington Maple



Monticello Maple

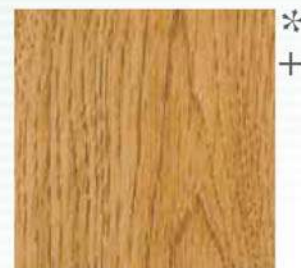

Solar Oak



Amber Cherry

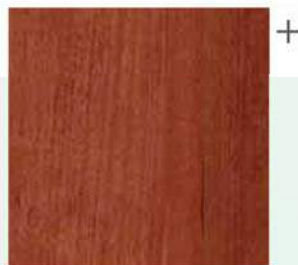

Biltmore Cherry



African Walnut



Montana Walnut

***Camden finishes**
+ Hamilton finishes

Medical Seating

973 Exam Stool: D-Handle Release

Standard Features:

- Polished aluminum base
- Standard height adjustment: 17" – 22"
- Seat diameter: 16"
- Base diameter 24"
- California 117 fire resistant foam
- 3/4" thick composite substrate with steel reinforcement plate
- Weight capacity: 300 lbs.
- COM requirement 1 yd

Options:

- Back rest (Order ex. IN973-B)
- 18" polished chrome foot rest (Order ex. IN973-F)
- 7" stroke cylinder: 19" - 26" (Order ex. IN973-7)
- 10" stroke cylinder: 23" - 33" (Order ex. 973-10)
- Procedure arm (Order ex. 973-PA)
- Soft wheel casters or glides (Please specify)



IN973

873 Lab Stool: D-Handle

Standard Features:

- Polished aluminum base
- Seat height adjustment: 23" to 33"
- Seat diameter: 15 3/4"
- Base diameter: 24"
- California 117 fire resistant
- 3/4" thick composite substrate with steel reinforcement plate
- Adjustable seat back
- Seat back dimensions: 15 3/4" x 9 1/2"
- 18" diameter foot rest
- Standard with casters
- Weight capacity: 300 lbs.
- COM requirement 1 yd

Options:

- 7" stroke cylinder 19" - 26" (Order ex. IN873-7)
- Soft wheel casters or glides (Please specify)



IN873



Storage/Organization

Catheter Procedure Carts:

- QuadTruss® design makes shelves up to 25% stronger and provides a retaining ledge for increased storage stability and product retention
- Combination of hooks, shelves, and tote boxes give the versatility to hold all sizes and styles of catheter packages
- Adjustable components, shelves are vertically adjustable on 1" increments
- Hooks, shelf dividers, and tote boxes allow for easy organization
- Label holders provided to help in organization of inventory
- 5" diameter swivel casters with polyurethane tread, 2 with brakes



Stem Caster Carts:

- Open-wire construction to reduce dust build-up
- Variety of 5" x 1 1/4" casters available
- Four 63" posts
- Four shelves
- Plastic split sleeves
- Donut bumpers
- 68" overall height
- Fast assembly without tools
- Available in many different sizes



Storage/Organization

Cart Accessories:

Cart Covers:

- Lightweight cart cover
- Easy to handle
- Top corners are reinforced
- Choice of white coated, white uncoated, or transparent vinyl
- Coated cart covers available in blue and light green
- Choice of zipper or Velcro
- Double-flap option available



EACZC-54-1848

Storage Bins:

- Capable of being stacked, nested, and divided
- Storage bins help create an efficient storage and inventory system for a vast array of healthcare items
- Easily accessible and allows visual contact with items being stored
- Made of durable long-lasting polypropylene for years of usage



(Supply bins)



(Bulk supply tub)



(Exchange bins)

High Capacity Column Scale

- Wireless transmission, RS232 compatible
- Capacity: 660 lbs. / 300 kg./ 47 sts
- Graduation: 0.1 lbs. < 330 lbs. > 0.2 lbs. / 50 g < 150 kg. > 100 g / 0.1 lbs. < 23 sts > 0.2 lbs.
- Functions: TARE, pre-TARE, HOLD, BMI, mother/child-function, auto-HOLD, auto-CLEAR, lbs/kg switch over, damping, automatic switch-off, SEND/PRINT
- Measuring rod included
- Optional: telescopic measuring rod, power adapter, switch-mode, power adapter



Digital Column Scale

- BMI function
- Capacity: 450 lbs. / 200 kg
- Graduation: 0.2 lbs. / 100 g
- Functions: TARE, HOLD, BMI, lbs/kg switch-over, automatic switch-off
- Measuring rod included
- Optional: telescopic measuring rod, power adapter, switch-mode power adapter



Mechanical Column Scale

- Eye-level beam
- Capacity: 500 lbs. / 220 kg or 400 lbs. / 160 kg
- Graduation: 1/8 lb. / 50 g
- Functions: reset-to-zero function
- Measuring rod included



Patient Handling

**Reduces
Chance of Cross-
Contamination**

Slip-Resistant

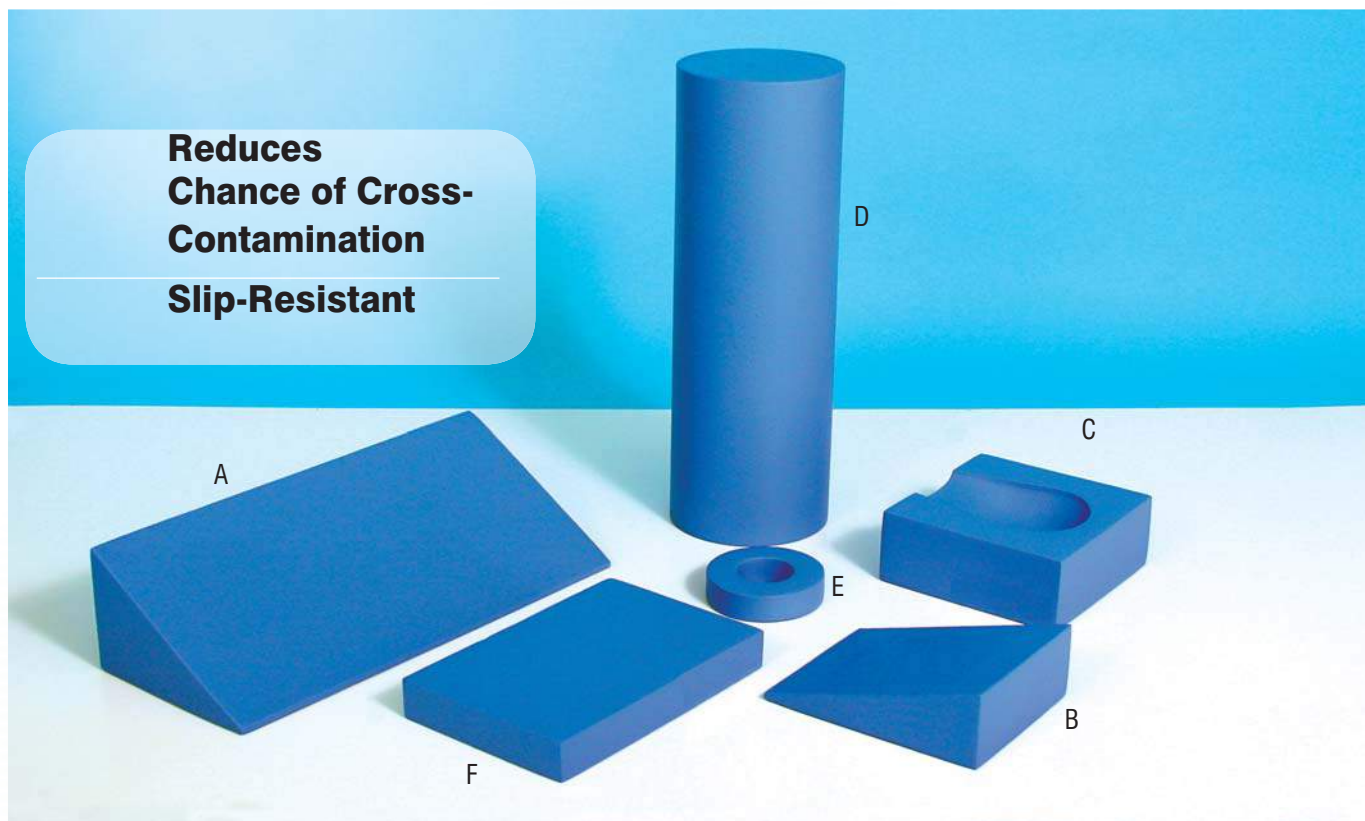

Coated Positioning Pads

Reusable antimicrobial coated positioners ideal for extremity positioning. The positioners are radiolucent and the coating is impregnated with Agion antimicrobial ionic silver that inhibits the growth of bacteria.

Item #	Description	Dimensions
A. FACC508-0355	Double Angle Wedge, 35°/55°	24"L x 9 ³ / ₄ "W x 6 ³ / ₄ "H (61cm x 25cm x 17cm)
FACC508-0356	Angle Wedge, 45°	24"L x 7"W x 7"H (61cm x 18cm x 18cm)
FACC508-0357	Wedge, 15°	10 ¹ / ₂ "L x 9 ³ / ₄ "W x 2 ³ / ₄ "H (27cm x 25cm x 7cm)
B. FACC508-0358	Double Angle, 55°/35°	14"L x 9 ¹ / ₂ "W x 6 ¹ / ₂ "H (36cm x 24cm x 17cm)
FACC508-0359	Wedge, 20°	11"L x 8 ¹ / ₂ "W x 3 ³ / ₄ "H (28cm x 22cm x 10cm)
FACC508-0360	Head & Neck	10 ³ / ₄ "L x 7"W x 6"H (27cm x 18cm x 15cm)
C. FACC508-0361	Head Support, Occipital Adult	10"L x 10"W x 4"H (25cm x 25cm x 10cm)
D. FACC508-0364	Semicircle	14"L x 8 ¹ / ₂ "W x 4 ¹ / ₂ "H (36cm x 22cm x 11cm)
FACC508-0365	Rolls, Small	24"L x 6"D (61cm x 15cm)
FACC508-0366	Rolls, Large	24"L x 8"D (61cm x 20cm)
E. FACC508-0367	Donut, Large, 6 pk.	9"D x 1 ¹ / ₂ "H (23cm x 4cm)
FACC508-0368	Donut, Small, 6 pk.	6"D x 1 ¹ / ₂ "H (15cm x 4cm)
F. FACC508-0362	Rectangular, Large	14"L x 9 ¹ / ₄ "W x 2"H (36cm x 24cm x 5cm)
FACC508-0363	Rectangular, Small	9 ¹ / ₂ "L x 7"W x 2"H (24cm x 18cm x 5cm)

Patient Handling

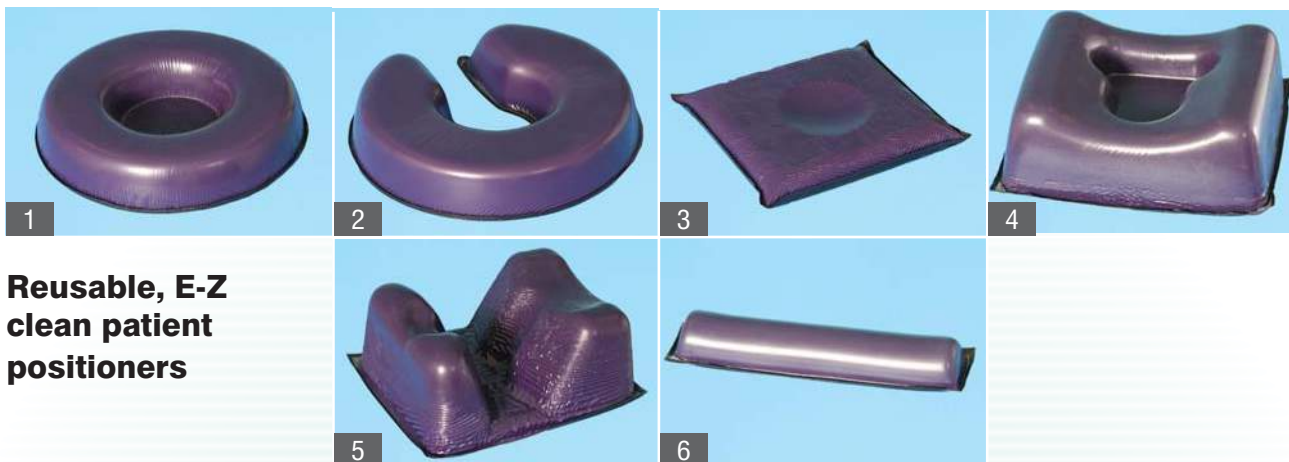

Reusable, E-Z clean patient positioners

Gel Head Positioners

1 Gel Donut

FACC508-0431 Adult
3" I.D x 8" O.D x 2" (8cm x 20cm x 5cm)

FACC508-0432 Tall Adult
3" I.D x 8" O.D x 3" (8cm x 20cm x 8cm)

FACC508-0446 Pediatric
2¹/₄" I.D x 5¹/₂" O.D x 1¹/₄"
(8cm x 20cm x 8cm)

FACC508-0478 Neonatal
1¹/₂" I.D x 3¹/₂" O.D x 3³/₄"
(4cm x 9cm x 2cm)

2 Gel Horseshoe

FACC508-0443 Adult
3" I.D x 8" O.D x 2" (8cm x 20cm x 5cm)

FACC508-0444 Tall Adult
3" I.D x 8" O.D x 3" (8cm x 20cm x 8cm)

FACC508-0447 Pediatric
2¹/₄" I.D x 5¹/₂" O.D x 1¹/₄"
(6cm x 14cm x 3cm)

FACC508-0479 Neonatal
1¹/₂" I.D x 3¹/₂" O.D x 3³/₄"
(4cm x 9cm x 2cm)

3 Gel Head Pad w/Center Dish

FACC508-0470 Lateral
10" x 9" x 1" (25cm x 23cm x 3cm)

FACC508-0473 Supine
10" x 9" x 2" (25cm x 23cm x 5cm)

FACC508-0486 Pediatric Supine
7" x 6" x 2" (18cm x 15cm x 5cm)

FACC508-0487 Pediatric Lateral
7" x 6" x 1" (18cm x 15cm x 3cm)

FACC508-0488 Neonatal Supine
5" x 4" x 2" (13cm x 10cm x 5cm)

FACC508-0489 Neonatal Lateral
5" x 4" x 1" (13cm x 10cm x 3cm)

Gel Head Rest

FACC508-0520 Contoured
7" x 7" x 3¹/₄" (18cm x 18cm x 8cm)

FACC508-0532 Ophthalmic
12" x 10" x 3⁷/₈" (31cm x 25cm x 10cm)

4 Gel Richard Type Headrest

FACC508-0462 T Shape
9" x 8" x 4" (23cm x 20cm x 10cm)

FACC508-0463 Tall T Shape
9" x 8" x 4¹/₂" (23cm x 20cm x 11cm)

5 Gel Prone/Supine Headrest

FACC508-0464 w/Anesthesia Tube Cutouts
11" x 9" x 6" (28cm x 23cm x 15cm)

Chest and Axillary Positioners & Rolls

6 Gel Pediatric Chest Roll Flat Bottom

FACC508-0418 10" x 2" x 2" (25cm x 5cm x 5cm)

FACC508-0419 10" x 3" x 3" (25cm x 8cm x 8cm)

FACC508-0420 4" x 2" x 2" (10cm x 5cm x 5cm)

FACC508-0421 4" x 3" x 3" (10cm x 8cm x 8cm)

FACC508-0422 6" x 2" x 2" (15cm x 5cm x 5cm)

FACC508-0423 6" x 3" x 3" (15cm x 8cm x 8cm)

FACC508-0424 8" x 2" x 2" (20cm x 5cm x 5cm)

FACC508-0425 8" x 3" x 3" (20cm x 8cm x 8cm)

FACC508-0550 12" x 2" x 2" (31cm x 5cm x 5cm)

FACC508-0551 12" x 3" x 3" (31cm x 8cm x 8cm)

Patient Handling

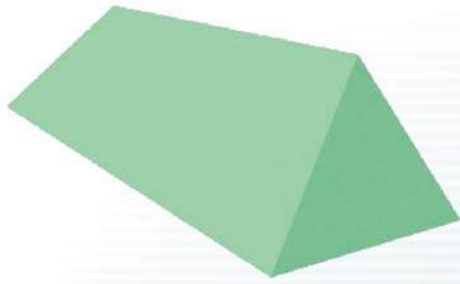

TE-YCEE 45° Echnocardiography Wedge Coated Sponge

Size: 13" x 38.25" x 9"

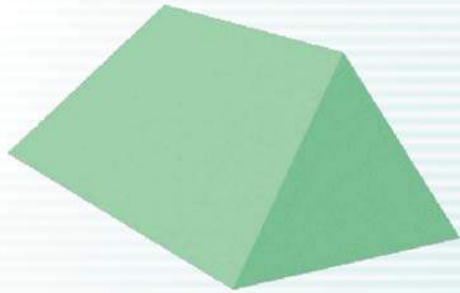

TE-YCBB 45° Spinal Wedge Coated Sponge

Size: 10" x 20.25" x 7"

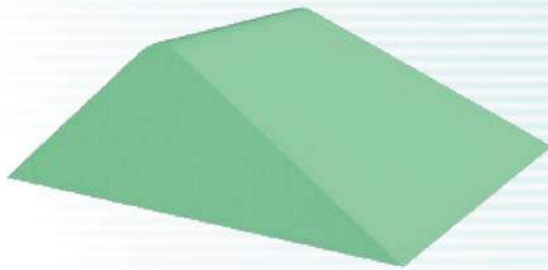

TE-YCAJ Knee Wedge Support Coated Sponge

Size: 22" x 20" x 7"

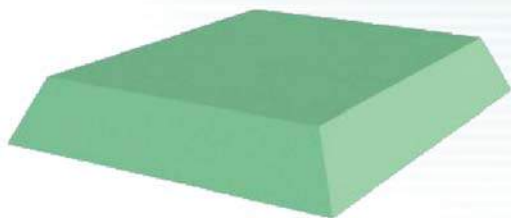

TE-YCBN 3" Rectangle Coated Positioner

Size: 16.5" X 20.5" X 3"

Patient Handling

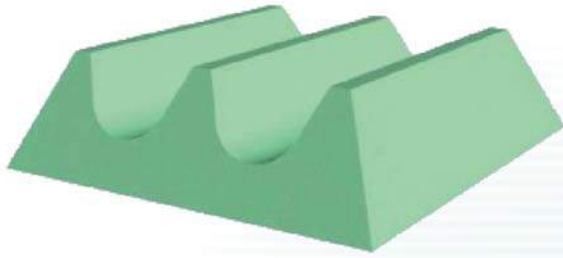

TE-YCAG Bilateral Leg Immobilizer Coated Sponge

Size: 20" x 21" x 6"



C02033767-20 (Coated, Royal Blue)

Size: 9" x 9" x 30"



C02033767-SC (Coated, White)

Size: 9" x 9" x 30"



C0209100 Clear-Vu Arm Support

Size: 11.75" x 12"



To see our full patient positioning line, call us at 800-282-8644.

Diagnostic Equipment

Stethoscopes

We offer stethoscopes for all types of medical specialties including pediatrics, cardiologists, and clinicians, to ensure we fulfill all your diagnostic needs.



Otosscopes/Ophthalmoscopes

Our line of otoscopes offer high quality optics and workmanship with consumer budget in mind.



Diagnostic Equipment

Sphygmomanometers

From clock aneroid sphygs to pocket sphygs we carry all types of sphygmomanometers to give customers the best possible options.



Blood Pressure Cuffs

We have all the essential blood pressure cuffs for your facility with sizes ranging from newborn to adult.

Color Coded Cuff Sizes

NEWBORN	6cm to 11cm
INFANT	10cm to 19cm
CHILD	18cm to 26cm
ADULT	25cm to 35cm
LARGE ARM	33cm to 47cm
THIGH	46cm to 66cm



AB2

Wheelchairs

Traveler SE Series Wheelchair

- Black vinyl upholstery
- Chart pocket on back
- “Tool Free” adjustable front rigging
- Hammer tone paint provides durable finish
- Industry compatible front rigging
- 2-position axle and caster fork for 2” seat height and adjustment
- Maximum weight capacity of 250 lbs. (Evenly distributed)
- Meets Medicare code K0001 and K0002
- Limited 1 year warranty on side frames and cross braces



Traveler HD Series Wheelchair

- Embossed black leatherette upholstery with double inner lining for durability
- Hammer tone paint provides a durable finish
- Reinforced frame at all critical load-bearing points
- “Tool Free” adjustable front rigging
- Chart pocket standard on back upholstery
- 24” x 1” black plastic wheels with black handrims and non-marking polyurethane tires
- Front rigging with heel loops standard on swing-away footrests
- Durable aluminum black footplates
- 2-position axle and caster fork for 2” seat height and adjustment
- Maximum weight capacity of 500 lbs. (Evenly distributed)
- Meets Medicare code K0007
- 5 year warranty on side frames and cross braces



Surgical Instruments

Surgical Scissors

Full line of high quality surgical scissors available for any type of procedure requirement.



Thumb Forceps

Extensive line of thumb forceps available for all facility needs.



Forceps & Clamps

We supply a vast variety of forceps and clamps to meet all of your procedural and surgical demands.



Surgical Instruments

Retractors & Hooks

Multiple retractors and hooks are available for your surgical instrument needs.



Needle Holders

All types of needle holder sizes and shapes are available for multiple scenarios.

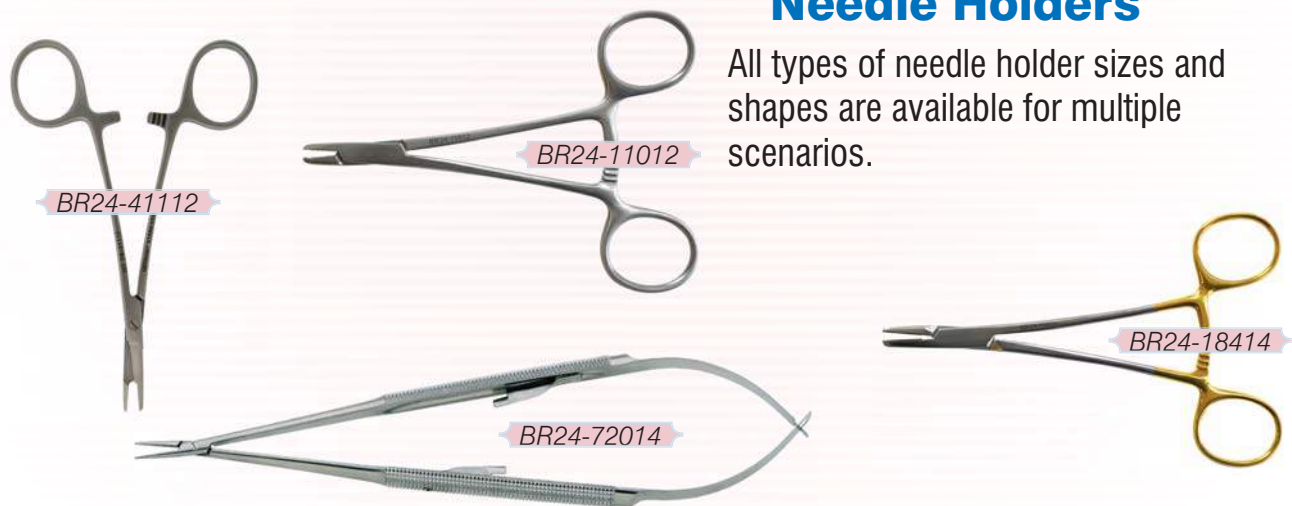

General Instruments

Along with many other surgical instruments, FHC carries products such as: blades, hammers, pin-wheels, and even cast spreaders for your convenience.

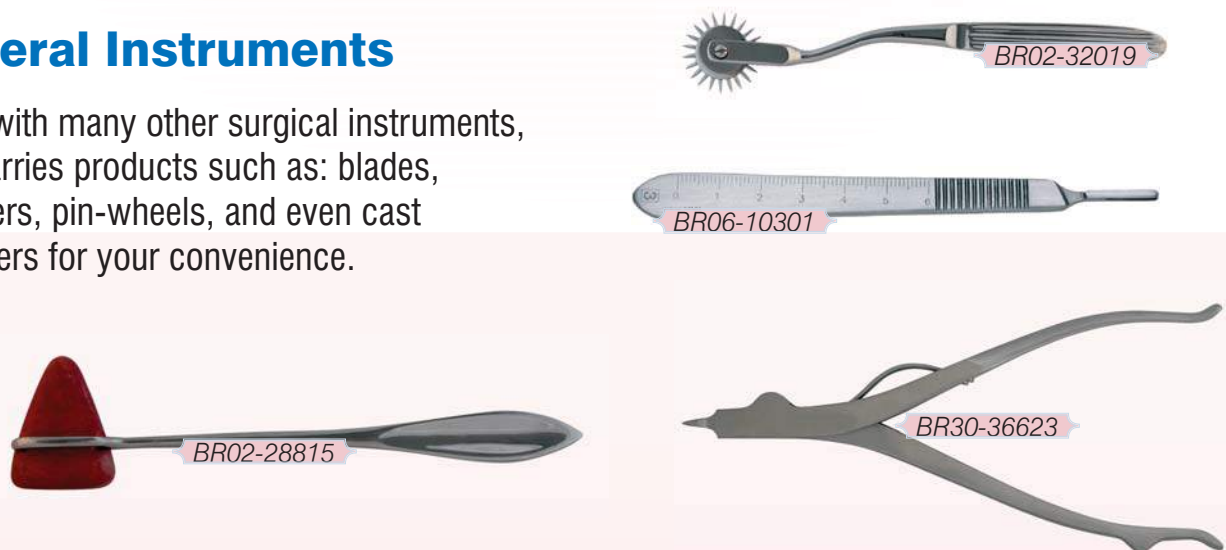

Radiation Accessories

Lead Apron Options:

Any of our lead aprons can be custom fitted for a either for male or female by supplying the following information:

Front Aprons:

- Length (measure from the top of the shoulder, by the neck, straight down over the chest to the length required).
- Chest (measure around the chest at the underarm).

Two Piece Aprons:

- Chest (measure around the chest at the underarm).
- Vest Length (measure from the top of the shoulder over the chest to two inches below the waist).
- Waist.
- Hips (measure the widest part of the hips).
- Skirt Length (measure from the waist down to just above the knee).

Jacket

- Chest (measure around the chest at the underarm).
- Waist.
- Hips (measure around the widest part of the hips).
- Length (measure from the top of the shoulder down over the chest to the length desired).

SIZING CHART

TWO PIECE										
Size	MALE					FEMALE				
	Ht	Chest	Waist	Hips	Length (V/S)	Ht	Chest	Waist	Hips	Length (V/S)
S	5'5"	39"	28"	31"	22/20	5'2"	33"	28"	34"	19/20
M	5'7"	43"	34"	38"	24/20	5'5"	36"	31"	38"	20/23
L	5'11"	45"	39"	44"	25/21	5'8"	43"	34"	41"	22/23
XL	6'2"	50"	42"	46"	26/21	5'10"	46"	37"	44"	22/23

JACKET

Size	MALE					FEMALE				
	Ht	Chest	Waist	Hips	Length	Ht	Chest	Waist	Hips	Length
S	5'5"	40"	30"	40"	36"	5'2"	36"		38"	34"
M	5'7"	43"	37"	43"	38"	5'5"	38"		42"	37"
L	5'10"	45"	42"	46"	40.5"	5'8"	42"		46"	40.5"
XL	5'11"	50"	50"	52"	42.5"	5'10"	46"		50"	42.5"

FRONT APRONS

Size	MALE				FEMALE				
	Ht	Chest	Length	Width	Ht	Chest	Length	Dress	Width
S	5'5"	38"	34"	22.5"	5'2"	34"	34"	6-8	21"
M	5'7"	40-43"	37"	23"	5'5"	36-39"	36"	8-10	22"
L	5'11"	44-46"	40.5"	24"	5'7"	40-44"	38.5"	12-14	24"
XL	6'2"	50-54"	42.5"	26"	5'11"	46-50"	40.5"	16-18	26"

SIZING CHART FOR XXTRA LARGE AND LARGER SIZES
(must use skin over XX size)

Size	SKIRT				VEST		JACKET			FRONT	
	MALE		FEMALE		MALE	FEMALE	MALE	FEMALE		MALE	FEMALE
	Hips	Waist	Hips	Waist	Chest	Chest	Chest	Chest	Hips	Chest	Chest
X	46"	42"	44"	37"	50"	46"	50"	46"	50"	50-54"	46"
XX	50"	46"	48"	41"	54"	50"	54"	50"	54"	54-58"	52"
XXX	54"	50"	52"	44"	58"	54"	58"	54"	58"	58-61"	56"
XXXX	58"	54"	56"		62"	58"	62"	58"		61"+	60"+

Radiation Accessories

Lead Weight Options:

	Lead Distribution		Average Attenuation	Pb. Equiv. at 80 k Vp	Approximate Weight of Front Aprons
	Jacket & Two Piece	Front Aprons			
REGULAR LEAD	.5mm front and .25mm back	.5mm lead equivalent	98.5%	.5mm	9lbs
FEATHERWEIGHT			98.5%	.5mm	8lbs
ULTRA-LITE			98.5%	.5mm	7lbs
EARTH-LITE			98.5%	.5mm	6lbs

REGULAR LEAD:

Our most economical lead which has been reformulated to make it more flexible and to reduce the weight without sacrificing the protection.

FEATHERWEIGHT:

Our Featherweight lead is approximately 15% lighter and more flexible than our regular lead but provides the same protection up to 100kVp.

ULTRA-LITE:

Unless you prefer to sacrifice protection, this is the lightest lead you can buy and still meet the standards of protection. Our Ultra-Lite aprons are approximately 10% lighter than our Featherweight aprons.

EARTH-LITE:

Protection without lead so it is environmentally safe. The Earth-Lite apron is the lightest apron available and meets the standards of protection.

WARRANTY

The manufacturer warrants all LEAD PRODUCTS to be free of defects in workmanship and materials for a period of one year. Seller's obligation is hereby limited exclusively to repair and replacement of any defective products. Seller hereby DISCLAIMS all other warranties, either expressed or implied including any implied warranty of MERCHANTABILITY. There are no warranties which extend beyond the description on the face herein.

DISPOSAL

Any apron manufactured by Pulse Medical will be disposed of by Pulse Medical at no charge for our valuable customers. To dispose any other lead, please contact the original manufacturer.

Radiation Accessories

Full Protection Aprons:



THE TWO PIECE APRON

When full protection becomes important, the **TWO PIECE** should be your choice. Two pieces add to your comfort through more efficient distribution of weight. Each front vest panel is .5mm Pb. equiv. The vest comes with shoulder pads, pocket, and embroidery. The skirt has hanging loops as well as attached belt to tighten the waist. For a smaller waist, we can sew elastic in the back of the skirt.

Part #		Part #
(Male)		(Female)
SMTF	Small	SFTF
MMTF	Medium	MFTF
LMTF	Large	LFTF
XMTF	X-Large	XFTF



THE SLOT STRETCHY BACK APRON

While still getting full protection, the customer also receives our lightest vest. This design incorporates back lumbar support with elastic in the back. The **SLOT STRETCHY BACK**, allows the customer to adjust for maximum comfort. We include shoulder pads, pocket, and embroidery.

Part #
SSBTP
(Specify Size and Gender)

To Order:

Type	Weight	Part #
Regular	9 lbs.	PU-
Featherweight	8 lbs.	PUFW-
Ultra-Lite	7 lbs.	PUUL-
Earth-Lite	6 lbs.	PUEL-

Ex: PUFW-LMTF = Large Male Featherweight Two-Piece Apron

Radiation Accessories

Full Protection Aprons:



THE JACKET APRON

Our **JACKET** apron was designed for optimal protection. Your comfort is also a primary concern so a wide support belt and shoulder pads are standard. Each front panel is .5mm Pb. equiv. An embroidered pocket is also included.

Part # (Male)		Part # (Female)
SMJ	Small	SFJ
MMJ	Medium	MFJ
LMJ	Large	LFJ
XMJ	X-Large	XFJ



THE BACK CLOSE WRAP JACKET

The **BACK CLOSE WRAP** is our lightest full protection jacket. As an improvement, this style has a strap across the shoulders to hold them in place. For a more secure fit, we added front buckles. Shoulder pads and an embroidered pocket are also included.

Part #
BCW
(Specify Size and Gender)

To Order:

Type	Weight	Part #
Regular	9 lbs.	PU-
Featherweight	8 lbs.	PUFW-
Ultra-Lite	7 lbs.	PUUL-
Earth-Lite	6 lbs.	PUEL-

Ex: PU-SFJ = Small Female Regular Jacket Aprons

Radiation Accessories

Full Protection Aprons:



THE MATERNITY JACKET APRON

The front of the **MATERNITY JACKET** apron (.5mm Pb equiv.) is tapered for maximum adjustability as needed. We can include a specially designed half-apron to be worn under the full apron for double protection in the abdomen-pelvic cavity (1.0mm Pb total equivalence). The lead used is the lightest currently available. Also available in front protection only.

Part #

MJMA (Medium: max waist 56")

LJMA (Large: max waist 60")



THE PONCHO APRON

The **PONCHO APRON** is an economical solution to the need for wrap-around protection. The one-sided Velcro closure allows greater flexibility in sizing. Front protection is .5mm Pb and the back is .25mm Pb equivalence. Sizing is unisex.

Part #

SPA (Small)

MPA (Medium)

LPA (Large)

XPA (X-Large)

(MUST SPECIFY GENDER)

To Order:

Type	Weight	Part #
Regular	9 lbs.	PU-
Featherweight	8 lbs.	PUFW-
Ultra-Lite	7 lbs.	PUUL-
Earth-Lite	6 lbs.	PUEL-

Ex: PUUL-LMA = Large Ultra-Lite Maternity Jacket

Radiation Accessories

Front Protection Aprons:

The reinforced straps are made to last and their unique positioning prevents the apron from falling off the shoulders. A belt loop is added to help hold the straps in place. Shoulder pads are standard as well as one embroidered pocket. A Velcro strap across the shoulders for added comfort is optional.

THE TIE APRON



FRONT

Part # (Male)		Part # (Female)
SMT	Small	SFT
MMT	Medium	MFT
LMT	Large	LFT
XMT	X-Large	XFT



BACK

Fluoro done? Get rid of your apron quickly and easily without breaking the sterile field. A shoulder drop-away can be used with our Stretchy Back and Cummerbund aprons. Shoulder pads are standard as well as one embroidered pocket.

THE DROP-AWAY APRON



FRONT

Part # (Male)		Part # (Female)
SMDA	Small	SFDA
MMDA	Medium	MFDA
LMDA	Large	LFDA
XMDA	X-Large	XFDA



BACK

To Order:

Type	Weight	Part #
Regular	9 lbs.	PU-
Featherweight	8 lbs.	PUFW-
Ultra-Lite	7 lbs.	PUUL-
Earth-Lite	6 lbs.	PUEL-

Ex: PUEL-MMT =
Medium Male Earth-Lite Tie Apron

Radiation Accessories

Front Protection Aprons:

Back discomfort is a complaint of the past when you wear our most comfortable apron. The wide belt takes the weight off the shoulders and provides lower back support. The shoulder pads are standard for additional comfort as well as one embroidered pocket. Shoulder drop-away optional.



FRONT

THE CUMMERBUND APRON

Part # (Male)		Part # (Female)
SMC	Small	SFC
MMC	Medium	MFC
LMC	Large	LFC
XMC	X-Large	XFC



BACK

Our unique Velcro design apron with elasticized back panels for additional support and comfort. Shoulder pads are a standard as well as one embroidered pocket. Shoulder drop-away optional. Also available with bucket closure.



FRONT

THE STRETCHY-BACK APRON

Part # (Male)		Part # (Female)
SMBS	Small	SFBS
MMBS	Medium	MFBS
LMBS	Large	LFBS
XMBS	X-Large	XFBS



BACK

To Order:

Type	Weight	Part #
Regular	9 lbs.	PU-
Featherweight	8 lbs.	PUFW-
Ultra-Lite	7 lbs.	PUUL-
Earth-Lite	6 lbs.	PUEL-

Ex: PUFW-SFC =
Small Female Cummberbund Apron

Radiation Accessories

Front Protection Aprons:



FRONT

THE BUCKLE APRON

The quick release buckle apron is user friendly and our large support straps crisscrossing the back allows proper placement of the belt at your waist. The standard built-in shoulder pads add to the comfort and one embroidered pocket is included.

Part #		Part #
(Male)		(Female)
SMB	Small	SFB
MMB	Medium	MFB
LMB	Large	LFB
XMB	X-Large	XFB



BACK



FRONT

THE VELCRO APRON

We have designed unique back straps to help position the apron while giving greater back support. Shoulder pads are included for additional comfort. Embroidered pocket is also included.

Part #		Part #
(Male)		(Female)
SMV	Small	SFV
MMV	Medium	MFV
LMV	Large	LFV
XMV	X-Large	XFV



BACK

To Order:

Type	Weight	Part #
Regular	9 lbs.	PU-
Featherweight	8 lbs.	PUFW-
Ultra-Lite	7 lbs.	PUUL-
Earth-Lite	6 lbs.	PUEL-

Ex: PU-XMV = Extra Large Male Regular Velcro Apron

Radiation Accessories

Front Protection Aprons:



FRONT

THE MATERNITY VELCRO APRON

This is a Velcro apron with a flared front for maximum adjustability as needed. We can include a specially designed half apron to be worn under the Velcro apron for double protection in the abdomen/pelvic cavity (1.00mm Pb equiv. total) The lead used is the lightest currently available. Also available in full protection.

See the Maternity Jacket Apron.

Size	Height	Chest	Length	Part#
Medium	5' 4"	36"	37"	MVMA
Large	5' 4"	40"	39"	LVMA
HA-8	Large Half Apron		30" x 18"	
HA-7	Medium Half Apron		26" x 16"	

To Order:

Type	Weight	Part #
Regular	9 lbs.	PU-
Featherweight	8 lbs.	PUFW-
Ultra-Lite	7 lbs.	PUUL-
Earth-Lite	6 lbs.	PUEL-

Ex: PUFW-LMTP = Large Male Featherweight Two-Piece Apron

FHC Apron Recovery:

We can recover any apron into practically any style and make it look like new. The customer assumes responsibility for checking the apron for holes prior to sending it to us. We will visually examine all lead and patch small up to 2 pin holes marked by the customer. Most aprons will be recovered with shoulder pads, and an embroidered pocket.

Recoveries are either:

- As is: same style, just replacing fabric and binding,
or
- Alteration required: tell us what to change (style or size) and we'll try to make it possible for you.

Apron Style	Part #
Buckle	PURB
Tie	PURT
Velcro	PURV
Cummerbund	PURC
Drop-Away	PURDA
Stretchy-Back	PURSB
Two Piece	PURTP
Jacket	PURJ
Slot Stretchy-Back Two Piece	PURSSBTP
Back Close Wrap	PURBCW

Radiation Accessories

Apron Accessories:

Thyroid Shields



Standard Thyroid

- The only thyroid made with 2" loop velcro and 1" hook, for easier closure.
- The softest, most comfortable thyroid collar made. No binding to irritate the neck.



Ring Attached

- Keep your collar attached to your apron, or detach it with this clever design.

Lap Pad



- Standard size: 18" x 24"
- Protection for any area of the body
- Any custom size available

Gonad Shields

Individual Shields (w/or w/o ties)



Gonad Shield Set

The set includes 2 small, 1 medium, 1 large gonad shields and a belt all with Velcro for an interchangeable system (shown with Gonad Shield & Belt System)

Size	Part#
Small (6 x 4")	PUGS-101
Medium (8 x 6")	PUGS-102
Large (10 x 7")	PUGS-103
Set of Four	PUGS-104

*Add T to part # for ties (PUGS-103T)



Cummerbund Belt

Size	Part#
to 25"	PU-ABXS
to 24-34"	PU-ABS
to 34-40"	PU-ABM
to 36-50"	PU-ABL
to 40-60"	PU-ABX

WOW Belt

- A patented pulley system cinches the belt for superior lumbar support.
- The perfect addition to keep the weight off the shoulders



Size	Part#
25-30"	PU-60122
30-35"	PU-60148
35-40"	PU-60137
40-45"	PU-60155
45-50"	PU-60170

AE10

Radiation Accessories

Apron Racks:

Porta Rack

- Dimensions: 54"H x 35"W x 24"D
- Hangers available at special price
- Almond coated metal
- Holds up to 12 aprons



Mighty Mack

- Rugged mobile rack for ten aprons

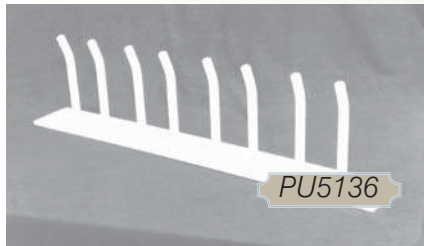

Eight Peg Rack

- Designed to hold four aprons
- Four mounting holds
- High tensile aluminum
- 24" long
- Other sizes available



Five Arm Swing Rack

- Space-saving hanger can fold to right or to left.
- Space required: 28"
- Order PU5137-R for right, PU5138-L for left

Deca Rack

- Designed with the busy OR in mind, the Deca Rack has 10 pivoted arms that fan out to 180°
- It is mounted on locking casters and has a finish of chromium and white.
- Also available with only 5 arms.



Radiation Accessories

Lead Glasses:

BASICS



Crimson
PU53-CWO



Light Brown
PU53-LBWO



Green
PU53-GWO

Weight: 90 Grams
Lead Equiv. Front: .75mmPb
Lead Equiv. Side Shields : .75mmPb
Prescriptions: Single, Bifocal, Progressive



Purple
PU53-PWO



Tortoise
PU53-TWO



Blue
PU53-BLWO

A lightweight fashionable wrap around frame with a built in adjustable nose piece and spring hinges.

CLASSICS



Euro
PU74-S



Astro
PU70-S

80 grams
.75mmPb front
.35mmPb side
All scripts
Adjustable frame



Metallite
Gold
"For Smaller Faces"
PU557S



Metallite
Standard
62 grams
PU662S



Metallite
Bronze
"For Smaller Faces"
PU553S

FITOVERS/GOGGLES



Tortoise
PU89-T

Weight: 92 Grams
Designed to fit over prescription eyewear
Use as a goggle for excellent splash protection
Front and side .75mm Pb equiv
Matte black or Tortoise



Black
PU89-BK

Radiation Accessories

Lead Glasses:

PULSE LITE



Bronze
PUPL-100S-BR



Satin Gray Blue
PUPL-100S-GB



Black
PUPL-100S-BK



Silver
PUPL-100S-S



Crimson
PUPL-100S-CR

Weight: 60 Grams
 Lead Equiv. Front: .75mmPb
 Lead Equiv. Side Shields: .35mmPb
 (optional add "-S" after 100)
 Prescriptions: Single, Bifocal

A lightweight fashionable wrap around frame with anti reflective coating. Available with lead sheeting as a side shield placed on the inside between the end of the lense and the ear piece.

PULSE LITE "MAXI"



Crimson Maxi
PUMAX-100-R



Black Maxi
PUMAX-100-BK



Silver Maxi
Shown with ultra soft fixed rubber nose piece
PUMAX-100-S



Silver Maxi
PUMAX-100-S



Blue Maxi
PUMAX-100-BL

Weight: 63 grams
 Lead Equiv. Front: .75mmPb
 Lead Equiv. Side Shields: .35mmPb
 (optional add "-S" after 100)
 Prescriptions: Single, Bifocal, Progressive
 Size: Slightly smaller than Pulse Lites
 Other: Ultra soft fixed rubber nose piece

ICICLE



Blue
PIC-100-B



Orange
PIC-100-O

Weight : 65 grams
 Lead Equiv. Front: .75 mmPb
 Lead Equiv. Side Shield: .35mmPb
 (optional add "-S" after 100)
 Prescriptions: Single, Bifocal

A beautiful Italian manufactured curved lense nylon frame. The optional lead sheeting side shields are placed on the inside between the end of the lense and the ear piece.

Radiation Accessories

Lead Glasses:



Silver

PUPD-100S-S

PREDATOR

- Front Lens: .75mmpb
- Side Shield: 50mm Pb
- No Script



Black

PUPD-100S-BK



Black

PUNL-100S-BK

NEON-LITES

- Front Lens: .75mmpb
- Side Shield: 50mm Pb
- Available w/o side shields
- No Script



Green

PUNL-100S-GR



Orange

PUNL-100S-OR



Blue

PUNL-100S-BL



Purple

PUNL-100S-PU

CRUISER FLEX

- .75mmpb front
- Plano only
- Optional side shields
- No scripts
- Black/yellow color only



PUCD-100



The Pathfinder

PUPF-100-DT



The Delta Force

PUDF-100-T



The Sniper

PUSN-100-W

SPECIAL OPS

- .75mmpb front lens
- A donation will be made to the SEAL LEGACY FOUNDATION in support of fallen & wounded US NAVY SEALs & their Families
- Colors and specifications may vary



The Pararescue

PUPA-100-SD



The Recon

PURE-100-R



The Seal

PUSE-100-R



The Ranger

PURAN-100-BK



The Green Beret

PUGB-100-W

AE14

Radiation Accessories

Radiation Gloves:



Lead Gloves

- Flexible vinyl cover
- .5mm Pb protection
- 15" length



Scatter-Reducing Gloves

- **PURR1** (+ size) Attenuates 45% at 60kVp
- **PURR2** (+ size) Attenuates 55% at 60kVp



Radiation Attenuating Surgical Gloves

- Reduced exposure to harmful rays
- Thin gloves of only .0009" thick for optimal flexibility, dexterity and sensitivity
- 100% tested for pin holes and leaks
- Gloves available in half sizes from 6.5 to 9
- Applicable with Fluoroscopy, Orthopedics, Radioisotope Handling, Cardiology, Radiology, Dental, and Nuclear Medicine

Performance:

Source Potential	R-1
60kVp	45%
80kVp	35%
100kVp	26%
120kVp	23%

Radiation Accessories

Techline 200 Series X-Ray Illuminators

- Two F15IT8/D lamps (per panel)
- Instant-on ballasts
- Electronic
- Centralized cluster switching
- UL 60601 and cUL Certified
- Roller gravity film-holding system
- Thin 3" profile
- Durable steel construction
- Continuous bottom film ledge
- Chip resistant hospital white finish
- Even Vue reflective system
- Includes hospital grade plug
- Overall Dimensions 14"L x 21"H x 3 3/8"D
- Illumination: 2000 cd/m²
- Available in surface and recess configurations from 1 panel up to 6 over 6.
- Optional: film activated switching, master switch (standard on recessed units), mobile stand



MATS202

Techline 300 Series X-Ray Illuminators

- Three F15IT8/D lamps (per panel)
- Instant-on ballasts
- Electronic
- Centralized cluster switching
- UL 60601 and cUL Certified
- Roller gravity film-holding system
- Thin 3" profile
- Durable steel construction
- Continuous bottom film ledge
- Chip resistant hospital white finish
- Even Vue reflective system
- Includes hospital grade plug
- Overall Dimensions 14"L x 21"H x 3 3/8"D
- Illumination: 3000 cd/m²
- Available in surface and recess configurations from 1 panel up to 6 over 6.
- Optional: film activated switching, master switch (standard on recessed units), mobile stand



MATS302

Replacement Parts

Door Gaskets:

Item #	Item Description
FHCW0020	Door Gasket FHC Bottom FHCDWC24 S/S Warming Cabinet
FHCW0078	Door Gasket FHC Bottom FHCDWC60 S/S Warming Cabinet
FHCW0019	Door Gasket FHC Top FHCDWC24 S/S Warming Cabinet
FHCW0205	Door Gasket FHC W/C SWC24-G DWC24-G Upper (Glass Door)
FHCW0212	Door Gasket FHC Warming Cabinet FHCSWC1824 (Glass Door)
FHCW0082	Door Gasket FHC Warming Cabinet FHCSWC1824 (S/S Door)
FHCW0080	Door Gasket FHC Warming Cabinet FHCSWC36 (S/S Door)
FHCW0109	Door Gasket FHC Warming Cabinet FHCSWC36-G (Glass Door)
FHCW0081	Door Gasket FHC Warming Cabinet FHCSWC72 (S/S Door)
FHCW0192	Door Gasket FHC Warming Cabinet FHCSWC72-G (Glass Door)
FHCW0206	Door Gasket FHC Warming Lower Cabinet FHCDWC24-G (Glass Door)
TU02610020	Door Gasket Tuttnauer 1730MK
TU02610118	Door Gasket Tuttnauer 2340E/EK, 2340M/MK
TU02610023	Door Gasket Tuttnauer 2540E, 2540EK, 2540M, 2540MK, EZ10K

Air Filters:

Item #	Item Description
TU03140036	Tuttnauer Air Filter 2340 2540 Ez10K E/EK/EKA

Repair Services:

**Celebrating Over 40
Years of Loyal Service.**



Don't forget Future Health Concepts, Inc. also has specially trained, and qualified service technicians to perform maintenance on the majority of your medical equipment at an affordable price!

AF 1

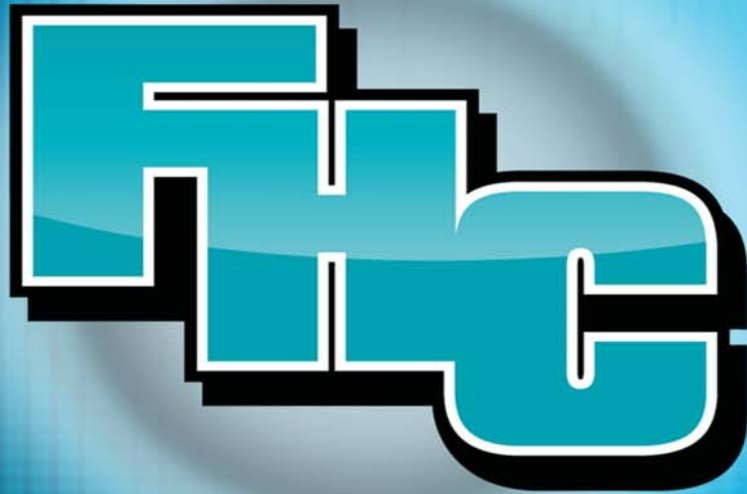

Future Health Concepts, Inc.

Visit our webpage: www.fhcusa.com

**1211 E. 30th Street
Sanford, FL 32773**

**Call Us: 800-282-8644
Fax Us: 407-322-3871
Email: sales@fhcusa.com**