



Future Health Concepts

- Sterilizers
- Anesthesia Machines
- Patient Monitors
- Surgical Scrub Sinks
- Case Carts
- Nurses Documentation Stations
- Surgical Tables
- Blanket & Fluid Warming Cabinets
- Stretchers



Product Catalog

Visit www.fhcusa.com or call us toll free at 800.282.8644



About Us

Dear Customer,

I'd like to take this opportunity to thank you for considering Future Health Concepts, Inc. (FHC) in purchasing of your new, refurbished, and used medical equipment for your facility.

There are several key differences between FHC and the other companies selling used or refurbished medical equipment. Our company is an FDA registered refurbisher and does all of our own medical equipment refurbishing in-house. Our staff has the expertise to work with clients from the planning stage of new facilities or in equipping existing facilities and hospitals. We've completed turn-key operations for both hospital and ambulatory surgical centers since 1975. Our employees are well-trained and follow all GMP standards to assure our clients receive the best new and refurbished medical equipment you can buy.

The primary products refurbished by FHC are Sterilizers, Washers/Disinfectors, and Operating Room Tables. Other quality refurbished medical products are Anesthesia Machines, Patient Monitors, Defibrillators, ESU, and Rigid & Flexible Video Systems along with many other products.

We sell over 70 different lines of new medical equipment and office furniture to complete your needs for your facility.

Our primary new medical products include Blanket/Fluid Warming Cabinets, Operating Room Tables, Scrub Sinks, Patient Monitors, Stretchers, an entire line of Stainless Steel Products, Operating Room Lights, Electrosurgical Units, Defibrillators, a full line of Operating Room Accessories, Medical Carts & Cart Accessories, X-Ray supplies, Steam Generators, Medical Gas Systems and Ultra Sonic Cleaners to list a few.

FHC has a one year parts and labor warranty on all of our refurbished equipment. All new equipment carries a one to five year parts and a one year labor warranty depending on the item.

With a facility over 25,000 sq. ft., we are able to receive and store your equipment at no charge until your specific delivery date. At that time, FHC will ship, install & in-service your staff on all of the new or refurbished medical equipment purchased from us.

Since 1975, FHC has built its business mostly through equipment planners & referrals. We now are contracted supplier's with three of the largest GPO's; Novation, MedAssets and Amerinet. Our client's satisfaction is of the utmost importance to us. We will work to try to exceed your expectations when it comes to equipment needs to develop a long-term relationship with your facility.

Our staff and I look forward to working with you.

Sincerely,
Greg Karleskint
CEO/President



Revision: 1

Table of Contents

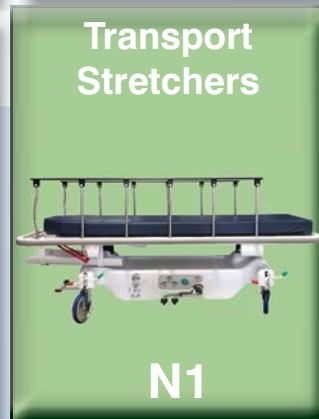
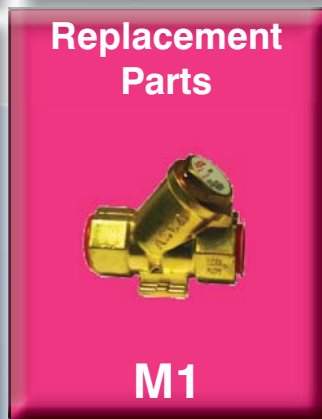
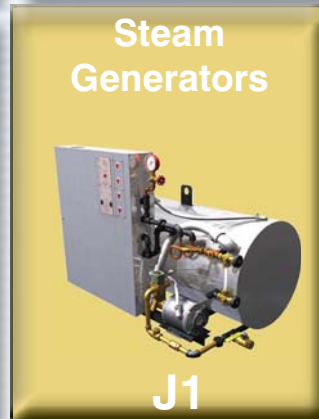
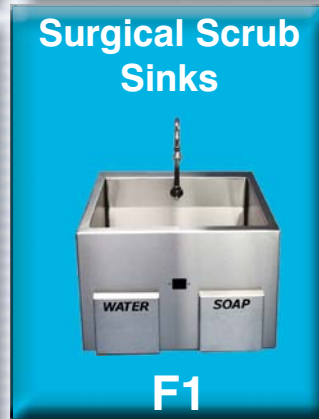
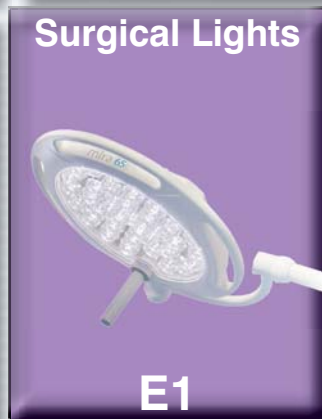
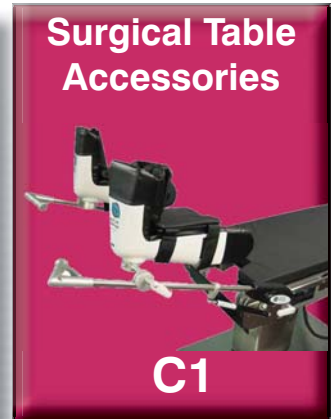
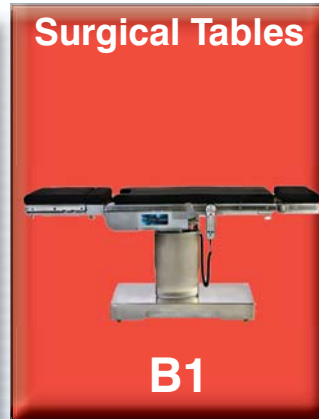
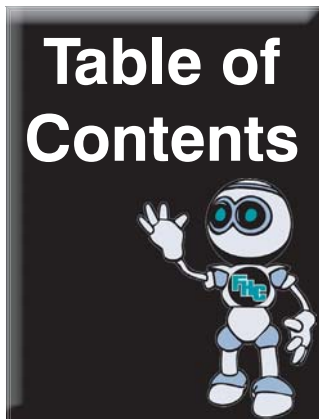

Table of Contents

Anesthesia Machine Parts



P1

Defibrillators



Q1

Patient Monitors



R1

Monitor Accessories



S1

Stainless Steel Cabinetry



T1

Storage & Organization



U1

Surgical Case Carts



V1

Medical Carts



W1

Medical Cart Accessories

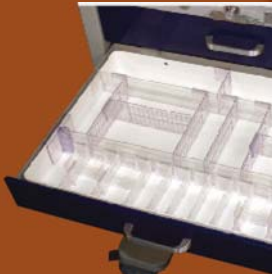

X1

Endoscopy Equipment



Y1

Electrosurgical Units



Z1

Footstools



AA1

Stainless Steel Tables



AB1

IV Stands



AC1

Solution Stands



AD1

Linen Hampers



AE1

Table of Contents

Mayo Stands



AF1

Kick Buckets



AG1

S/S Lab Surgical Products



AH1

Medical Seating



AI1

Clinical Recliners



AJ1

EKG/ECG Machines



AK1

Overbed Tables



AL1

Exam Tables & Chairs



AM1

Diagnostic Equipment



AN1

Scales



AO1

Surgical Instruments



AP1

Wheelchairs



AQ1

Radiation Accessories



AR1

Medical Gas Systems



AS1

Blanket & Fluid Warmers

We offer a large variety of features and options for your convenience!

Future Health Concepts, Inc. offers a variety of Blanket and Fluid Warming Cabinets in both standard and custom sizes to meet individual requirements. As with all of our products, warming cabinets undergo stringent testing procedures during the manufacturing process to assure a long life, the highest quality and accurate temperature settings. We offer standard sizes along with custom sizes to meet specific requirements.

Standard Features:

- Stainless steel or glass door
- Data logging of real time & temp w/ USB retrieval
- Keyed temperature lock out
- Push button digital operation
- Large dual digital displays
- Displays actual temperature and set point at all times
- Separate digitally controlled heating chambers
- Rapid warm time (2-6 hours depending on load)
- Uniform heating
- Fully insulated
- Audible & visual over-temp alarm
- UL/CUL approved
- FDA registered
- OSHPD pre-approved



Standard keyed temperature lockout



Optional door lock

Options:

- Mobile base or cart
- 18" depth
- Full recess
- Pass through chamber
- Left hand door hinge
- Keyed door lock
- Seismic brackets
- 220/240 V, 50/60HZ
- Custom sizes
- Solution baskets
- Touch-screen



FHCSWC1824-B-G

(Shown w/ optional s/s solution baskets)

Blanket & Fluid Warmers

All blanket warmers can be customized to fit your specifications!

NEW!

The Industry's First Touch Screen Warmers



FHCDWC-TS-36G

(Shown w/ optional mobile base)



Alarm notifications via email and text messaging

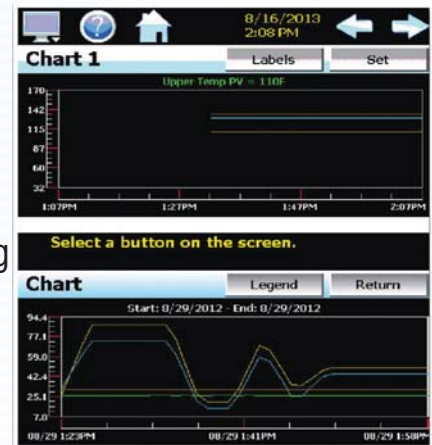

Temperature trending in chart format



Smart phone app

Data recorded in CSV format

#	A	B	C	D	E	F
1	Date	Time		Device Manager	Upper Temp	Lower Temp
2	8/29/2012	13:23:52			90	85
3	8/29/2012	13:24:52			92	85
4	8/29/2012	13:25:52			95	85
5	8/29/2012	13:26:52			102	85
6	8/29/2012	13:27:52			106	87
7	8/29/2012	13:28:52			109	90
8	8/29/2012	13:29:52			110	92
9	8/29/2012	13:30:52			111	95
10	8/29/2012	13:31:52			110	99
11	8/29/2012	13:32:52			110	102
12	8/29/2012	13:33:52			110	105
13	8/29/2012	13:34:52			110	109
14	8/29/2012	13:35:52			110	115
15	8/29/2012	13:36:52			110	118
16	8/29/2012	13:37:52			110	122
17	8/29/2012	13:38:52			110	125
18	8/29/2012	13:39:52			110	127
19	8/29/2012	13:40:52			110	129
20	8/29/2012	13:41:52			110	132
21	8/29/2012	13:42:52			110	134
22	8/29/2012	13:43:52			110	135
23	8/29/2012	13:44:52			110	136
24	8/29/2012	13:45:52			110	135
25	8/29/2012	13:46:52			110	135
26	8/29/2012	13:47:52			110	135
27	8/29/2012	13:48:52			110	135
28	8/29/2012	13:49:52			110	135
29	8/29/2012	13:50:52			110	135

Blanket & Fluid Warmers

FHC is pleased to announce the arrival of our Smart Warmers, the most technologically advanced warmer on the market today!

Featuring embedded data logging, alarm monitoring and LAN features with simple plug and play data downloading that requires no additional software.

Standard Features:

- Touch-screen control
- Built-in Ethernet & Wi-fi ready
- Ease of use with help screens
- Remote monitoring & control (VNC)
- Data logging with digital signatures
- Remote tech support
- View live trends
- Text & email alarm notifications
- Alarm log
- File Transfer via USB or FTP
- Multi-level user security
- Operator audit trail
- Access from smart phone/devices
- Multi-language support (menu & help)
- Stainless steel or glass door
- Data logging of real time & temp w/ USB retrieval
- Temperature lock out
- Push button digital operation
- Large digital displays
- Displays actual temp & set points at all times
- Separate digitally controlled heating chambers
- Rapid warm time (approx. 2-6 hrs)
- Uniform heating
- Fully insulated
- Audible & visual over-temp alarm
- UL/CUL approved
- FDA registered
- OSHPD pre-approved

Options:

- Mobile base or cart
- 18" depth
- Full recess
- Pass through chamber
- Left hand door hinge
- Keyed door lock
- Seismic brackets
- 220/240 V, 50/60HZ
- Custom sizes
- Solution baskets



FHCSWC-TS-24

Blanket & Fluid Warmers



(FHCSWC1518-G-TL shown above)

FHCSWC1518

Overall Size: 18" W x 15.5" D x 22" H

Chamber I.D.

14" W x 13" D x 13" T

1.4 cubic feet of storage

Temperature range: 90-135°F

Accuracy +/- 1°F of set point

Electrical

120v, 3.5 amp., 50/60Hz

.39 kw/hr, 1332 btu/hr

UL/CUL listed

FDA registered



(FHCSWC1824-G shown above)

FHCSWC1824

Overall Size: 24" W x 20.5" D x 24.5" H

Chamber I.D.

20" W x 17" D x 15.25" H

3.0 cubic feet of storage

Temperature range: 90-160°F

Accuracy +/- 1°F of set point

Electrical

120v, 3.5 amp., 50/60Hz

.45 kw/hr, 1537 btu/hr

UL/CUL listed

FDA registered



(FHCSWC24-G shown above)

FHCSWC24

Overall Size: 30" W x 26.5" D x 24.5" H

Chamber I.D.

26" W x 23" D x 15.25" H

5.27 cubic feet of storage

Temperature range: 90-160°F

Accuracy +/- 1°F of set point

1 adjustable shelf

Electrical

120v, 7.5 amp., 50/60Hz

.30 kw/hr, 1024 btu/hr

UL/CUL listed

FDA registered

Blanket & Fluid Warmers

BLANKET & FLUID WARMERS



(FHCSWC36-G shown above)

FHCSWC36

Overall Size: 30" W x 26.5" D x 36" H

Chamber I.D.

26" W x 23" D x 25" H
8.63 cubic feet of storage
Temperature range: 90-160°F
Accuracy +/- 1°F of set point
2 adjustable shelves

Electrical

120v, 7.5 amp., 50/60Hz
.30 kw/hr, 1024 btu/hr
UL/CUL listed
FDA registered

FHC S/S Roll-out Solution Baskets

FHC-WRB

Our blanket warmer solution baskets are designed to provide users with the best solution warmer organization. With these warmer-safe baskets, users are able to efficiently warm solutions inside the deep pull-out baskets to make solution/fluid warming simple, easy, & organized.

(If ordered w/ warmer add -B to model #)



(FHCSWC1824-B-G shown above)

FHC Optional Mobile Stands

FHCT0007: 26"W x 34"D x 34"H

Recommended for models FHCSWC24 & FHCSWC36

FHCT0023: 26"W x 20"D x 34"H

Recommended for models FHCSWC1518 & FHCSWC1824

(If ordered w/ warmer add -MS to model #)



FHCT0007

FHCT0023

Blanket & Fluid Warmers



(FHCSWC2460-G shown above w/ optional mobile base)

FHCSWC2460

Overall Size:

24" W x 20.5" D x 64.75" H
3 adjustable shelves

Chamber I.D.

20" W x 17" D x 49.5" H
13.05 cubic feet of storage
Temperature range: 90-160°F
Accuracy +/- 3°F of set point

Electrical

120v, 7.5 amp., 50/60Hz
.49 kw/hr, 1678 btu/hr
UL/CUL listed
FDA registered



(FHCSWC60-G shown above w/ optional mobile base)

FHCSWC60

Overall Size:

30" W x 20.5" D x 64.5" H
3 adjustable shelves

Chamber I.D.

26" W x 17" D x 51" H
13.05 cubic feet of storage
Temperature range: 90-160°F
Accuracy +/- 3°F of set point

Electrical

120v, 7.5 amp., 50/60Hz
.46 kw/hr, 1570 btu/hr
UL/CUL listed
FDA registered

Blanket & Fluid Warmers

BLANKET & FLUID WARMERS



(FHCSWC72-G shown above w/ optional mobile base)

FHCSWC72

Overall Size:

30" W x 26.5" D x 74.5" H
2 adjustable shelves
2 fixed shelves

Chamber I.D.

26" W x 23" D x 61" H
21 cubic feet of storage
Temperature range: 90-160°F
Accuracy +/- 3°F of set point

Electrical

120v, 7.5 amp., 50/60Hz
.53 kw/hr, 1810 btu/hr
UL/CUL listed
FDA registered



(FHCDWC2424 shown above w/ optional mobile base)

FHCDWC2424

Overall Size:

24" W x 26.5" D x 74.5" H
15.95 cubic feet of storage
3 adjustable shelves

Upper Chamber I.D.

20" W x 23" D x 15.25" H
4.05 cubic feet of storage
Temperature range: 90-160°F
Accuracy +/- 1°F of set point

Lower Chamber I.D.

26" W x 23" D x 34.5" H
11.9 cubic feet of storage
Temperature range: 90-160°F
Accuracy +/- 3°F of set point

Electrical

120v, 10 amp., 50/60Hz
.46 kw/hr, 1570 btu/hr
UL/CUL listed
FDA registered

Blanket & Fluid Warmers



(FHCDWC2460-G shown above)

FHCDWC2460

Overall Size:

24" W x 20.5" D x 64.75" H
7.45 cubic feet of storage
3 adjustable shelves

Upper Chamber I.D.

20" W x 17" D x 13.5" H
2.65 cubic feet of storage
Temperature range: 90-160°F
Accuracy +/- 1°F of set point

Lower Chamber I.D.

20" W x 17" D x 24.5" H
4.80 cubic feet of storage
Temperature range: 90-160°F
Accuracy +/- 2°F of set point

Electrical

120v, 10 amp., 50/60Hz
.49 kw/hr, 1678 btu/hr
UL/CUL listed
FDA registered



(FHCDWC24 shown above w/ optional mobile base)

FHCDWC24

Overall Size:

30" W x 26.5" D x 74.5" H
17.2 cubic feet of storage
3 adjustable shelves

Upper Chamber I.D.

26" W x 23" D x 15.25" H
5.27 cubic feet of storage
Temperature range: 90-160°F
Accuracy +/- 1°F of set point

Lower Chamber I.D.

26" W x 23" D x 34.5" H
11.93 cubic feet of storage
Temperature range: 90-160°F
Accuracy +/- 3°F of set point

Electrical

120v, 12 amp., 50/60Hz
.75 kw/hr, 2557 btu/hr
UL/CUL listed
FDA registered

Blanket & Fluid Warmers



(FHCDWC36-G shown above w/ optional mobile base)

FHCDWC36

Overall Size:

30" W x 26.5" D x 74.5" H
17.59 cubic feet of storage
4 adjustable shelves

Upper Chamber I.D.

26" W x 23" D x 25" H
8.63 cubic feet of storage
Temperature range: 90-160°F
Accuracy +/- 2°F of set point

Lower Chamber I.D.

26" W x 23" D x 26" H
8.96 cubic feet of storage
Temperature range: 90-160°F
Accuracy +/- 2°F of set point

Electrical

120v, 12 amp., 50/60Hz
.69 kw/hr, 2356 btu/hr
UL/CUL listed
FDA registered



(FHCDWC60-G shown above)

FHCDWC60

Overall Size:

30" W x 20.5" D x 64.75" H
9.73 cubic feet of storage
3 adjustable shelves

Upper Chamber I.D.

26" W x 17" D x 13.5" H
3.46 cubic feet of storage
Temperature range: 90-160°F
Accuracy +/- 3°F of set point

Lower Chamber I.D.

26" W x 17" D x 24.5" H
6.27 cubic feet of storage
Temperature range: 90-160°F
Accuracy +/- 3°F of set point

Electrical

120v, 7.5 amp., 50/60Hz
.49 kw/hr, 1678 btu/hr
UL/CUL listed
FDA registered

Blanket & Fluid Warmers



(FHCTWC24-G shown above w/ optional mobile base)

FHCTWC24

Overall Size:

30" W x 26.5" D x 78.25" H
14.00 cubic feet of storage
1 adjustable shelf

Electrical

120v, 13.5 amp., 50/60Hz
.65 kw/hr, 2238 btu/hr
UL/CUL listed
FDA registered

Upper Chamber I.D.

26" W x 23" D x 11.25" H
3.9 cubic feet of storage
Temperature range: 90-110°F
Accuracy +/- 1°F of set point

Middle Chamber I.D.

26" W x 23" D x 10.75" H
3.7 cubic feet of storage
Temperature range: 90-135°F
Accuracy +/- 1°F of set point

Lower Chamber I.D.

26" W x 23" D x 18.50" H
6.4 cubic feet of storage
Temperature range: 90-160°F
Accuracy +/- 1°F of set point

Optional FHC Mobile Base:



FHC-MB

Overall Size:

33" W x 28" D x 6.75" H

(If ordered w/ warmer, add -MB to model #)

Note: Mobile base will add 2" to standard blanket warmer height.

Blanket & Fluid Warmers

How to order Blanket & Fluid Warming Cabinets

Options Available	18" Depth	Glass Doors	Mobile Base	Mobile Stand	Recessed Unit	LH Door Swing, Hinges on Left	Keyed Door Lock	Temperature Recorder	220/240 V, 50/60 HZ	Pass Through Chamber
Option Extension	18	G	MB	MS	R	LH	DL	TR	220	P

For Example: Model # FHCDWC24 with the 18" depth option, Glass Doors, Recessed unit, Hinges on the left, Keyed door lock, 220/240 V 50/60 HZ = Order Model # FHCDWC24-18-G-R-LH-DL-220

If you require any assistance please call us with any questions at (407) 322-3672 or toll free at 1-800-282-8644.

Standard Models

Model #	Outside Dimensions
Triple Chamber Units	
FHCTWC24	30"W x 26.5"D x 78.25"T
FHCTWC24-G	30"W x 26.5"D x 78.25"T
Double Chamber Units	
FHCDWC24	30"W x 26.5"D x 74.5"T
FHCDWC24-G	30"W x 26.5"D x 74.5"T
FHCDWC2424	24"W x 26.5"D x 74.5"T
FHCDWC2424-G	24"W x 26.5"D x 74.5"T
FHCDWC2460	24"W x 20.5"D x 64.75"T
FHCDWC2460-G	24"W x 20.5"D x 64.75"T
FHCDWC36	30"W x 26.5"D x 74.5"T
FHCDWC36-G	30"W x 26.5"D x 74.5"T
FHCDWC60	30"W x 20.5"D x 64.75"T
FHCDWC60-G	30"W x 20.5"D x 64.75"T
Single Chamber Units	
FHCSWC1518	18"W x 15.5"D x 22"T
FHCSWC1518-G	18"W x 15.5"D x 22"T
FHCSWC1824	24"W x 20.5"D x 24.5"T
FHCSWC1824-G	24"W x 20.5"D x 24.5"T
FHCSWC24	30"W x 26.5"D x 24.5"T
FHCSWC24-G	30"W x 26.5"D x 24.5"T
FHCSWC2460	24"W x 20.5"D x 64.75"T
FHCSWC2460-G	24"W x 20.5"D x 64.75"T
FHCSWC36	30"W x 26.5"D x 36"T
FHCSWC36-G	30"W x 26.5"D x 36"T
FHCSWC60	30"W x 20.5"D x 64.75"T
FHCSWC60-G	30"W x 20.5"D x 64.75"T
FHCSWC72	30"W x 26.5"D x 74.5"T
FHCSWC72-G	30"W x 26.5"D x 74.5"T

NOTE: Due to the vast number of sizes we have available, not all of our models are shown. Please let us know your specific dimensions to get the model that will best suit your needs. If we don't currently have the size you need, we will build a custom one for you!

Warranty

All warming cabinets manufactured by Future Health Concepts, Inc. (FHC) will carry a lifetime guarantee against product craftsmanship, **1-year labor and 5-year parts guarantee.** The factory will service all units without cost to the buyer for 1-year from shipment. After the 1-year period, replacement of a defective part (labor) will be at buyer's expense. We will exchange all defective parts at no cost to the buyer for a period of 5-years from shipment. All defective parts must be returned within 30 days to ensure proper credit. An RA from Future Health Concepts, Inc. must be obtained prior to items return.

Blanket & Fluid Warmers

Blanket & Fluid Warmer Storage Information:

Model #	Total Cubic Feet	# of Blankets*	# of Solution 1 Liter Bottles	# of 1/2 Liter Bottles
FHCSWC1518	1.40	1-2	9	-
FHCSWC1824	3.00	6-9	20	-
FHCSWC24	5.27	9-14	36	-
FHCSWC2460	9.73	30-40	66	-
FHCSWC36	8.63	24-30	72	-
FHCSWC60	13.05	50-65	89	-
FHCSWC72	21.00	65-85	143	-
FHCDWC24 Lower Chamber	11.93	35-50	-	-
FHCDWC2424 Lower Chamber	11.93	35-50	-	-
FHCDWC2460 Lower Chamber	4.80	14-22	-	-
FHCDWC36 Lower Chamber	8.96	24-30	-	-
FHCDWC60 Lower Chamber	6.27	12-16	-	-
FHCTWC24 Lower Chamber	6.4	12-16	-	-
30" Roll-out Basket	-	-	30	42
1824 Roll-out Basket	-	-	16	20

***Number of blankets will depend on thickness of blankets, positioning, and fold.**

Surgical Tables

- Future Health Concepts manufactures surgical and operating room tables that are built for today's procedures and patients. We understand that hospitals and surgical centers need medical equipment that meets the demanding needs of modern medicine is critical.

Our FHC1000 Series offers an innovative, compact design while maintaining enough clinical versatility to accommodate surgical procedures in nearly all fields, including urology, neurology, orthopedics and cardiology.

FHC1000S Surgical Table

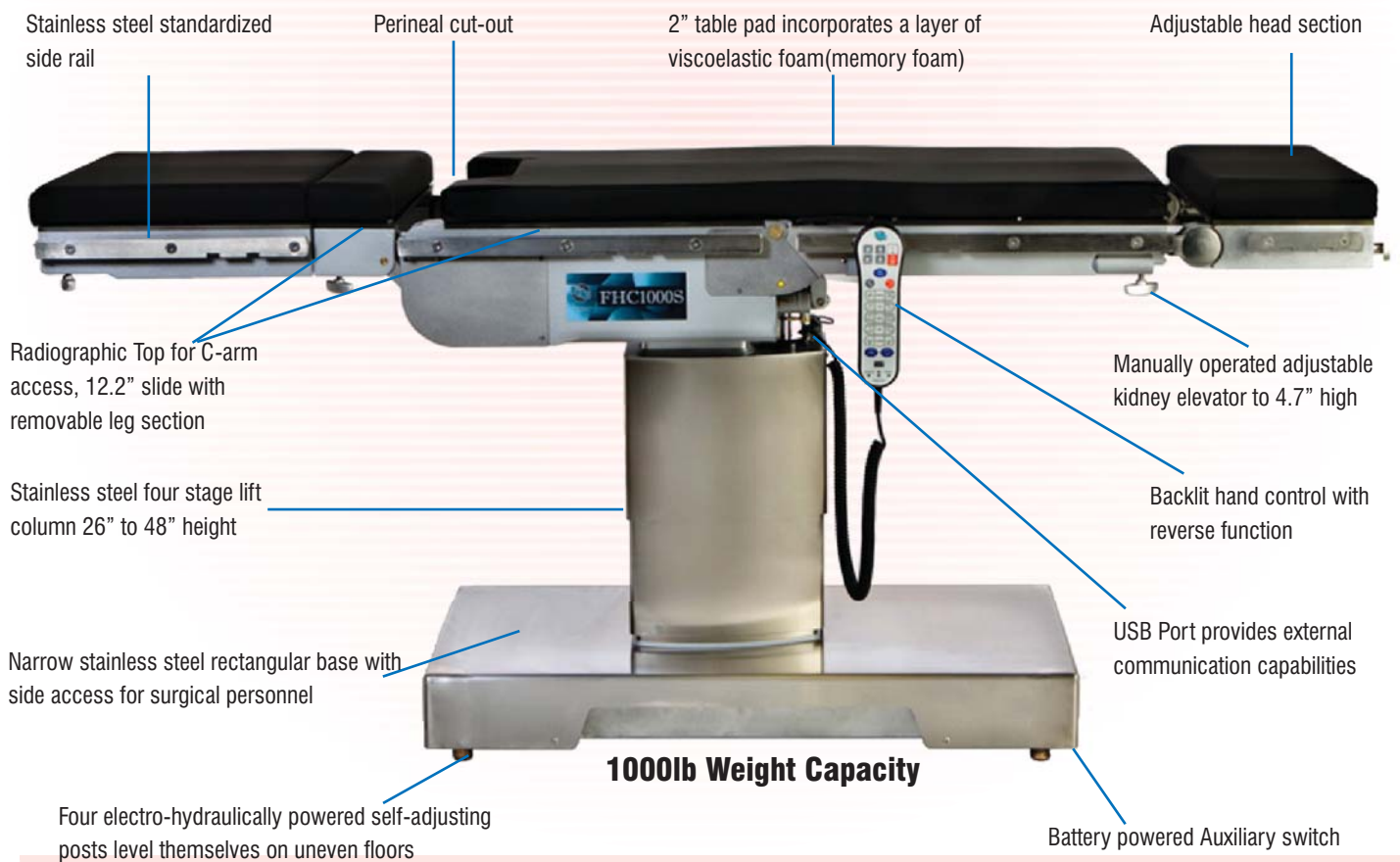

Lithotomy



Neurosurgery



Lumbar

Electrical Specifications:

Power Requirements:
AC 110V/5A, 300W, 50/60Hz or
AC 220/3A, 300W, 50/60Hz; single phase

Current Leakage: <100 microamps
Power Cord: 15 feet



Surgical Tables

C-Arm Imaging for Every Part of the Body

The intelligent design of the table provides benefits such as remarkable C-arm access, self diagnosis with instant error code display and the prevention of sectional conflict.

In addition to the durable, rust-free components, the FHC1000 also incorporates several fail-safe functions to ensure its continuous operation.

Model # FHC1000S

Normal orientation slid to head end (head + leg extension + table)

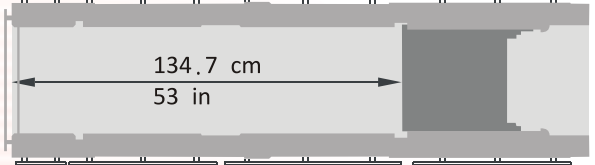

Normal orientation slid to head end

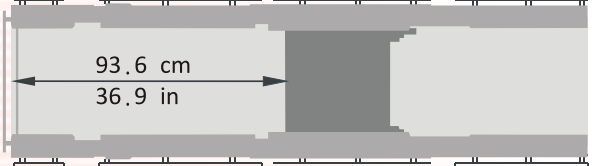

Normal orientation slid to leg end

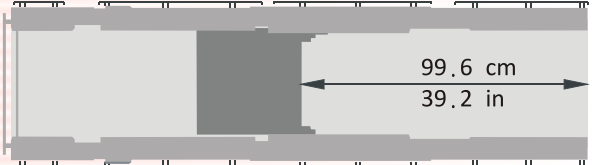

Reverse orientation slid to leg end

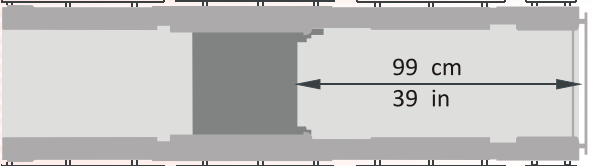

Reverse orientation slid to head end

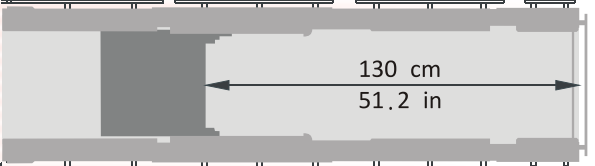

Model # FHC1000

Normal orientation (head + leg extension + table)

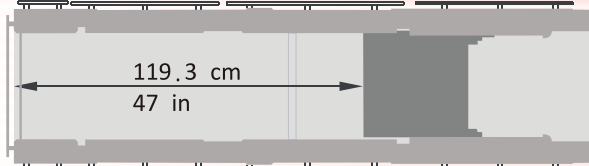

Normal orientation

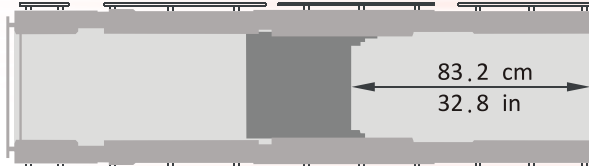

Reverse orientation

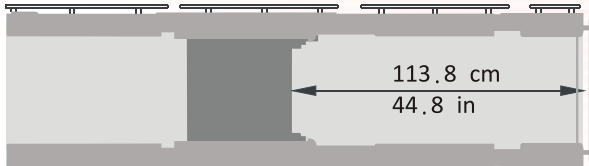

(FHC1000 shown above)



(FHC1000S shown above)

Override System

The override control system allows operation of basic functions should the hand pendant become inoperative.



Surgical Tables

Range of Table Movements

The FHC1000 Series has exceptional positioning capabilities. Designed to simplify patient positioning, the table also features a notably sturdy and low-profile base, ensuring surgeon comfort and therefore reducing fatigue during long procedures.



Hand Pendant

The ergonomic hand pendant's backlit display illuminates the buttons, an essential feature for endoscopic surgery. The intelligent patient orientation function automatically interprets positioning commands according to the selected orientation. Functions such as LOCK, UNLOCK, LEVEL, FLEX, and REFLEX help quick and safe positioning. Most of the possible sectional conflicts are paused by the control system; also the user is informed by the INTERLOCK LED and a warning sound.

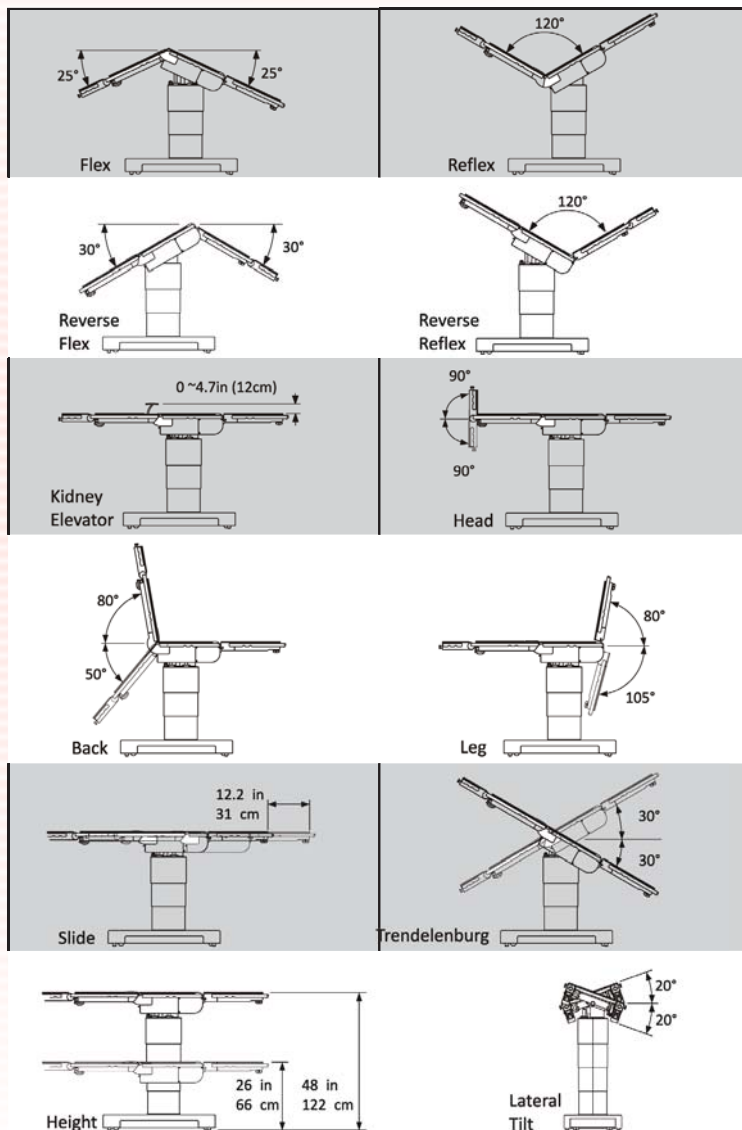

Foot Pump

A second source of hydraulic power. (optional)



Self Diagnosis Instant Error Code Display

A battery level indicator on the base panel displays the service code when the Service LED on the hand pendant is lit.



Built-in X-ray Cassette Channels

Having 14" wide X-ray cassettes channels beneath the entire table length eliminates the need for X-ray tabletops, thus making tabletop articulations possible and increasing patient safety.



Surgical Tables

FUTURE HEALTH CONCEPTS, INC.

Brand/Model		FHC1000	Steris 3085 SP	Maquet 1132 (ALPHASTAR)	Berchtold Operon B810	Berchtold Operon B710	Berchtold Operon D750	
Tabletop	Number of Tabletop Sections	4	4	different options	4	5	4	
	Built-in Kidney Elevator	Yes	Yes	No	Yes	No	Yes	
	Type of Leg Section	Single Plate	Removable extension	Removable	Removable	Removable	Removable	Removable
		Split Plates	Accessory	Accessory	Accessory	No	Accessory	Accessory
	Frame Material	Aluminum Alloy	Aluminum Alloy	Stainless Steel	Aluminum Alloy	Aluminum Alloy	Aluminum Alloy	
	Cassette Tunnel Width	14" entire table	12"	14" entire table	14"	14"	14"	
	Accessory Anti-Falling Device	Yes	Yes	Yes	Yes	Yes	Yes	
	Max. Load lbs (kg)	Normal Orientation	1000 (454)	1000 (454)	990 (450) (for "plus")	600 (273)	770 (350)	750 (341)
Reverse Orientation		1000 (600 when slid)	500 (227)	500 (225)	600 (273)	770 (350)	500 (227)	
Pad	Antistatic Surface	Yes	Yes	Yes	Yes	Yes	Yes	
	Pressure Relief	Yes	Yes	Yes	Yes	Yes	Yes	
	Flame-Retardant (117 & 129)	Yes	Yes	Yes	Yes	Yes	Yes	
Base	Cover Material	SUS # 304	Stainless steel	glass-fiber reinforced	Plastic	Plastic	Plastic	
	Swivel Casters / Straight Casters	4 swivel	4 swivel	4 swivel	4 swivel	4 swivel	4 swivel	
	Number of Floor Posts	4	3	3	4	4	4	
Powered Functions	Floor Locks	Yes	Yes	Yes	Yes	Yes	Yes	
	Height	Yes	Yes	Yes	Yes	Yes	Yes	
	Trendelenburg/Reverse	Yes	Yes	Yes	Yes	Yes	Yes	
	Lateral Tilt	Yes	Yes	Yes	Yes	Yes	Yes	
	Back Section	Yes	Yes	Yes	Yes	Yes	Yes	
	Shoulder Section	N/A	N/A	N/A	N/A	N/A	N/A	
	Leg Section	Yes	Yes	Yes	Yes	Yes	Yes	
	Kidney Elevator	No	No	N/A	Yes	N/A	N/A	
	Longitudinal Slide	N/A	N/A	N/A	Yes	N/A	N/A	
	Table Transport	No	No	Yes, optional	N/A	Yes, optional	N/A	
	Auto Leveling	Yes	Yes	Yes	Yes	Yes	Yes	
	Flex/Reflex	Yes	Yes	Yes	Yes	Yes	Yes	
	Position Memory	No	No	No	No	No	No	
	Self Diagnosis	Integrated Error Codes	No	No	External E-service	External E-service	External E-service	
Backlit Hand Pendant	Yes	No	Yes	Yes	Yes	No		
Range of movement	Height, inches(mm)	26-48" (660 - 1220)	27-44" (686 - 1118)	depends on model	28 - 48" (700 - 1220)	28 - 45" (710 - 1140)	26 - 40.5" (660 - 1029)	
	Trendelenburg /Reverse	30°/30°	25°/25°	30°/30°	30°/30°	30°/30°	30°/31°	
	Lateral Tilt	20°/20°	18°/18°	18°/18°	20°/20°	20°/20°	20°/20°	
	Back Section	80° to -50°	55° to -25°	68° to -25°	80° to -45°	70° to -70°	90° to -45°	
	Shoulder Section	N/A	N/A	N/A	N/A	N/A	N/A	
	Head Section	90° to -90°	90° to -90°	N/A	90° to -90°	90 to -90	40° to -85°	
	Leg Section	up/down	80° to -105°	80° to -105°	80° to -105°	2° to -105°	70° to -90°	30° to -105°
		left/right	N/A	N/A	N/A	N/A	90°	90°
	Kidney Elevator Height, inch(cm)	4.72" (12)	4" (10)	N/A	3" (7.6)	N/A	3.1" (7.8)	
Longitudinal Sliding, inch(cm)	12"	N/A	N/A	12" (30.5)	N/A	N/A		
Fail Safe	Override Control	Yes	Yes	Yes	Yes	Yes	Yes	
	Built-in Battery	Yes	Yes	Yes	Yes	Yes	Yes	
	Foot Pump	Only for FHC1000SK P	Y	N	Yes	No, but hand-ratchet	No	

Surgical Tables

FUTURE HEALTH CO
SETTING THE INDUSTRY

Brand/Model		FHC1000S	Steris Cmax	Steris 5085 SRT	Berchtold Operon D850	
Tabletop	Number of Tabletop Sections		4	4	4	
	Built-in Kidney Elevator		Yes	Yes	Yes	
	Type of Leg Section	Single Plate	Extension is removable	Removable	Removable	Removable
		Split Plates	Accessory	Accessory	Accessory	Accessory
	Frame Material		Aluminum alloy	Stainless steel	Stainless steel	Aluminum Alloy
	Cassette Tunnel Width		14" (36 cm) (entire table)	?	?	14" (36) entire table
	Accessory Anti-Falling Device		Yes	Yes	Yes	Yes
Max. Load lbs (kg)	Normal Orientation	1000 (454)	1100 (500)	1000 (454)	1000 (454)	
	Reverse Orientation	600 (273) slid out	600 (273) w/ positioning	600(273) w/ positioning	N/A	
Pad	Antistatic Surface		Yes	Yes	Yes	
	Pressure Relief		Yes	Yes	Yes	
	Flame-Retardant (117 & 129)		Yes	Yes	Yes	
Base	Cover Material		SUS #304	SUS #304	SUS #304	Plastic
	Swivel Casters / Straight Casters		Apr-00	Apr-00	Apr-00	Apr-00
	Number of Floor Posts		4, self-leveling	4, self-leveling	4, self-leveling	4, self-leveling
Powered Functions	Floor Locks		Yes	Yes	Yes	Yes
	Height		Yes	Yes	Yes	Yes
	Trendelenburg/Reverse		Yes	Yes	Yes	Yes
	Lateral Tilt		Yes	Yes	Yes	Yes
	Back Section		Yes	Yes	Yes	Yes
	Shoulder Section		N/A	N/A	N/A	N/A
	Leg Section		Yes	Yes	Yes	Yes
	Kidney Elevator		No	Yes	Yes	Yes
	Longitudinal Slide		Yes	Yes	Yes	Yes
	Table Transport		No	No	Yes	Yes
	Auto Leveling		Yes	Yes	Yes	Yes
	Flex/Reflex		Yes	Yes	Yes	Yes
	Position Memory		No	No	No	No
	Self Diagnosis		Integrated error code	External e-service	External e-service	External E-service
Backlit Hand Pendant		Yes	No	No	Yes	
Range of movement	Height, inches(mm)		26"- 48" (660 - 1220)	26"- 45" (675 - 1136)	22.8"- 42.5" (581-1080)	22.6" - 46.4" (570-1180)
	Trendelenburg /Reverse		30°/30°	30°/30°	30°/30°	30°/31°
	Lateral Tilt		20°/ 20°	20°/ 20°	20°/ 20°	20°/20°
	Back Section		80° to -50°	90° to -40°	80° to -40°	90° to -45°
	Shoulder Section		N/A	N/A	N/A	N/A
	Head Section		90° to -90°	90 to -90°	60° to -90°	90° to -90°
	Leg Section	up/down	80° to -105°	0 to -105°	0 to -105°	0° to -105°
		left/right	N/A	N/A	N/A	N/A
	Kidney Elevator Height, inch(cm)		4.72" (12)	4.33" (11)	4.33" (11)	3.7" (9.4)
Longitudinal Sliding, inch(cm)		12.2" (31)	18" (45.4)	18" (45.4)	17" (43)	
Fail Safe	Override Control		Y	Y	Y	Yes
	Built-in Battery		Y	Y	Y	Yes
	Foot Pump		Only for FHC1000SKP	Y	N	Yes

Surgical Tables

CONCEPTS, INC.
STANDARD

800.282.8644 | www.fhcusa.com

1211 E. 30th Street | Sanford, FL 32773

Maquet 1133	Trumpf Titan	Skytron 6701	Skytron 6002	Skytron 3501
4 (+options)	2 (+ options)	4	4	3
No	No	Yes	Yes	N/A
N/A	N/A	N/A	N/A	N/A
Removable	Removable	N/A	N/A	N/A
Aluminum Alloy	Stainless Steel	N/A	N/A	N/A
14" (36) entire table	?	N/A	N/A	N/A
Yes	No	Yes	Yes	Yes
792 (360)	990 (450)	1200	600	700
N/A	N/A	1000 articulate	600	600
Yes	Yes	N/A	N/A	N/A
Yes	No	N/A	N/A	N/A
?	No	N/A	N/A	N/A
Fiberglass?	SUS #304	N/A	N/A	N/A
Apr-00	Apr-00	N/A	N/A	N/A
3	4	4	4	4
Yes	Yes	Yes	Yes	Yes
Yes	Yes	Yes	Yes	Yes
Yes	Yes	Yes	Yes	Yes
Yes	Yes	Yes	Yes	Yes
Yes	Yes	Yes	Yes	Yes
No	No	N/A	N/A	N/A
Yes	Yes	Yes	Yes	Yes
N/A	N/A	Yes	Yes	N/A
Yes	Yes	Yes	N/A	Yes
Optional	Yes	N/A	N/A	N/A
Yes	Yes	Yes	Yes	Yes
Yes	Yes	Yes	Yes	Yes
Yes	No	N/A	N/A	N/A
Viewed on wall mount	External E-service	N/A	N/A	N/A
No	No	Yes	N/A	Yes
23" – 42"(594 – 1056)	25" – 44" (630 – 1130)	23"-41"	28"-43"	26"-45"
30°/30°	40°/40°	30°/30°	30°/30°	25°/20°
20°/20°	25°/25°	30°	30°	30°
80° to -40°	85° to -45°	90° to -40°	90° to -40°	90° to -40°
90° to -45° (manual)	90° to -60° (manual)	N/A	N/A	N/A
45° to -45°	?	N/A	N/A	N/A
10° to -90°	90° to -90°	20° to -100°	horizontal to -105°	2° to -98°
90°, double joints	90°, double joints	N/A	N/A	N/A
N/A	N/A	4.5"	4.5"	N/A
9" (23)	12" (30)	N/A	N/A	21"
Yes	Yes	N/A	N/A	N/A
Yes	Yes	Yes	Yes	N/A
No, but hand-ratchet	No	N/A	N/A	N/A

Surgical Tables



BI058-840

Biodex C-Arm 840 Surgical Table:

- Low attenuation carbon fiber tabletop, w/ choice of standard contoured or rectangular design
- Contoured tabletop features face cutout for comfortable prone positioning
- High-speed actuators assure quick, 3 axis, motorized, tabletop positioning
- Includes hand & foot-operated controllers
- Free-float X-Y tabletop
- 500-lb patient capacity
- Low profile base for C-Arm clearance
- Accessory rails
- Both AC & battery power are standard

The Biodex Surgical C-Arm Table 840 is designed for image-guided procedures where stability, access, and precise, quiet, vibration-free positioning are essential. A cantilevered low attenuation carbon fiber tabletop, w/ choice of contoured or rectangular design, accommodates portable or ceiling-suspended C-Arms. The extra-large radiolucent area, free-float X-Y tabletop, motorized control of height, lateral roll, Trendelenburg motions and catheter tray extension make the Biodex 840 Surgical C-Arm Table ideal for cardiovascular procedures.

The Biodex 846 Surgical C-Arm Table is designed for procedures where stability, access and precise, quiet, vibration-free positioning are essential. A cantilevered low attenuation carbon fiber tabletop, w/ choice of contoured or rectangular design, accommodates portable or ceiling-suspended C-Arms. The standard contoured top of the Biodex 846 surgical table, allows ample workspace for anesthesiologists, yet the narrowness required for cervical procedures. The rectangular top offers additional space to allow for superior image quality for long-leg runoff studies and is an ideal surgical table for both pain care and cardiovascular applications.



BI058-846

Biodex C-Arm 846 Surgical Table:

- Low attenuation carbon fiber tabletop, w/ choice of standard contoured or rectangular design
- Contoured tabletop features face cutout for comfortable prone positioning
- High-speed actuators assure quick, 3 axis, motorized, tabletop positioning
- Includes hand & foot-operated controllers
- Free-float X-Y tabletop
- 500-lb patient capacity
- Low profile base for C-Arm clearance
- Accessory rails

Surgical Tables



BI058-870

Biodex Pain Management C-Arm 870 Surgical Table:

- Measures 93" L x 26" with OR accessory rails
- Table top measures: 90" L x 24" W
- 2" thick mattress
- Height adjustable from 30" to 40"
- Trendelenburg 0° to 20°
- Reverse trendelenburg 0° to 20°
- Lateral roll 0° to 20°
- Hand control actuates all motions
- Locking 5" swivel casters
- 500 lb. weight capacity
- 115 VAC or 230 VAC
- Low profile base for C-arm clearance

The Biodex Pain Management C-Arm 870 operating table is carefully constructed to provide enhanced stability, access, and precise, quiet, vibration-free positioning during usage. With a low attenuation carbon fiber tabletop and high-speed actuators for quick, three axis motorized tabletop positioning, the Pain Management C-arm surgical table ensures each operator gets flexible and easy pain care management available. A 2 inch thick mattress and 500 pound weight capacity provides comfortability for even some of the heaviest patients. The choice of standard contoured or rectangular design allows customers to select the tabletop that best fits the need to achieve maximum image resolution.



BI058-800

Biodex C-Arm 800 Urology Table:

- Large radiolucent area, 54" x 17.5"
- Fowler positioning (0° to 80°)
- 5 axis motorized tabletop positioning
- Hand-held & foot-operated controllers
- Smooth starts and stops programmed into all motorized movements
- Low profile base for C-Arm clearance
- Accessory rails
- Both AC and battery power are standard

The Biodex 800 Urology C-Arm Table is an ideal choice for image-guided procedures. The narrow Fiberesin(TM) tabletop is cantilevered to accommodate portable or ceiling suspended C-Arms. The urology table also features motorized actuation of height, X-Y, lateral roll and Trendelenburg motions of the tabletop. The table comes equipped with a lightweight, non-imaging patient transfer extension and a radiolucent extension. With standard Both AC and battery power, the Biodex 800 Urology Table provides functional designs for complete access while minimizing radiation exposure to clinicians.

Surgical Tables



BI058-810

Biodex C-Arm 810 Brachytherapy Table:

- Large radiolucent area, 54" x 17.5"
- Fowler positioning (0° to 80°)
- 5 axis motorized tabletop positioning
- Hand-held & foot-operated controllers
- Smooth starts and stops programmed into all motorized movements
- Low profile base for C-Arm clearance
- Accessory rails
- Both AC and battery power are standard

The Biodex C-Arm 820 3D Imaging Table is designed and equipped for use with 3D C-Arm for seed implantation, urology, thoracic/vascular and other general C-Arm applications. The table features motorized actuation of height, X-Y, lateral roll and Trendelenburg motions of the tabletop. The hand-held and foot-operated controllers can be positioned for access from any point around the table and ensure quick and safe tabletop positioning during any phase of a procedure. The 3D Imaging Table comes equipped with a lightweight, non-imaging patient transfer extension and a radiolucent extension.



BI058-820

Biodex C-Arm 820 3D Imaging Table:

- Large radiolucent area, total length 51.5"
- 5 axis motorized tabletop positioning
- Low attenuation carbon fiber tabletop
- Hand-held & foot-operated controllers
- Smooth starts and stops programmed into all motorized movements
- Low profile base for C-Arm clearance
- Exceptional platform for pelvic Brachytherapy & 3D Urology procedures
- Ideal for 3D imaging of breasts and thorax
- Accessory rails
- Both AC and battery power are standard

Surgical Tables

Carbon Fiber X-Ray Imaging Table:

- Diving board style for easy c-arm access
- Large patient capacity- 500 pound load
- 2" patient high quality comfort pad
- Facial Cut-out for prone procedures
- Lightweight - easy to physically move the table
- 24" top eliminates need for arm boards
- Simple to use top quality wheel locks
- Easy patient transfer to table

FHC Streamline SUSL-1 Imaging Table:

High-low 28" to 38" 120v

FHC Streamline SUSL-2 Imaging Table:

High-low 28" to 38", and lateral tilt (+-) 17°, 120v,

FHC Streamline SUSL-3 Imaging Table:

High-low 28" to 38", lateral tilt (+-) 17°, and trendelenburg (+-) 20°, 120v

FHC Streamline SUSL-4 Imaging Table:

High-low 28" to 38", lateral tilt (+-) 17°, and trendelenburg (+-) 20°, and longitudinal slide of 10" head to foot (plus or minus 5"), 120v

FHC Streamline SUSL-5 Imaging Table:

High-low 28" to 38", lateral tilt (+-) 17°, and trendelenburg (+-) 20°, longitudinal slide of 10" head to foot (plus or minus 5"), and lateral side to side 10" (plus or minus 5"), 120v

***Three Year Parts & Labor Warranty**

Carbon fiber top of 24" width eliminates need for armboards and 84" length can accommodate even the tallest patients

(Vascular & Urology Imaging X-Ray Tables also available)

Face Access Hole

Easy to use handswitch with power on indicator

2" thick high quality patient comfort pad

FHC-SUSL

High end actuator motor can lift over 500 pound load

Lightweight, which makets it easy for staff to move the table around the room or room to room

Surgical Tables

We carry pads for all your favorite brand name surgical tables as well as customizable pads for manufacturers' we may not have!

Berchtold B810, B710

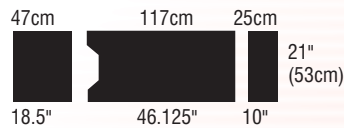

Midmark Chic CST

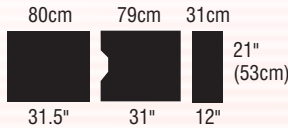

Skytron 3501B

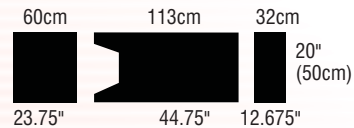

Berchtold Operon D850, D750

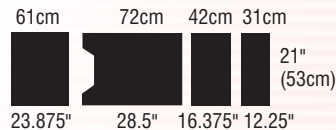

Midmark Montreal

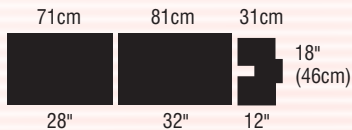

Skytron 3600

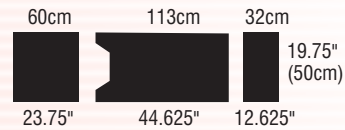

Maquet/Siemens 1130

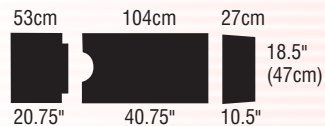

Getinge/Shampaine 1400/1500/1900

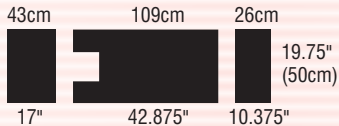

Skytron 6700, 6701

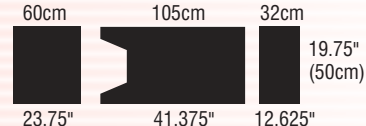

Maquet 1130 Split Leg

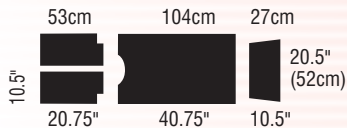

Getinge/Shampaine 1501 Radi-Op

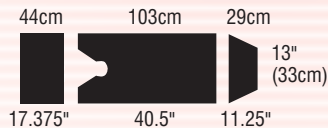

Steris-Amsco 1080, 2080



Maquet 1130 Orthopedic

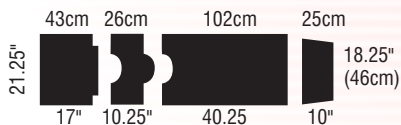

Getinge/Shampaine 4900/5100B, 5100E

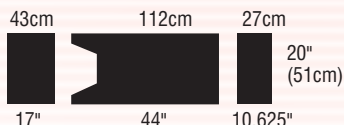

Steris-Amsco 1080, 2080 w/Leg Ext.

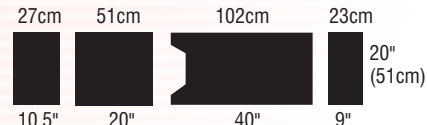

Maquet Alphamaxx

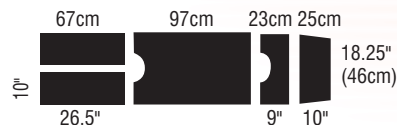

Skytron 5001, 6001, 6500, 6600



Steris-Amsco 3080, 3085

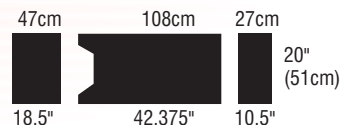

Maquet Alphastar 1132

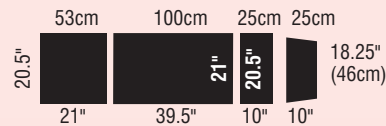

Skytron 3100

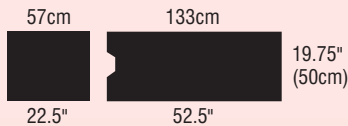

Steris-C-Max

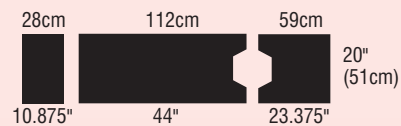

Midmark 7100

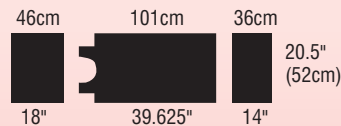

Skytron 3500

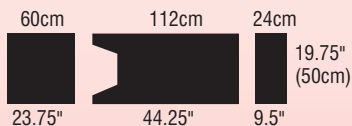

Steris Surgi-Graphic 6000



Surgical Tables

Types of Surgical Table Pads:

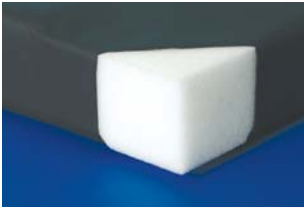

Standard

Consists of standard open cell high density polyurethane foam with a Lectrolite™ Cover. Meets OEM Specifications.



Deluxe

Consists of standard open cell high density polyurethane foam with a multidirectional stretch anti-shear Fusion™ Cover. Exceeds OEM specifications.



Deluxe Gel

consists of standard open cell high density polyurethane foam support layer with a top layer of polymer gel all covered with a multidirectional stretch anti-shear Fusion™ Cover.



Softcare

Consists of high density polyurethane foam support layer with a top layer of memory foam covered with a multidirectional stretch anti-shear Fusion™ Cover. Exceeds OEM specifications.



Softcare w/ Gel

Consists of a closed cell rubber anti-bottoming layer then a high density polyurethane foam support layer with a top layer of memory foam covered with a multidirectional stretch anti-shear Fusion™ Cover.

Surgical Tables

		STANDARD		DELUXE		DELUXE GEL				
		US	2"	3"	2"	3"	2.25"	3.25"	4.25"	5.25"
		METRIC	5cm	8cm	5cm	8cm	6cm	8cm	11cm	13cm
A	Berchtold B810, B710	BBB810	BBB810-3	BBB810D	BBB810D-3	BBB810DG	BBB810DG-3	BBB810DG-4	BBB810DG-5	
B	Berchtold Operon D850, D750	BBD850	BBD850-3	BBD850D	BBD850D-3	BBD850DG	BBD850DG-3	BBD850DG-4	BBD850DG-5	
C	Maquet/Siemens 1130	BB1130	BB1130-3	BB1130D	BB1130-3	BB1130DG	BB1130DG-3	BB1130DG-4	BB1130DG-5	
D	Maquet 1130 Split Leg	BB1130-SL	BB1130-SL-3	BB1130-SLD	BB1130-SLD-3	BB1130-SLDG	BB1130-SLDG-3	BB1130-SLDG-4	BB1130-SLDG-5	
E	Maquet 1130 Orthopedic	BB1130-0	BB1130-0-3	BB1130-0D	BB1130-0D-3	BB1130-0DG	BB1130-0DG-3	BB1130-0DG-4	BB1130-0DG-5	
F	Maquet Alphamaxx	BBALPMAX	BBALPMAX-3	BBALPMAX-D	BBALPMAX-D3	BBALPMAX-DG	BBALPMAX-DG3	BBALPMAX-DG4	BBALPMAX-DG5	
G	Maquet Alphastar 1132	BBALPSTR	BBALPSTR-3	BBALPSTR-D	BBALPSTR-D3	BBALPSTR-DG	BBALPSTR-DG3	BBALPSTR-DG4	BBALPSTR-DG5	
H	Midmark 7100	BBMI7100	BBMI7100-3	BBMI7100-D	BBMI7100-D3	BBMI7100-DG	BBMI7100-DG3	BBMI7100-DG4	BBMI7100-DG5	
I	Midmark Chic CST	BBMIDCST	BBMIDCST-3	BBMIDCST-D	BBMIDCST-D3	BBMIDCST-DG	BBMIDCST-DG3	BBMIDCST-DG4	BBMIDCST-DG5	
J	Midmark Montreal	BBMIMONT	BBMIMONT-3	BBMIMONT-D	BBMIMONT-D3	BBMIMONT-DG	BBMIMONT-DG3	BBMIMONT-DG4	BBMIMONT-DG5	
K	Getinge/Shampaine 1400/1500/1900	BB1400	BB1400-3	BB1400-D	BB1400-D3	BB1400-DG	BB1400-DG3	BB1400-DG4	BB1400-DG5	
L	Getinge/Shampaine 1501 Radi-Op	BB1501	BB1501-3	BB1501-D	BB1501-D3	BB1501-DG	BB1501-DG3	BB1501-DG4	BB1501-DG5	
M	Getinge/Shampaine 4900/5100B, 5100E	BB4900	BB4900-3	BB4900-D	BB4900-D3	BB4900-DG	BB4900-DG3	BB4900-DG4	BB4900-DG5	
N	Skytron 5001, 6001, 6500, 6600	BB5001	BB5001-3	BB5001-D	BB5001-D3	BB5001-DG	BB5001-DG3	BB5001-DG4	BB5001-DG5	
O	Skytron 3100	BB3100	BB3100-3	BB3100-D	BB3100-D3	BB3100-DG	BB3100-DG3	BB3100-DG4	BB3100-DG5	
P	Skytron 3500	BB3500	BB3500-3	BB3500-D	BB3500-D3	BB3500-DG	BB3500-DG3	BB3500-DG4	BB3500-DG5	
Q	Skytron 3501B	BB3501B	BB3501B-3	BB3501B-D	BB3501B-D3	BB3501B-DG	BB3501B-DG3	BB3501B-DG4	BB3501B-DG5	
R	Skytron 3600	BB3600	BB3600-3	BB3600-D	BB3600-D3	BB3600-DG	BB3600-DG3	BB3600-DG4	BB3600-DG5	
S	Skytron 6700, 6701	BB6700	BB6700-3	BB6700-D	BB6700-D3	BB6700-DG	BB6700-DG3	BB6700-DG4	BB6700-DG5	
T	Steris-Amsco 1080, 2080	BB2080	BB2080-3	BB2080-D	BB2080-D3	BB2080-DG	BB2080-DG3	BB2080-DG4	BB2080-DG5	
U	Steris-AMSCO 1080/2080 w/Leg Ext.	BB2080L	BB2080L-3	BB2080L-D	BB2080L-D3	BB2080L-DG	BB2080L-DG3	BB2080L-DG4	BB2080L-DG5	
V	Steris-Amsco 3080, 3085	BB3080	BB3080-3	BB3080D	BB3080D-3	BB3080DG	BB3080DG-3	BB3080DG-4	BB3080DG-5	
W	Steris C-Max	BBCMAX	BBCMAX-3	BBCMAXD	BBCMAXD-3	BBCMAXDG	BBCMAXDG-3	BBCMAXDG-4	BBCMAXDG-5	
X	Steris Surgi-Graphic 6000	BB6000	BB6000-3	BB6000D	BB6000D-3	BB6000DG	BB6000DG-3	BB6000DG-4	BB6000DG-5	

Surgical Tables

		SOFTCARE				SOFTCARE W/ GEL				
		US	2"	3"	4"	5"	2.25"	3.25"	4.25"	5.25"
		Metric	5cm	8cm	10cm	13cm	6cm	8cm	11cm	13cm
A	Berchtold B810, B710	BBB810SF	BBB810SF-3	BBB810SF-4	BBB810SF-5	BBB810SF-G	BBB810SF-G-3	BBB810SF-G-4	BBB810SF-G-5	
B	Berchtold Operon D850, D750	BBD850SF	BBD850SF-3	BBD850SF-4	BBD850SF-5	BBD850SF-G	BBD850SF-G-3	BBD850SF-G-4	BBD850SF-G-5	
C	Maquet/Siemens 1130	BB1130SF	BB1130SF-3	BB1130SF-4	BB1130SF-5	BB1130SF-G	BB1130SF-G-3	BB1130SF-G-4	BB1130SF-G-5	
D	Maquet 1130 Split Leg	BB1130-SLSF	BB1130-SLSF-3	BB1130-SLSF-4	BB1130-SLSF-5	BB1130-SLSF-G	BB1130-SLSF-G-3	BB1130-SLSF-G-4	BB1130-SLSF-G-5	
E	Maquet 1130 Orthopedic	BB1130-O-SF	BB1130-O-SF3	BB1130-O-SF4	BB1130-O-SF5	BB1130-O-SFG	BB1130-O-SFG3	BB1130-O-SFG4	BB1130-O-SFG5	
F	Maquet Alphamaxx	BBALPMAX-SF	BBALPMAX-SF3	BBALPMAX-SF4	BBALPMAX-SF5	BBALPMAX-SFG	BBALPMAX-SFG3	BBALPMAX-SFG4	BBALPMAX-SFG5	
G	Maquet Alphastar 1132	BBALPSTR-SF	BBALPSTR-SF3	BBALPSTR-SF4	BBALPSTR-SF5	BBALPSTR-SFG	BBALPSTR-SFG3	BBALPSTR-SFG4	BBALPSTR-SFG5	
H	Midmark 7100	BBMI7100-SF	BBMI7100-SF3	BBMI7100-SF4	BBMI7100-SF5	BBMI7100-SFG	BBMI7100-SFG3	BBMI7100-SFG4	BBMI7100-SFG5	
I	Midmark Chic CST	BBMIDCST-SF	BBMIDCST-SF3	BBMIDCST-SF4	BBMIDCST-SF5	BBMIDCST-SFG	BBMIDCST-SFG3	BBMIDCST-SFG4	BBMIDCST-SFG5	
J	Midmark Montreal	BBMIMONT-SF	BBMIMONT-SF3	BBMIMONT-SF4	BBMIMONT-SF5	BBMIMONT-SFG	BBMIMONT-SFG3	BBMIMONT-SFG4	BBMIMONT-SFG5	
K	Getinge/Shampaine 1400/1500/1900	BB1400SF	BB1400SF-3	BB1400SF-4	BB1400SF-5	BB1400SFG	BB1400SFG-3	BB1400SFG-4	BB1400SFG-5	
L	Getinge/Shampaine 1501 Radi-Op	BB1501SF	BB1501SF-3	BB1501SF-4	BB1501SF-5	BB1501SFG	BB1501SFG-3	BB1501SFG-4	BB1501SFG-5	
M	Getinge/Shampaine 4900/5100B, 5100E	BB4900SF	BB4900SF-3	BB4900SF-4	BB4900SF-5	BB4900SFG	BB4900SFG-3	BB4900SFG-4	BB4900SFG-5	
N	Skytron 5001, 6001, 6500, 6600	BB5001SF	BB5001SF-3	BB5001SF-4	BB5001SF-5	BB5001SFG	BB5001SFG-3	BB5001SFG-4	BB5001SFG-5	
O	Skytron 3100	BB3100SF	BB3100SF-3	BB3100SF-4	BB3100SF-5	BB3100SFG	BB3100SFG-3	BB3100SFG-4	BB3100SFG-5	
P	Skytron 3500	BB3500SF	BB3500SF-3	BB3500SF-4	BB3500SF-5	BB3500SFG	BB3500SFG-3	BB3500SFG-4	BB3500SFG-5	
Q	Skytron 3501B	BB3501B-SF	BB3501B-SF3	BB3501B-SF4	BB3501B-SF5	BB3501B-SFG	BB3501B-SFG3	BB3501B-SFG4	BB3501B-SFG5	
R	Skytron 3600	BB3600SF	BB3600SF-3	BB3600SF-4	BB3600SF-5	BB3600SFG	BB3600SFG-3	BB3600SFG-4	BB3600SFG-5	
S	Skytron 6700, 6701	BB6700SF	BB6700SF-3	BB6700SF-4	BB6700SF-5	BB6700SFG	BB6700SFG-3	BB6700SFG-4	BB6700SFG-5	
T	Steris-Amsco 1080, 2080	BB2080SF	BB2080SF-3	BB2080SF-4	BB2080SF-5	BB2080SFG	BB2080SFG-3	BB2080SFG-4	BB2080SFG-5	
U	Steris-AMSCO 1080/2080 w/Leg Ext.	BB2080L-SF	BB2080L-SF3	BB2080L-SF4	BB2080L-SF5	BB2080L-SFG	BB2080L-SFG3	BB2080L-SFG4	BB2080L-SFG5	
V	Steris-Amsco 3080, 3085	BB3080SF	BB3080SF-3	BB3080SF-4	BB3080SF-5	BB3080SFG	BB3080SFG-3	BB3080SFG-4	BB3080SFG-5	
W	Steris C-Max	BBCMAX-SF	BBCMAX-SF3	BBCMAX-SF4	BBCMAX-SF5	BBCMAX-SFG	BBCMAX-SFG3	BBCMAX-SFG4	BBCMAX-SFG5	
X	Steris Surgi-Graphic 6000	BB6000SF	BB6000SF-3	BB6000SF-4	BB6000SF-5	BB6000SFG	BB6000SFG-3	BB6000SFG-4	BB6000SFG-5	

Surgical Table Accessories

600 lb. (272 kg)
Patient Wt. Capacity

FACC0055



Simple squeeze of the Trigger Grip Handle for lithotomy and abduction/adduction.

EZ-Lift Power Assist Boot Stirrups with Boot Pads

- 600 lb (272 kg) surgical patient weight capacity
- Boot free-floats throughout each range reducing the risk of superficial nerve injury
- Raise, lower, abduct, adduct quickly and easily with the Trigger Grip handle
- Lithotomy and length indicators help to position and reposition the legs
- Deluxe boot stirrup liners wrap around the foot, ankle and calf providing safe, comfortable and secure patient positioning

Increase your surgeons' operating room performance with the EZ-Lift Power Assist Boot Stirrups which permits simple adjustment of lithotomy and abduction intraoperatively. A simple squeeze of the Trigger Grip trigger provides complete control of lithotomy and abduction/adduction without compromising the sterile field. Simply release the trigger on the handle to securely lock the stirrup in all directions. Quick-connect, blade-mounting style with extended lateral boot system, the EZ-Lift Power Assist Boot Stirrups' range of motion is -35° low lithotomy to 84° high lithotomy. Adduction -9° and abduction 25° , with the control to lock the stirrup anywhere in between. The stirrup ships fully assembled. Boot liners are included. Two required SpringLoc Clamps sold separately.



Organize your accessories with the Stirrup Dolly (left) and Stirrup Wall Rack (right).

Optional Accessories:

FACC0064 - FHC Stirrup Cart

FACC0066 - Stirrup Wall Rack

Required Accessory: (Purchase Two)

FACC0011 SpringLoc Clamp



Surgical Table Accessories

Pediatric EZ-Lift Stirrups

- Floating boot automatically adjusts when repositioning the pediatric boot stirrup
- Range: Abduction +25°, Adduction -9°
- Lithotomy range of +84° to -35°
- Easy-clean Boot Liner Pad safely wraps patient's foot, ankle and leg
- Visual indicators ensure precise patient positioning

FACC0052	Pediatric E-Z Lift Stirrups, PUPS 160 lb (73 kg) patient capacity
FACC0051	Pediatric E-Z Lift Stirrups, KIDS 250 lb (113 kg) patient capacity
FACC0050	Pediatric E-Z Lift Stirrups Bundle Includes 1 pair of each stirrups

Required Accessory: Order Two

FACC0011 SpringLoc Clamp



The Pediatric E-Z Lift Stirrups are as easy-to-use as its forerunner; providing a comfortable, stable boot with an easy-clean boot liner that safely and securely wraps the foot, ankle and leg. Stirrups with the E-Z Lift feature easily control the patient's leg when moving it into the operative position, and have a Trigger Grip Handle that permit simple adjustment of lithotomy, adduction/abduction, and intraoperatively while maintaining a sterile field. Boot adjust with a single clamp, simplifying patient positioning. Boot liners included.



The Pediatric Lithotomy Stirrups are a comfortable boot stirrup with an easy-clean boot liner that is specifically designed with the pediatric patient in mind. Safely and securely wrapping the foot, ankle and leg, the boot adjusts with a single clamp that simplifies patient positioning. Pediatric stirrups attach to side rail of any OR table using the Schure Socket XL (sold separately). Boot liners are included.

Pediatric Lithotomy Stirrups

- Pediatric boot stirrup design encapsulates patient's lower leg
- Floating boot automatically adjusts when repositioning the pediatric boot stirrup
- Replaceable boot liner pad safely wraps patient's foot, ankle and calf
- Single boot clamp makes positioning the patient easy

FACC0073	Pediatric Lithotomy Stirrups, PUPS 160 lb (73 kg) patient capacity
FACC0072	Pediatric Lithotomy Stirrups, KIDS 250 lb (113 kg) patient capacity
FACC0074	Pediatric Lithotomy Stirrups Bundle Includes 1 pair of each stirrups

Required Accessory: Order Two

FACC0011 SpringLoc Clamp

Surgical Table Accessories

800 lb. (363 kg)
Patient Wt. Capacity

FACC0054



Fold-over design
Flexible boot

Maxima Power Assist Boot Stirrups

- 800 lb (363 kg) surgical patient weight capacity
- Boot free-floats throughout each range reducing the risk of superficial nerve injury
- Raise, lower, abduct, adduct quickly and easily with the Trigger Grip Handle
- Lithotomy and length indicators help to position and reposition the legs
- Extended lateral boot design helps reduce the risk of peroneal nerve injury

Increase your surgeons' operating room performance with the EZ-Lift Power Assist Maxima Stirrups which permit simple adjustment of lithotomy and abduction intraoperatively. A simple squeeze of the Trigger Grip Handle provides complete control of lithomy and abduction/adduction without compromising the sterile field. Quick connect blade-mounting style with extended lateral boot system. Deluxe boot stirrup liners wrap around the foot, ankle and calf providing safe, comfortable and secure patient positioning. EZ-Lift Power Assist Maxima Stirrups range of motion is -35° low lithotomy to 84° high lithotomy. Adduction -9° and abduction 25° , with the control to lock the stirrup anywhere in between. The EZ-Lift Power Assist ships fully assembled. Boot liners are included. Two required SpringLoc Clamps sold separately.

Required Accessory: (Purchase Two)
FACC0011 SpringLoc Clamp



Surgical Table Accessories



Uro-Trapper System

- Flexible drape support provides unobstructed surgeon access to surgical site and springs back to original orientation to allow for optimal fluid drainage
- Mounts effortlessly to any surgical table with integral clamps

A flexible system that attaches to any general surgical table to contain fluids for hysteroscopy or cystoscopy procedures.

FACC0030 Uro-Trapper System



Uro-Trapper Drain Bags

- Flexible hose is compatible with all suction systems for accurate fluid measurement
- Durable, drain bags are not made with natural rubber latex

Open mesh filter allows for rapid drainage of fluids.

Tube is 64"L x $\frac{7}{8}$ "D (163cm x 2cm) and 20" (51cm) compressed.

Disposable Uro-Trapper Drain Bags

FACC920-0098 Sterile, 10/cs

FACC0031 Non-Sterile, 10/cs



Disposable Clear View Leg Drapes

The Disposable Clear View Leg Drape allows visibility of patient's leg during intraoperative adjustments. A blue modesty panel is now incorporated within the drape. Packaged sterile and not made with natural rubber latex. Provides continuous monitoring of patient's legs without breaking sterile field.

FACC920-0160 Disposable Clear View Leg Drapes, Sterile, 10/cs

Surgical Table Accessories

Lithotomy Stirrups

- Use for long or short procedures
- Soft boot liners encapsulate feet
- 350 lb (158 kg) patient weight capacity
- Features extended lateral boot support to prevent superficial nerve damage and unwanted leg rotation
- Schure Socket XL sold separately

FACC0071 Lithotomy Stirrups

FACCF-RCP2 Schure Socket XL



Knee Crutches

- Simple to set up and position the patient
- Knee Crutches adjust vertically from 12"-19" (31cm-48cm) and rotate 360° to provide precise positioning with a simple ergonomic locking handle
- Constructed of the highest quality stainless steel
- Extremely soft and comfortable crutch liners prevent superficial nerve damage to the patient. Mount crutches simply with Schure Socket XL (sold separately)

FACC0019 Knee Crutches

FACCF-RCP2 Schure Socket XL



Candy Cane Stirrups

- Adjust vertically from 28"-44" (71cm-112cm) with an 8" (20cm) leg clearance
- 18"L x 1 1/2"W (46cm x 4cm) double-looped, cotton ankle strap
- Lock stirrup height by simply twisting the ergonomic handle
- Connect stirrups to OR table side rail with Schure Socket XL (sold separately)

FACC0020 Candy Cane Stirrups

FACCF-RCP2 Schure Socket XL
358LC Candy Cane Strap Replacement
FACC508-0453 Gel Candy Cane Pole Pad,
25" L x 2" I.D (64 cm x 5cm)



Surgical Table Accessories



FACC0169

Schure Loc™ XPS Positioner

- Securely and safely holds patient arm in any desired position during arthroscopic surgery
- Compact and lightweight
- No foot pedals, hoses, hydraulics or power cords
- Ships assembled and ready for immediate use
- Single lever releases all joints for positioning and re locks when released
- Decreases surgeon fatigue and improves intraoperative control of surgical limb
- Schure Loc™ XPS reduces staffing needs providing a more cost-effective procedure
- Schure Loc™ XPS Shoulder Kit conveniently includes a sterile drape and foam hand/forearm holder, and self-adherent wrap

Schure Loc™ XPS currently outperforms similar equipment for shoulder surgery in both the beach chair and lateral position. The Schure Loc™ XPS is the perfect companion piece for any beach chair positioner—easily attaching to any OR table rail while freeing your surgical assistant to do much more than steady the patient's limb. Get the most from your team by adding this high-quality, easy-to-use device to your shoulder surgery equipment.

Easy as 1, 2, 3

- Squeeze and hold lever to release all device joints
- Position limb in exact position
- Release lever to securely lock into position

FACC0169 Schure Loc™ XPS

Optional Accessory

FACC920-0281 Disposable Schure Loc™ XPS Sterile Kit, 10/cs Includes Sterile Forearm Wrap, Sterile Self-Adherent Coban™ and Sterile Drape.



Surgical Table Accessories

Completely eliminates manual positioning with push-button ease

FACC0043



FHC Powered Beach Chair

- 500 lb (227 kg) patient weight capacity
- Motion-control technology eliminates manual patient positioning
- Lateral Brace attaches to chair and not table side rail
- Pull-away panels providing excellent surgical exposure
- Double-ball joint head rest tilts 30° in every direction
- Five-piece Deluxe pad set included

The FHC Powered Beach Chair is the only chair on the market with a self-contained motor that does not have to rely on the surgical table for power. The double-ball joint head system safely secures patient's head; with even your kyphosis patients. Chair adjusts from 0-90° in 8 seconds in a slow controlled movement. 2" (5cm) Deluxe pad set provides patient comfort. Motion-control technology eliminates manual patient positioning with a simple push button hand control and supports patients up to 500 lbs (227 kgs). Attaches to ANY operating room table with our integrated adjustable mounting clamps. Lateral Brace included.

FACC0043 Powered Beach Chair

Required Accessories: Select One Model
 FACC920-0164 Disposable Face Masks, 12/cs
 FACC920-0039 Disposable Head & Chin Straps, 12/cs

Optional Accessories

FACC0065 Dolly, Shoulder Chair
 FACC0010 Multi-Axis Arm Positioner
 FACCF-RCP2 Schure Socket XL



Disposable Face Mask



Disposable Head & Chin Strap



Multi-Axis Arm Positioner



Schure Socket XL



Shoulder Chair Dolly



Complete Shoulder System includes the Schure Loc™ XPS, Disposable Head & Chin Straps, Multi-Axis Arm Positioner, Schure Socket XL, Disposable Schure Loc™ XPS Sterile Kit and Schure Loc Carrying Case.

Choose Powered Beach Chair or E-Z Lift Beach Chair

FACC0058 Complete Shoulder System w/Schure Loc™ XPS & Powered Beach Chair

FACC0059 Complete Shoulder System w/Schure Loc™ XPS & E-Z Lift Chair

Surgical Table Accessories



FACC0042

FHC EZ-Lift Beach Chair

- Reduces effort when lifting patients compared to manual systems
- Double-ball joint head system safely secures patient's head

The FHC Beach Chair provides a lightweight and cost-effective option to our fully powered shoulder chair. This system employs a powerful piston to lift the patient. Adjusts to fit any OR table with our integrated adjustable mounting clamps. 500 lb (227 kg) patient weight capacity. Articulation range is 0°–90°. Lateral Brace included.

FACC0042 FHC EZ-Lift Beach Chair

Required Accessories: Select One Model

FACC920-0164 Disposable Face Masks, 12/cs

FACC920-0039 Disposable Head & Chin Straps, 12/cs

Optional Accessories

FACC0065 Dolly, Shoulder Chair

FACC0010 Multi-Axis Arm Positioner

FACCF-RCP2 Schure Socket XL



Disposable Face Mask



Disposable Head & Chin Strap



Multi-Axis Arm Positioner



Schure Socket XL



Shoulder Chair Dolly

Complete Shoulder System includes the Shoulder Assistant, Disposable Head & Chin Straps, Multi-Axis Arm Positioner, Shoulder Assistant Dolly, Schure Socket XL and the Disposable Hand / Forearm Wraps.

Choose FHC Beach Chair or Powered Beach Chair

FACC0048 Complete Shoulder Assistant Powered Beach Chair Shoulder System

FACC0060 Complete Shoulder Assistant FHC Chair Shoulder System

Surgical Table Accessories



Shoulder Assistant

- Save money not having to buy expensive drapes
- Surgeon foot control provides quick and precise intraoperative positioning
- Easy-to-assemble
- Shoulder Assistant Dolly sold separately
- Unlimited surgical site access and positioning

The FHC Shoulder Assistant combines strength and adaptability to provide optimal intraoperative positioning for shoulder surgery in the beach chair position. Staff efficiency is improved as the assistants are freed from holding the limb during surgery. Designed to maintain a low profile while delivering exceptional control and positioning capabilities. Mounts onto the side of any standard operating table and provides a non-sterile base for which sterile components are inserted. The upper extremity positioner and control tube are steam autoclavable to provide the sterile environment needed for upper extremity surgery.

FACC0047 Shoulder Assistant

Required Accessory

Disposable Sterile Hand/Forearm Wraps securely holds the hand and forearm during the operative procedure. Quick release for range of motion.

FACC920-0113 Disposable Sterile Hand/Forearm Wraps, 12/cs



FACC920-0039



FACC920-0164



FACC0081

Optional Accessories

FACC920-0039

Disposable Head & Chin Straps, 12/cs

FACC920-0164

Disposable Face Masks, 12/cs

FACC0081

Dolly, Shoulder Assistant

Surgical Table Accessories

Lateral Shoulder Holder

This weightless shoulder system allows for traction settings from 0-25 lbs (0-11 kgs) by simply turning the traction adjustment knob. Internal and external rotation can be easily controlled by the surgeon's preference, and locked in place. It simply attaches to the surgical table side rail. No need for sand bags!

Required CamLoc Clamp sold separately.

FACC0170 Lateral Shoulder Holder

Required Accessories
CamLoc Clamp: Order One
FACC0271

FACC920-0113 Disposable Hand/Forearm Wraps,
Sterile, 12/cs



Wrist Tower

- Simply dial in your tension, eliminating sand bag use
- All components are autoclavable
- Easily attaches to side rail of surgical table w/ CamLoc Clamp (sold separately)
- Improves productivity, eliminating need for assistant to hold extremity

The Wrist Traction Configuration offers a variety of positioning capabilities. You can apply traction by simply dialing the knob from 0-25 lbs (0-11 kgs). Pronation and Supination can be easily controlled by the surgeon's preference and locked in place.

FACC0167 Wrist Tower

Required Accessory: Order One
CamLoc Clamp
FACC0271

Optional Accessory
FACC355 XS Finger Traps, Limited Reuse
FACC356 S Finger Traps, Limited Reuse
FACC357 M Finger Traps, Limited Reuse
FACC358 L Finger Traps, Limited Reuse
FACC359 XL Finger Traps, Limited Reuse



Surgical Table Accessories



End Rest Procedure Table

Choose Carbon Fiber or Phenolic

- Easy-to-use durable surgical table
- Carbon fiber technology produces incredibly solid components that are completely invisible to x-rays
- Adjusts up or down to be level with the OR table
- End rail accommodates traction attachment and locks to side rail in seconds
- Adjustable leg height with twist handle locking system

Table measures 16"W (41cm) at narrow end and 34"L x 26" (86cm x 66cm) at wider end. Deluxe foam pad included.



Hourglass Procedure Table

Choose Carbon Fiber or Phenolic

- Easy-to-use durable surgical table
- Carbon fiber technology produces incredibly solid components that are completely invisible to x-rays
- Adjusts up or down to be level with the OR table
- End rail accommodates traction attachment and locks to side rail in seconds
- Adjustable leg height with twist handle locking system

Table measures 15"W (38cm) at middle and 32"L x 23"W (84cm x 58cm) at table ends. Deluxe foam pad included.

Ordering Information

End Rest Major Procedure Table

FACC323 End Rest Major Procedure Table, Carbon Fiber
FACC325 End Rest Major Procedure Table, Phenolic
FACC508-0101 Replacement Deluxe Foam Pad

Two Clamps Required for
Either Product: Order Two

Universal Clamp
FACC0012

Deluxe Rail Clamp
FACC0023

Hourglass Major Procedure Table

FACC326 Hourglass Major Procedure Table, Carbon Fiber
FACC320/FACC321 Hourglass Major Procedure Table, Phenolic
FACC508-0106 Replacement Deluxe Foam Pad

Surgical Table Accessories



Major Procedure Table

Choose Carbon Fiber or Phenolic

- Easy-to-use durable surgical table
- Carbon fiber technology produces incredibly solid components that are completely invisible to x-rays
- Adjusts up or down to be level with the OR table
- End rail accommodates traction attachment and locks to side rail in seconds
- Adjustable leg height with twist handle locking system

Table measures 15"W x 34"L (38cm x 86cm).
Deluxe foam pad included.



Minor Procedure Table

Choose Carbon Fiber or Phenolic

- Easy-to-use durable surgical table
- Carbon fiber technology produces incredibly solid components that are completely invisible to x-rays
- Adjusts up or down to be level with the OR table
- Perfect for all arm and hand procedures
- No leg attachment

Table measures 15"W x 30"L (38cm x 76cm).
Deluxe foam pad included.

Ordering Information

Rectangle Major Procedure Table

FACC316 Rectangle Major Procedure Table, Carbon Fiber
FACC310 Rectangle Major Procedure Table, Phenolic
FACC508-0073 Replacement Deluxe Foam Pad

Rectangle Minor Procedure Table

FACC331 Rectangle Minor Procedure Table, Carbon Fiber
FACC330 Rectangle Minor Procedure Table, Phenolic
FACC508-0072 Replacement Deluxe Foam Pad

Two Clamps Required for
Either Product: Order Two

Universal Clamp
FACC0012

Deluxe Rail Clamp
FACC0023

Surgical Table Accessories

Standard Armboard

- Simply place armboard on OR table side rail and it snaps locked tight
- Armboard offers a full range of motion, swings 180°
- Simply pull finger trigger at end of armboard and move to required position. Release trigger and it locks tight. To remove, just pull finger trigger and lift off side rail.

Armboard, Standard
FACC0024

BB2080AP-2D 2" (5cm) Deluxe Pad
BB2080AP-25F 2" (5cm) Softcare Pad



Pad sold separately

Adjustable Height Armboard

- This armboard adjusts vertically to be level with OR table, either with or without X-ray tops
- To adjust armboard vertically, simply place armboard on side rail, loosen handle and raise to correct table height and tighten handle
- Eliminates multiple size pads

Armboard, Adjustable
FACC0026

BB2080AP-2D 2" (5cm) Deluxe Pad
BB2080AP-25F 2" (5cm) Softcare Pad



Pad sold separately

Extra-Wide Armboard

Armboard, Extra-Wide

- 11"W x 26 $\frac{1}{2}$ "L (28cm x 67cm) to offer a bigger surface area when necessary

FACC0027

Armboard, Extra-Wide, Adjustable

- This armboard adjusts vertically to be level with OR table, either with or without X-ray tops

FACC0037

FACC508-0105 2" (5cm) Deluxe Pad
FACC508-0152 2" (5m) Softcare Pad



Pad sold separately

Surgical Table Accessories



Radiolucent Armboard

- Slips under patient's shoulder and provides support during injection of contrast materials for MRI and CT scans or placement of PICC lines
- 2" conductive, vinyl-covered foam pad mounts with an attached sleeve and strap (sold separately)
- Radiolucent, Phenolic and Reusable

FACC0038 Armboard, Radiolucent, 6"W x 3"L

BB2080AP-2D 2" (5cm) Deluxe Pad

BB2080AP-25F 2" (5cm) Softcare Pad



Incline Armboard Pad

- Prevents hyperextension of the forearm
- Fits all 6"W x 26"L (15cm x 66cm) armboards
- Made with pressure-diffusing T-Foam™
- Covered in durable, black, conductive vinyl

FACC0056 Armboard, Incline Pad



Armboard Holder

- Stores two standard surgical table armboards
- Use convenient top shelf for clamps or other accessories
- Attaches to wall with four screws (supplied)

FACC0039 Armboard Holder

Surgical Table Accessories

FACC0100



FHC Spine Frame

- Adjusts intraoperatively to the desired lordosis to get optimal surgical site exposure
- Optional transport dolly available
- Patient weight capacity is 500 lbs (227 kgs)
- Deluxe foam pads included

The FHC Spine Frame provides a stable and convenient platform for spine surgeries such as laminectomies, decompressions, and disc surgery. You can adjust it intraoperatively to the desired lordosis to get optimal surgical site exposure. Tapered adjustable pads provide optimal patient safety and comfort. The FHC Spine Frame has a patient weight capacity of 500 lbs (227 kgs) and is C-arm compatible. It can be used with any OR table, and fits the Jackson Spine Table and Allen Flex Frame as well. Comes with crank handle, disposable head rest, and two arm cradles. Optional dolly is available

FACC0100 Schure Spine Frame

Optional Accessories

FACC508-0373	Disposable Laminectomy Arm Cradles, 12 prs/cs
FACC508-1340	Disposable Richard Slotted Head Rests, Extended, 6/cs
FACC508-0472	FHC Spine Frame Pad Set
FACC0105	FHC Spine Frame Crank Handle
FACC0106	Dolly, FHC Spine Frame

Surgical Table Accessories



TKR Positioner for Total Knee Replacement

- Track Locking Bracket securely locks the Base Plate to the table with two thumb screws
- Locks in any position with a simple turn of the wrist
- Smooth sliding motion for effortless leg positioning
- All components are autoclavable
- CamLoc Clamp sold separately (see below)

Ball joint allows the surgeon to position the operative leg in extension, flexion, tilt and rotation.

FACC0141 TKR Positioner, 24" (61cm)

FACC0171 TKR Positioner, 30" (76cm)

FACC0146 Disposable TKR Boot Liners, Sterile, 12/cs

Required Accessory: Choose One

CamLoc Clamp

FACC0271



Schure Foot for Total Knee Replacement

- This new design offers the same secure support as the stainless steel model without the concerns of radiopacity
- The surgeon can replace the knee while the patient's foot is held firmly in place
- Disposable conductive, non-latex foot pad included
- Now available in radiolucent, clear Lexan®
- Patient's well leg lies flat
- Schure Socket XL sold separately

FACC0133 Schure Foot, Lexan

FACC333 Schure Foot, Stainless Steel

FACC508-0111 Disposable Foot Pads, 12/cs

FACCF-RCP2 Schure Socket XL



Surgical Table Accessories

Arthroscopic Leg Holder

- VELCRO® brand fastener strap wraps completely over leg holder for total stability
- Pressure relief foam pad included
- (2cm) $\frac{5}{8}$ " mounting post
- Schure Socket XL sold separately
- Extremely versatile, easy-to-use and completely rigid.
Spring-loaded braces slide into place and snap lock.

FACC0080 Arthroscopic Leg Holder

FACC508-0103 Disposable Premium Pads, 12/cs

FACCF-RCP2 Schure Socket XL

FACC2250 Well Leg Holder



Schure Grip Leg Holder

- Dual independent braces freely rotate 360° and spread horizontally from 3"-11"W (8cm-28cm) to fit any size leg at any angle
- Twist one brace side down, put the patient's leg on the leg holder, return the brace side back up, slide brace horizontally for a snug fit, and lock in place with convenient twist handle

Use also for ACL procedures. Stainless steel. 12"L x 1 $\frac{1}{2}$ "D (31cm x 4cm) leg support x 8"H (20cm) braces, 16"H x $\frac{5}{8}$ "D (41cm x 1.6cm) mounting post. Schure Socket XL sold separately.

FACC0057 Schure Grip Leg Holder

FACC508-0103 Disposable Premium Pads, 12/cs

FACCF-RCP2 Schure Socket XL



Surgical Table Accessories



Foot Extension

- Mounts vertically as a foot support when using reverse Trendelenburg
- Fits all OR tables and completely radiolucent

Use as a table extension in the horizontal position to lengthen size of OR table. 2" (5cm) Deluxe Pad included.

FACC0022 Foot Extension, 20"W x 10"L
(51cm x 25cm)

Required Simple Clamp: Order Two
FAC0003

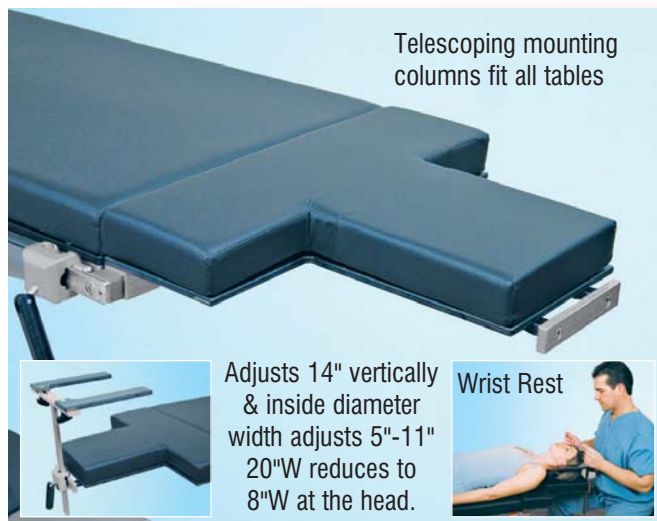

Narrow Head Rest

- Improves surgeon's access at the head of the surgical table during ENT, neurosurgery, plastic surgery or ophthalmic surgery. Use instead of standard head rest.
- Radiolucent head rest includes 2" (5cm) premium pressure management pad. Deluxe pad included.

FACC0062 Narrow Head Rest

Required Simple Clamp: Order Two
FACC0003

Optional Accessory
FACC0067 Wrist Rest

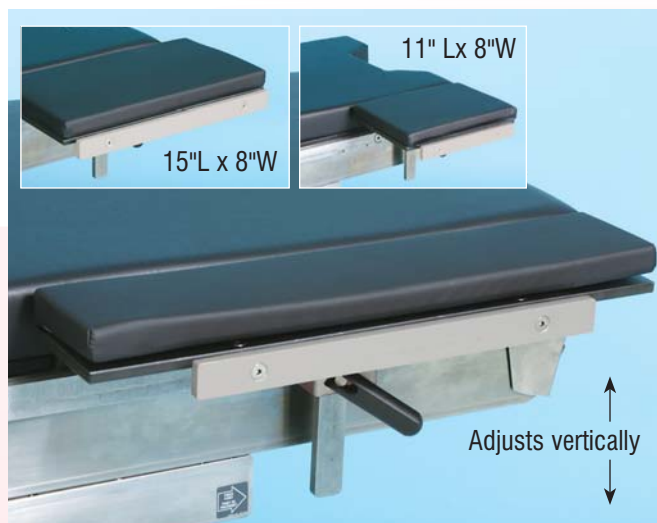

Table Width Extenders

- Attaches to OR side rail with mounting clamp
- Raise or lower height of extender to be level with the OR table, either with or without an x-ray top

Attached side rail allows any table accessory to be mounted. Deluxe pad included.

FACC0077 20"L x 4"W (51cm x 10cm)
FACC0067 15"L x 8"W (38cm x 20cm)
FACC0068 11"L x 8"W (28cm x 20cm)

Required Simple Clamp: Order One
FACC0003

Surgical Table Accessories

Shoulder Supports

- Provides comfortable support for Trendelenburg positioning
- Deluxe pads on a broad support surface with ball and socket adjustments provide optimal positioning for any size patient
- Adjusts vertically to accommodate x-ray tops
- Schure Socket XL sold separately

FACC63500 Shoulder Supports

Required Accessory
FACCF-RCP2 Schure Socket XL



Nissen Straps

- Offers support needed during steep reverse trendelenburg positioning. Attaches to rail quickly and securely.
- 20"L x 5"W x 1" (51cm x 13cm x 3cm) thick pad offers complete support

FACC0111 Nissen Straps, 48"L x 2"W
(19cm x 5 cm)

FACC0118 Bariatric Nissen Straps, 72"L x 2"W
(183cm x 5cm)

Required Simple Clamp: Order Two
FACC0003



Restraint Strap

- Amsco style
- All-rubber conductive strap
- 96"L (244cm) with two airplane-style buckles
- Very durable...easy to clean and disinfect
- Mounts to surgical table with or without hooks

FACC3200 Restraint Strap, No Hooks

FACC3250 Restraint Strap, 2 Hooks

FACC3300 Bariatric Restraint Strap, No Hooks

FACC3350 Bariatric Restraint Strap, w/Hooks



Surgical Table Accessories



Multi-Axis Arm Positioner

- Versatile and comfortable positioning with the new ball socket locking system
- Arm platform measures 6"W x 16"L (15cm x 41cm)
- 2" (5cm) Deluxe Concave Foam Pad included
- (2cm) $\frac{5}{8}$ " Mounting Post

Perfect for seated, lateral, prone, neuro and park bench positions. Schure Socket XL sold separately.

FACC0600 Multi-Axis Arm Positioner

FACCF-RCP2 Schure Socket XL



Lateral Positioners

- Lateral Positioners are simple to set up and offer another alternative for lateral positioning
- Three swivel braces have Deluxe foam pads and rotate over the OR to conform to any size patient, they offer complete stability and ease of use
- (2cm) $\frac{5}{8}$ " stainless steel mounting post
- Schure Socket XL separately

FACC0069 Lateral Positioners

FACCF-RCP2 Schure Socket XL



Lateral Braces

- Secure and comfortable positioning for total hip replacement, and any other procedure requiring total lateral stability
- Three multi-axis braces easily accommodate any size patient for perfect lateral positioning
- Pressure relief foam with Deluxe cover provide extreme protection for the patient
- Schure Socket XL separately

FACC6000 Lateral Braces

FACCF-RCP2 Schure Socket XL

Surgical Table Accessories

Toboggan Arm/Leg Guard

- Available in four sizes: Small through X-Large
- Simply slide under OR table pad to secure arms or legs
- Physician can lean against guards without interfering with anesthesia lines

FACC8001 Small, 6"H x 10"L (15cm x 25cm)

FACC8000 Medium, 8"H x 16"L (20cm x 41cm)

FACC8002 Large, 10 $\frac{1}{2}$ "H x 16"L (27cm x 41cm)

FACC8003 X-Large, 10 $\frac{1}{2}$ "H x 24"L (27cm x 61cm)



Anesthesia Screen

- Adjusts from 15"-33" (38cm x 84cm) in height
- Horizontal adjustment feature facilitates viewing of patient
- Locks with a .25" (.6cm) twist of the handle
- Stainless steel construction
- Schure Socket XL sold separately

FACC0005 Anesthesia Screen

FACCF-RCP2 Schure Socket XL



Winged Anesthesia Screen

- Holds surgical drape
- Can be adjusted to change height or angle
- Made of two anesthesia screens & lengthwise tube
- Composed of stainless steel
- Requires two Clark sockets on either side (sold separately)

FACC0007 Winged Anesthesia Screen

FACC0001 Clark crutch socket



Surgical Table Accessories



Malleable Anesthesia Screen

- Flexible, coated stainless steel tubing
- Easily shaped while retaining its memory,
- Allows for many different draping positions
- Rod ends attach to surgical table with two Clark sockets. (sold separately)

FACC0086 Malleable Anesthesia Screen

FACC0001 Clark crutch socket



Extremity Positioner

- Great for positioning the lower extremity for foot or ankle procedures
- Sealed seams for easy clean-up
- Dimensions: 16"L x 12"W x 7"H (41cm x 31cm x 18cm)

This pad is ideal and used regularly for prepping of the arm or leg surgical site.

FACC0357 Extremity Positioner



Saphenous Vein Harvest Pad

- Holds legs externally rotated and slightly flexed for minimally invasive, bridging or open harvesting procedures
- The cover is a multi-directional stretch cover. Inside consists of a top layer of conforming foam with a firm supportive base. Water-resistant cover is not made with natural rubber latex.
- Sealed watertight seams for easy clean-up

The Saphenous Vein Harvest Pad holds patient's legs at the optimal position for assessment and harvesting of the saphenous veins for coronary bypass surgery.

FACC0356 Saphenous Vein Harvest Pad

Surgical Table Accessories

Well Leg Holder

- Helps prevent nerve damage
- Works on both left and right leg

The foam Well-Leg Holder easily supports with comfort the non-affected, well-leg during arthroscopic knee procedures, fracture repairs and cast procedures.

FACC2250 Well Leg Holder



Universal Prepper

- Supports limbs of all sizes
- Pad removes for easy cleaning

The Universal Prepper safely and effectively holds upper or lower extremities. The unique pivoting design allows for infinite positioning of the extremity. Comes complete with 2" (5cm) thick Deluxe pad. Schure Socket XL sold separately.

FACC0161 Universal Prepper

FACCF-RCP2 Schure Socket XL



Elbow Arthroscopy Support

The Elbow Arthroscopy Support comfortably and securely holds the upper extremity for prepping and during surgical procedures. The unique pivoting design provides flexibility for all patient anatomies. Comes complete with Deluxe pad which can be removed for easy cleaning. Schure Socket XL sold separately.

FACC0168 Elbow Arthroscopy Support

FACCF-RCP2 Schure Socket XL



Surgical Table Accessories



Irrigation Towers

- Can hold up to eight (8), five (5) liter bags
- Wide, inverted, 5-legged base resists tipping...no need for “sand-bagging”
- Adjustable from 5'- 8' (1.5m-2.4m) (9' with custom hangers)
- 2- or 4-channel designs
- Push-down squeeze release handles gives a 2-1 mechanical advantage
- No electric or hydraulic parts that require overnight recharging, heavy maintenance, or seals that leak

Great for fluid-intensive irrigation procedures such as arthroscopic, orthopedic, hysteroscopic, endoscopic, TURP, etc.

FACC0157 Irrigation Tower, 4-Channel

FACC0158 Irrigation Tower, 2-Channel



Safety Draw

- Avoid needle sticks
- Hands-free access to medication vials
- Easy viewing of medication labels
- Helps reduce medication errors

Safety-Draw maintains sterility while allowing access to non-sterile vials. This protects both patient and staff by helping to prevent dangerous medication mix-up, as well as needle sticks.

FACC0076 Safety Draw, IV Pole Mount

FACC0082 Safety Draw, Mayo Stand Mount

Surgical Table Accessories

Malleable Hand Positioner

- Case of 5
- Made with aluminum
- Perfect for micro nerve reconstruction procedures
- Can withstand more than 20 articulations
- Two sizes available
- Fits almost any surgical patient
- Autoclavable
- Radiolucent

FACCA20900 Malleable Hand Positioner



Equalizing Device

- Provides equal traction to all 5 fingers
- Used w/ Mesh Finger Traps or S/S Finger Traps
- Autoclavable

FACCR734-05 Equalizing Device



Mesh Finger Traps

- Latex-free
- Double-sleeved soft mesh material
- Firmly grips fingers & hands to provide a comfortable, custom fit to each traction procedure
- Can be purchased sterile or non-sterile

FACC355 - XS
FACC356 - S
FACC357 - M
FACC358 - L
FACC359 - XL



Surgical Table Accessories



Schlein Hand Positioner

- Supports multiple positions
- Innovative cleat system can be used with or without weights
- Autoclavable

FACCA20750 Schlein Hand Positioner



FHC1000 Orthopedic Extension

- Complete set of orthopedic accessories for use with the FHC1000 series
- Carbon fiber abductor bars rested on cart during insertion onto side rails of seat section
- Includes full range of accessories for lower limb traction

FACC0061 FHC1000 Orthopedic Extension

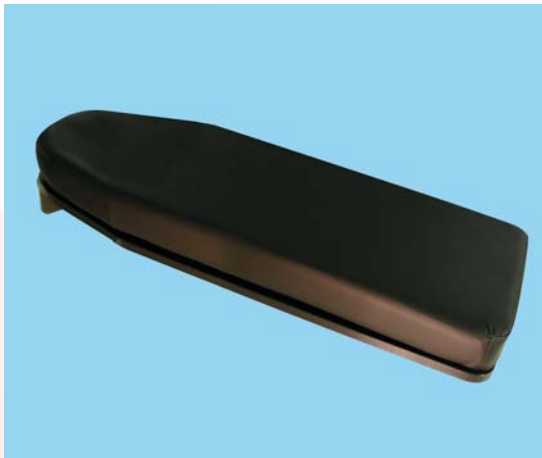

Wide Armboard

- Includes 2" pad
- Measures: 11"W x 26"L
- Rotates 180°
- 21 locking increments
- Compatible with 1,2,3 & 4" pads
- Fits all major surgical tables

FACC4410 Wide Armboard

Surgical Table Accessories

Horseshoe Headrest

- Includes traction bar
- Connects to surgical table using multi-positioning base & swivel adapter
- Support prone or supine positioning
- Easily adjusted for various patient head sizes
- Includes swivel adapter (FACC0101)
- Gel pads can be removed to leave unit for efficient cleaning (autoclavable)
- Compatible with the FHC1000 series surgical tables

FACC0103 Horseshoe Headrest w/ Traction Bar



Lateral Support

- Attaches anywhere along side rails
- Provides patient with lateral support
- Includes 2 adjustable joint to fit patient size & position
- Made of stainless steel and integrated polyurethane foam pad
- Requires a side rail lock to be secured

FACC0015 Lateral Support

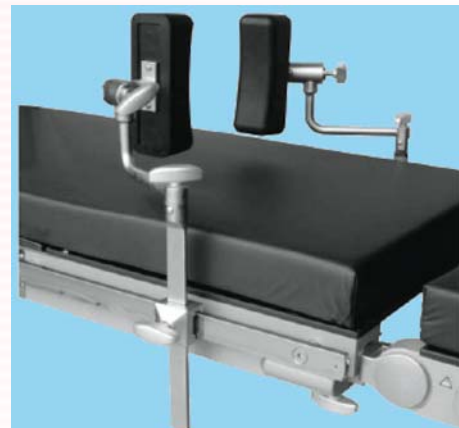

Cassette Top for FHC1000 Series

- Attaches to top of O.R. table
- Allows convenient lateral insertion of x-ray cassettes

FACC0046 Cassette Top for FHC1000 Series Surgical Table

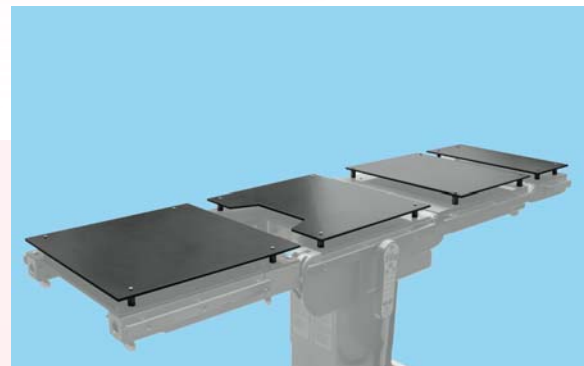

Surgical Table Accessories



Alero Deluxe Armboard Restraint Strap

- Two part strap w/ double velcro closures
- Attaches to arm board for easy use
- Upper strap - 26"L x 2"W
- Lower strap - secures around 6" boards

FACC4000 Alero Deluxe Armboard Restraint Strap



Deluxe Two-Piece Vinyl/Velcro Restraint Strap

- 4" wide
- Secures to side rails
- No hooks required
- Extends 30" to 70"

FACC3400 Deluxe Two-Piece Vinyl/Velcro Restraint Strap



Counter-Traction Strap

- Supports patient while being manipulated during surgery
- Attaches to surgical table using clarke socket (FACC0001 - sold separately)

FACC0079 Counter-Traction Strap

Surgical Table Accessories

Universal Well Leg Support

- Solid stainless steel adjustable extension bar
- Boot clamp is designed for full-range positioning
- Ideal for positioning patients of any height
- Comes with 1 Restraint Strap & 1 Pressure Management Pad
- Requires one Super clamp or clark socket for mounting to surgical table (sold separately)

FACC6610 Universal Well Leg Support (1ea.)

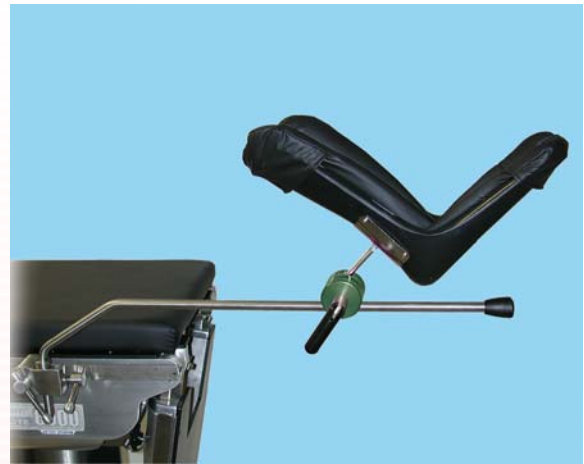

Picket Fence Leg Prep

- Efficiently preps both legs at once
- Stainless steel support bar - 5/8" diameter
- Height adjusts up to 30"
- Attaches to surgical table using a clark socket or Super clamp (sold separately)
- Easy positioning
- Easy cleaning

FACC4200 Picket Fence Leg Prep

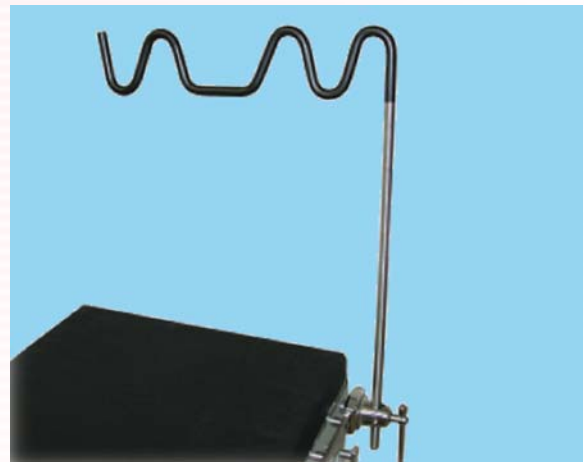

Leg Prepper

- Padded horseshoe cradle holds patient's leg comfortably during the prepping procedure
- Stainless steel 30"H x 5/8"D (76cm x 2cm) mounting post rotates, rises, and lowers easily to various prepping positions
- Schure Socket XL sold separately

FACC4800 Leg Prepper

FACC508-0107 Replacement Pad
FACCF-RCP2 Schure Socket XL



Surgical Table Accessories



Bi-Lateral Leg Prepper

- 500 lb (227 kg) patient weight capacity
- Pads remove for easy cleaning

The Bi-Lateral Leg Prepper safely and effectively holds both legs for bi-lateral preps. The unique rotating/pivoting design of the holders allow for infinite positioning off the extremity. Includes 2" (5cm) Deluxe Pads. Schure Socket XL sold separately.

FACC0236 Bi-Lateral Leg Prepper

FACCF-RCP2 Schure Socket XL

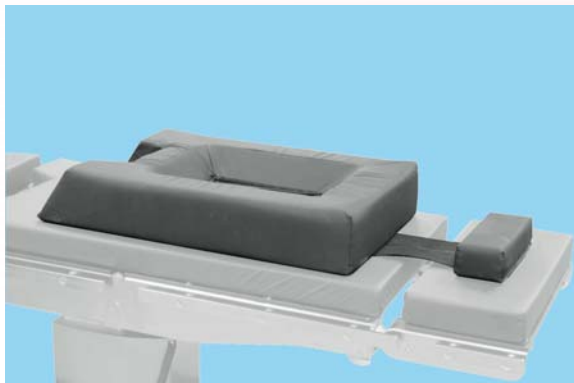

Dorsal Cushion

- Provides support during intravertebral disk operations
- Antibacterial
- Antistatic
- Flame-retardant
- Memory foam pad relieves pressure and prevents bedsores

FACC0028 Dorsal Cushion



Accessory Cart

- Stainless steel construction
- Rest on four swivel casters for easy movement
- Three stainless steel shelves
- Provides ample space for accessory storage
- Built-in clamps aid attachment of orthopedic abductor bars

FACC0063 Accessory Cart

Surgical Table Accessories

Plastic Drain Pan

- Collects liquid drainage during urological & gynecological procedures
- Attaches to bottom of either FHC1000 seat section or FACC0040 I.A. Extender

FACC0032 Plastic Drain Pan

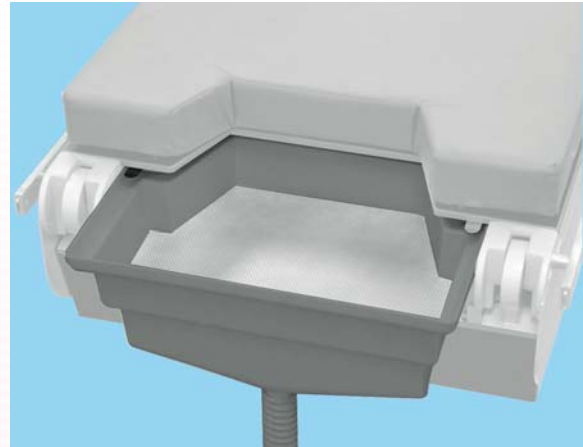

Deep Plastic Drain Pan

- Collects liquid drainage during urological & gynecological procedures
- Attaches to bottom of either FHC1000 seat section or FACC0040 I.A. Extender

FACC0033 Deep Plastic Drain Pan



Stainless Steel Drain Pan

- Collects liquid drainage during urological & gynecological procedures
- Attaches to bottom of either FHC1000 seat section or FACC0040 I.A. Extender

FACC0034 Stainless Steel Drain Pan



Surgical Table Accessories



Patient Roller

- Assists with patient transfers
- Eliminates physical lifting of patients

Size Options:

FACC0123 - Patient Roller 25"L x 15"W

FACC0125 - Patient Roller 30"L X 15"W

FACC0126 - Patient Roller 30"L X 15"W

FACC0130 - Patient Roller 67"L x 15"W



Stainless Steel Roller Board Holder

- Mounts easily on wall or door for convenient storage
- Fits roller boards made by almost all manufacturers

FACC0132 - Stainless Steel Roller Board Holder

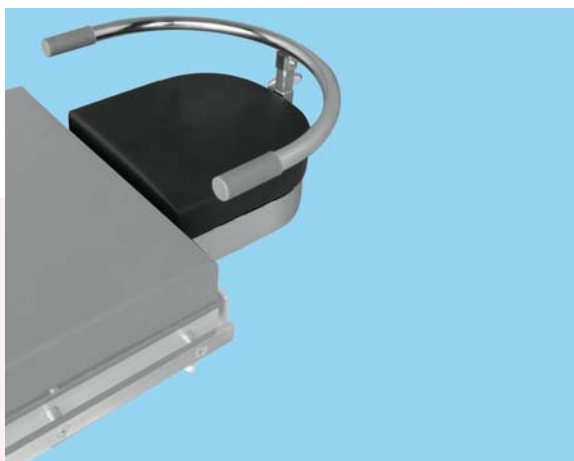

Ophthalmic Headrest with Surgeon Wrist Support

- Provides surgeon with full access to the facial region
- Wrist support bar helps prevent fatigue
- Comes with antibacterial, antistatic, flame-retardant pad
- Made with memory-foam to relieve pressure and prevent bedsores
- Has two bars used for insertion into the FHC1000 back section
- Structure is composed of stainless steel

FACC0036 Ophthalmic Headrest with Surgeon Wrist Support

Surgical Table Accessories

ENT Headrest

- Constructed specifically for ENT procedures
- 2" thick pad
- Attaches to FHC1000 surgical table

FACC0062 ENT Headrest



Adjustable Headrest Adapter

- Provides adjustable insertion points for DORO® and other neurosurgery headsets
- Installed onto the back section, in both normal and reverse orientation
- Composed of stainless steel

FACC0035 Adjustable Headrest Adapter



Uro Extender

- Useful in urology and procedures which require ample IA coverage
- In normal orientation it can be attached to the seat section
- Reverse orientation it can be attached to the back section
- Includes a perineal cutout, and 2 ½ in (6.3 cm) thick pad
- Has insertion points which are identical to those of the table
- Made with radiolucent phenolic board

FACC0040 Uro Extender

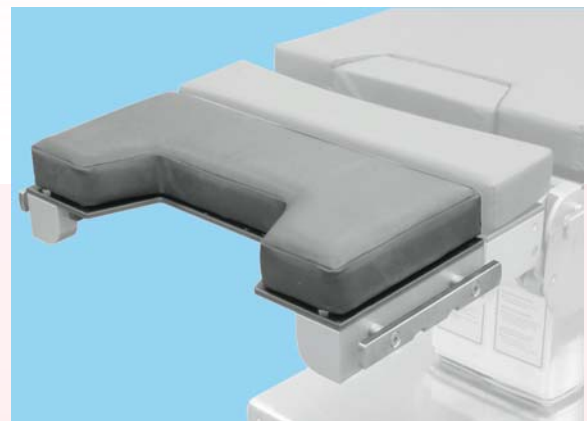

Surgical Table Accessories



Long Table Width Extender

- For use with bariatric patients
- Extends the width of the table top by 4" (45 cm long)
- Attaches to the back, seat or leg section using an integrated clamp
- Comes with antibacterial, antistatic, flame-retardant pad
- Made with memory-foam to relieve pressure and prevent bedsores.

FACC405 Long Table Width Extender

FACC404 Replacement pad



Foot Controller

- Provides surgeon with the capability to move the table when using the hand pendant is inconvenient.
- Communicates with 3 meter long cord
- Used to control height, Trendelenburg, reverse Trendelenburg & lateral tilt functions
- Foot controller meets fluid ingress protection of IPX-7

FACC0045 Foot Controller



Infusion Stand

- Fastened to the side rail using a Clark socket
- Height and angle can be adjusted manually
- Composed of stainless steel & plastic

FACC0008 Infusion Stand

Surgical Table Accessories

Morgan Pelvic Rest

- Support bar covered in cylindrical pad
- Provides pelvic support during rectal procedures
- Comes with antibacterial, antistatic, flame-retardant pad
- Made with memory foam to relieve pressure and prevent bed-sores
- Attaches to the surgical table side rails using two Clark Sockets
- Structure is composed of stainless steel

FACC0029 Morgan Pelvic Rest

FCP001559 Replacement pad



Horizontal Traction Tower

- Solid stainless steel construction
- Adapts easily to end of most arm & hand tables
- 3/4" outside diameter
- Square tube with 1/2" telescoping tube
- Comes complete with all necessary hardware

FACC344 18" long for rectangular-shaped table

FACC345 24" long for hourglass-shaped table



Radiolucent Armboard w/ Enhanced Post-Loc Rail Mounting System

- Built-in mounting mechanism allows for easy vertical up & down movement
- Adjusts to level for O.R. table surface without changing arm board pad
- Easy 180° rotation when mounted on either side of O.R. table
- Secure positive locking mechanism for safe & easy fit to any O.R. table rail
- Lever-free arm board provides no interface during C-arm imaging and x-ray procedures
- Measurements: 6"W x 26" L

FACC0401 Radiolucent Armboard w/ Enhanced Post-Loc Rail Mounting System



Surgical Table Accessories



Arthroscopic Stress Post

- Provides fulcrum to leverage the leg for better knee access
- 5/8" diameter
- Height adjustable post
- Includes: 4" x 6" pad
- Stainless steel plate & support bar
- Available in 12" or 18" post height
- Securely attaches to any O.R. table using Clark socket

FACC9050-12 Arthroscopic Stress Post w/ 12" Height
FACC9050-18 Arthroscopic Stress Post w/ 18" Height



Transfer Board

- Helps attach accessories with flat bar sizes 1/4" x 1"
- Tightened using a thumb screw
- Composed of stainless steel

FACC0041 Transfer Board

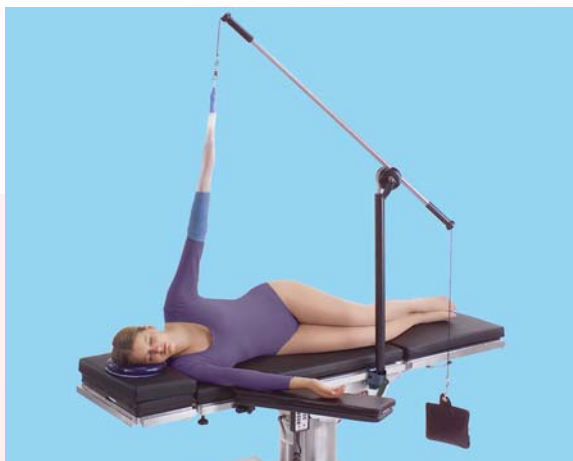

Arm Traction Device

- Accommodates intraoperative traction up to 40 lbs for shoulder, arm, and wrists procedures
- Mechanical safety stop prevents patient injury
- Saves time by using arm support for prep and traction

FACC20500 Arm Traction Device

Surgical Table Accessories

Duraclear Arm & Hand Tables

- Provides excellent X-ray clarity
- C-Arm visualization
- 3 sizes available
- Comes with 1" standard pad
- Requires 2 clark sockets or round bar clamps (for mounting)
- Fits all North American surgical tables

FACC1200 12"x30" Duraclear™ Table w/ Pad

FACC1600 16"x30" Duraclear™ Table w/ Pad

FACC1800 18"x30" Duraclear™ Table w/ Pad

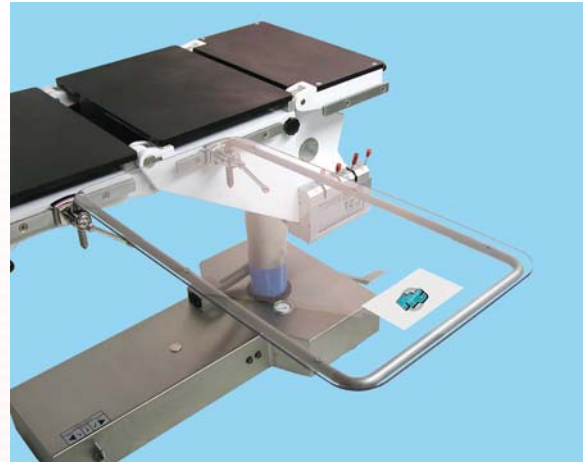

LPS Arm Support

- Provides comfortable & convenient placement of non-operative arm
- Easy access to patient I.V.
- Enhanced stabilization of shoulder
- Attaches to the surgical table using a Clark Socket

FACC0078 LPS Arm Support



Under Pad Mount Arm & Hand Tables

- Very durable table
- Offers poly carbonate covered opening (14"W x 24"L) for C-arm access
- Rugged stainless steel construction
- Designed to slip under pad
- Convenient handle to carry/store table easily
- Optional Add-A-Rail easily added to end of board for multiple accessories

FACC341 Under Pad Mount Arm & Hand Tables

FACCM312 - replacement 2" thick pad only



Surgical Table Accessories

Kross Arm Support

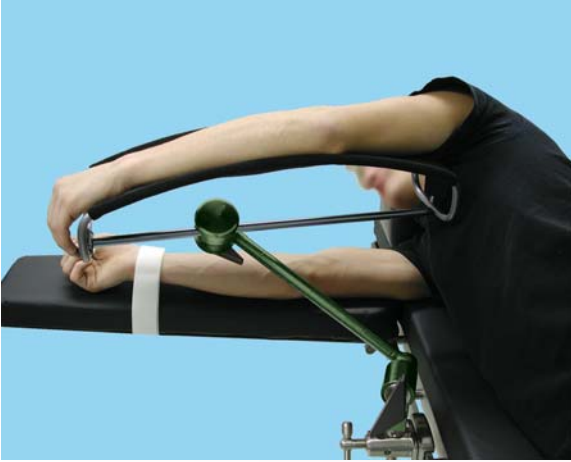

- Perfect for arm chair, prone, lateral, & neuro procedure positioning
- SS arm cradle measures 6" x 20"
- Disposable Kross Kloth sleeve
- Includes: 1 roll
- Requires: 1 Clark Socket for mounting (sold separately)

FACC7500 Kross Arm Support

FACC7520 - Disposable Kross Kloth

Split Leg Section For FHC1000 O.R. Tables

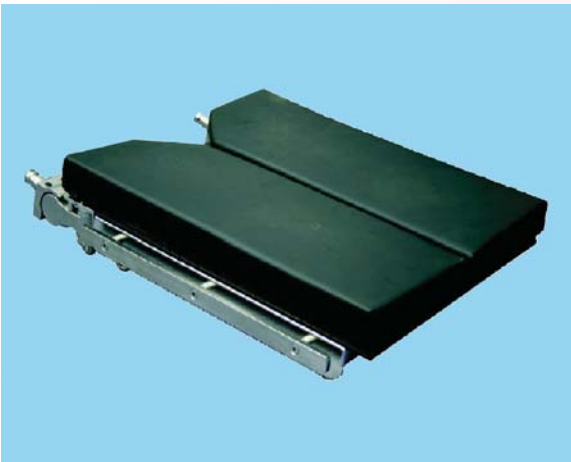

- Manually operated
- Can be raised 30°, lowered 90°, & opened 180°
- Each leg plate includes it's own antibacterial, antistatic, flame retardant memory-foam mattress pad
- Weight capacity of 800 lbs.

FACC0092 Split Leg Section For FHC1000 O.R. Tables

Add-A-Rail



- Solid stainless steel
- Mounts to block underneath table w/ 2 counter sunk screws
- Allows you to adapt multiple accessories at one time

FACC314 18" long for rectangle-shaped table
FACC324 24" long for hourglass-shaped table

Surgical Table Accessories

FHC Strap VELCRO® Rolls

FHC Strap is the answer to your taping, strapping, tie-down and restraining requirements. It has VELCRO® brand fastener hook and loop back-to-back on 30' (9 meters) rolls and available in 4 widths. No sticky tape residue to damage equipment. Soft edge design to protect patient's skin. Not made with natural rubber latex.

FACC0147	3/4"W (2cm)
FACC0148	1 1/2"W (4cm)
FACC0149	3"W (8cm)
FACC0150	5"W (13cm)



A-Line Positioner w/Straps

A-Line Positioner w/Straps consist of two exclusive 1"W x 17"L (3cm x 43cm) soft edge straps which reduce the risk against skin ulceration. This anatomically formed base provides the best angle while keeping the skin taut for optimal needle insertion.

FACC0143	Disposable A-Line Positioner w/Straps, 12/cs
----------	--



A-Line Positioners

- Stable and accurate positioning
- Enhanced comfort for the patient
- No need to try to find a make-shift positioner
- Has slot to secure to armboard

Disposable support positioner to provide for a fast, consistent and reliable A-Line insertion.

FACC0144	Disposable A-Line Positioners, 30/cs
----------	--------------------------------------



Surgical Table Accessories



Comfort Mat

The 20" x 33" (51cm x 84cm) Comfort Mat is ideal at scrub sinks, nurse's stations or at OR tables. Helps reduce fatigue, pain and discomfort associated with standing for long periods of time.

- Absorbent-resistant closed-cell foam
- Beveled, low-profile edges
- Non-slip surface is chemical resistant
- Custom sizes are available

FACC0145 Comfort Mat



Schure Slide,
Full-Size



Schure Slide, Ergo



Schure Slide,
Anti-Static

SCHURE SLIDE
patient transfer system

Schure Slide is smooth surfaced, flexible, and extremely durable. After being placed under a patient, personnel can effortlessly slide the patient from one gurney or table to another. The Full-Size Schure Slide enables personnel to easily slide the patient from one bed to another. Choose Flexible or Rigid. Patented.

- Reduce back injuries and increase comfort
- Non-disposable, no need to waste red bags
- Won't stain—spray and wipe clean
- Speed up turnover time—hang Schure Slide in every OR
- Radiolucent & not made w/ natural rubber latex

ORDERING INFORMATION

FACC2200	Schure Slide, XL, 33"L x 22"W x 1/16"
FACC2201	Schure Slide, Rigid, 33"L x 22"W x 3/16"
FACC2202	Schure Slide, Ergo, 33"L x 23"W x 1/16" 1/16"
FACC2203	Schure Slide, Anti-Static, Black, 33"L x 22"W x 1/16"
FACC2204	Schure Slide, Anti-Static Rigid, Black, 33"L x 22"W x 3/16"
FACC2205	Schure Slide, Full Size, 72"L x 22"W x 3/16"
FACC2206	Schure Slide, Full Size, Anti-Static, Black, 72"L x 22"W x 3/16"
FACC2207	Schure Slide, XLT, 72"L x 22"W x 3/16"

Surgical Table Accessories

800 lb. (363 kg)
Patient Wt. Capacity



Patented

Schure Socket XL

- Hardened clamping surface creates maximum clamping force stopping movement of all accessories
- Attaches along the side rail, without the need of notches

Accepts any round mounting posts up to $\frac{5}{8}$ "D (1.6cm) and rectangular mounting posts up to $1" \times \frac{3}{8}"$ (2.5cm x .95cm). Quickly and easily connects and disconnects securely with a quick turn anywhere along the side rail, even over side rail stand off.

Schure Socket XL
FACCF-RCP2

800 lb. (363 kg)
Patient Wt. Capacity



SpringLoc Clamp

- Securely locks accessories with a flat $1" \times \frac{1}{4}"$ (2.5cm x .6cm) mounting post
- Attaches along the side rail, without the need of notches
- Quick & easy pull-to-release lever

FACC0011 SpringLoc Clamp

800 lb. (363 kg)
Patient Wt. Capacity



CamLoc Clamp

- It can attach to the rail at any location over multiple drapes and accepts accessories with round posts up to $\frac{5}{8}$ "D (1.6cm) and flat posts $1" \times \frac{3}{8}"$ (2.5cm x .95cm)
- Attaches along the side rail, without the need of notches

The CamLoc Clamp is fully autoclavable and is designed for use in the sterile field.

CamLoc Clamp
FACC0271

Surgical Table Accessories

Schure Socket

- Fits round mounting posts up to $\frac{5}{8}$ "D (2cm)
- Locks securely with a twist of the ergonomic handle
- Attaches along the side rail, without the need of notches

The industrial strength Schure Socket fits all OR tables with standard $\frac{3}{8}$ "W x $1\frac{1}{8}$ "H (.95cm x 2.85cm) side rails.

FACC0084



800 lb. (363 kg)
Patient Wt. Capacity

Patented

Universal Rail Clamp

- Spring-loaded and attaches to OR table side rail anywhere along the rail
- Accessories can be mounted vertically or horizontally
- Locks securely with a twist of the ergonomic handle

Accepts both $\frac{5}{8}$ "D (1.6cm) and $1" \times \frac{3}{8}"$ (2.5cm x .95cm) flat bar mounting posts.

FACC0012 Universal Rail Clamp



350 lb. (158 kg)
Patient Wt. Capacity

Patented

Simple Clamp

- Attaches at OR table rail ends or notches
- Accessories can be mounted vertically or horizontally

Securely locks all accessories with flat $1" \times \frac{3}{8}"$ (2.5cm x .95cm) mounting blades anywhere along the table side rail.

FACC0003

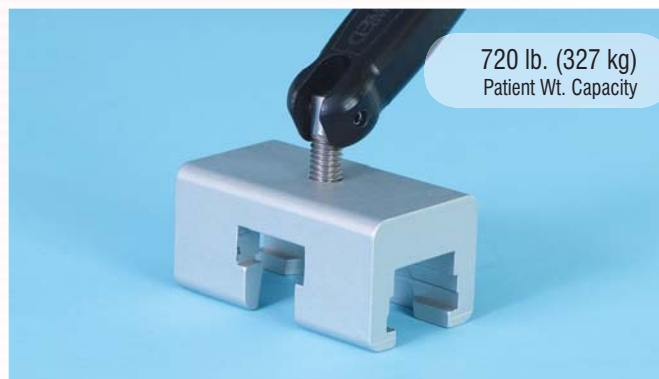

720 lb. (327 kg)
Patient Wt. Capacity

Deluxe Rail Clamp

- Attaches at OR table rail ends or notches
- Accessories can be mounted vertically or horizontally

Securely locks all accessories with $1" \times \frac{3}{8}"$ (2.5cm x .95cm) flat mounting post and round mounting posts up to $\frac{5}{8}$ "D (1.6cm) mounting blades anywhere along the table side rail.

FACC0023

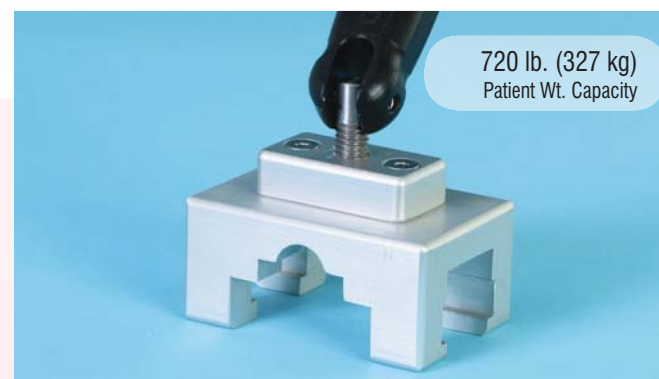

720 lb. (327 kg)
Patient Wt. Capacity

Surgical Table Accessories



Clarke Crutch Socket

- Hardened clamping surface creates maximum clamping force stopping movement of all accessories
- Attaches along the side rail, without the need of notches

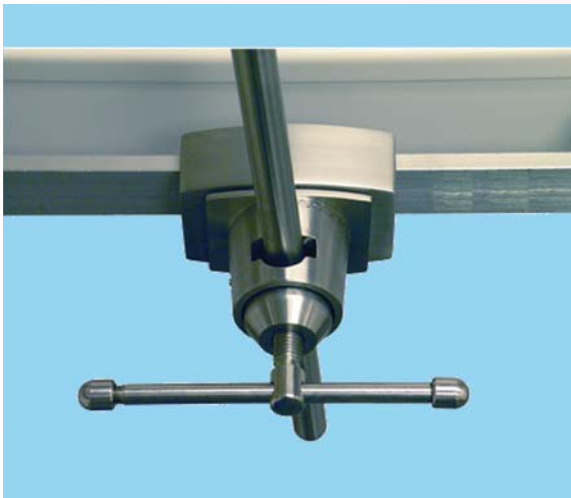

Ultra Clarke Socket

- Securely locks accessories with a flat 1" x 1/4" (2.5cm x .6cm) mounting post
- Attaches along the side rail, without the need of notches
- Quick & easy pull-to-release lever

FACC0011 SpringLoc Clamp



Straight Bar Accessory Clamp

- Solid stainless steel construction
- Accommodates all rectangle bar accessories up to 1/4" x 1"
- Easily attaches to side rails of all North American surgical tables

FACC0004 Straight Bar Accessory Clamp

Surgical Table Accessories

Tri-Clamp

- Designed to provide flexibility
- 3 individual adjustments for lithotomy, abduction & rail securing
- Attaches anywhere on operating table rail
- Patient weight capacity of 350 lbs.
- Used for rectangular blades & round posts

FACCF-TCP2 Tri-Clamp



Simple Clamp

- Innovative design allows placement under/over drapes
- Durable aluminum & stainless steel construction
- Holds all 1/2" to 5/8" (1.3cm - 1.6cm) diameter accessories
- Patient weight capacity of 500 lbs.
- Attaches anywhere on table rail between standoffs

FACC40018 Simple Clamp



Super Clamp

- Multi-positioner clamp
- Solid stainless steel construction
- Effortlessly secures most accessories to siderail of any North American surgical table
- Fits round bars up to 3/4" diameter, straight bars up to 1/4" x 1"
- Accommodates square bar accessories up to 3/4" square

CUCL-7500 Super Clamp



Surgical Table Accessories

FHC offers a full range of armboard surfaces for any type of armboard in both flat and contoured styles to increase patient arm stability. The Softcare and Softcare w/ Gel Surfaces are design to reduce pressure and should be part of your pressure management strategy.

6"
(15cm)



Fits most standard armboard sizes

(Getinge, Maquet, Champaine, Amsco, Berchtold, Steris, Skytron)

	STANDARD		
	2" Pad (5cm)	3" Pad (8cm)	4" Pad (10cm)
FLAT SURFACE	BB2080AP-2	BB2080AP-3	BB2080AP-4

	DELUXE			DELUXE GEL			
	2" Pad (5cm)	3" Pad (8cm)	4" Pad (10cm)	2.25" Pad (6cm)	3.25" Pad (8cm)	4.25" Pad (11cm)	5.25" Pad (13cm)
FLAT SURFACE	BB2080AP-2D	BB2080AP-3D	BB2080AP-4D	BB2080AP-2DG	BB2080AP-3DG	BB2080AP-4DG	BB2080AP-5DG

	SOFTCARE				SOFTCARE W/ GEL			
	2" Pad (5cm)	3" Pad (8cm)	4" Pad (10cm)	5" Pad (13cm)	2.25" Pad (6cm)	3.25" Pad (8cm)	4.25" Pad (11cm)	5.25" Pad (13cm)
FLAT SURFACE	BB2080AP-DSF	BB2080AP-3SF	BB2080AP-4SF	BB2080AP-5SF	BB2080AP-2SFG	BB2080AP-3SFG	BB2080AP-4SFG	BB2080AP-5SFG

	STANDARD		
	2" Pad (5cm)	3" Pad (8cm)	4" Pad (10cm)
CONTOURED SURFACE	BB2080AP-2C	BB2080AP-3C	BB2080AP-4C

	DELUXE			DELUXE GEL			
	2" Pad (5cm)	3" Pad (8cm)	4" Pad (10cm)	2.25" Pad (6cm)	3.25" Pad (8cm)	4.25" Pad (11cm)	5.25" Pad (13cm)
CONTOURED SURFACE	BB2080AP-2DC	BB2080AP-3DC	BB2080AP-4DC	BB2080AP-2DGC	BB2080AP-3DGC	BB2080AP-4DGC	BB2080AP-5DGC

	SOFTCARE				SOFTCARE W/ GEL			
	2" Pad (5cm)	3" Pad (8cm)	4" Pad (10cm)	5" Pad (13cm)	2.25" Pad (6cm)	3.25" Pad (8cm)	4.25" Pad (4.25)	5.25" Pad (13cm)
CONTOURED SURFACE	BB2080AP-2SFC	BB2080AP-3SFC	BB2080AP-4SFC	BB2080AP-5SFC	BB2080AP-2SFGC	BB2080AP-3SFGC	BB2080AP-4SFGC	BB2080AP-5SFGC

*This Page
Intentionally
Left Blank*

Patient Handling

**Reduces
Chance of Cross-
Contamination**

Slip-Resistant

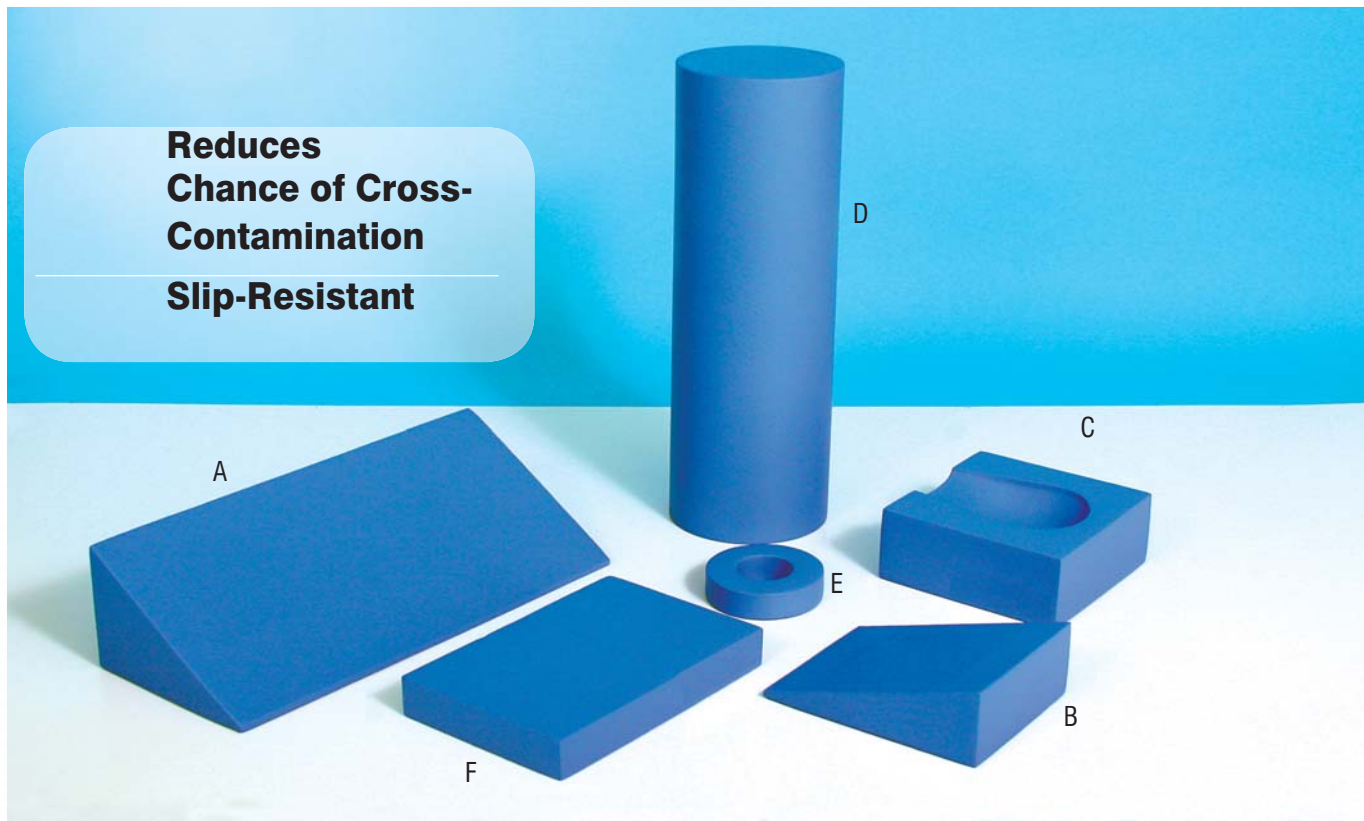

Coated Positioning Pads

Reusable antimicrobial coated positioners ideal for extremity positioning. The positioners are radiolucent and the coating is impregnated with Agion antimicrobial ionic silver that inhibits the growth of bacteria.

Item #	Description	Dimensions
A. FACC508-0355	Double Angle Wedge, 35°/55°	24"L x 9 ³ / ₄ "W x 6 ³ / ₄ "H (61cm x 25cm x 17cm)
FACC508-0356	Angle Wedge, 45°	24"L x 7"W x 7"H (61cm x 18cm x 18cm)
FACC508-0357	Wedge, 15°	10 ¹ / ₂ "L x 9 ³ / ₄ "W x 2 ³ / ₄ "H (27cm x 25cm x 7cm)
B. FACC508-0358	Double Angle, 55°/35°	14"L x 9 ¹ / ₂ "W x 6 ¹ / ₂ "H (36cm x 24cm x 17cm)
FACC508-0359	Wedge, 20°	11"L x 8 ¹ / ₂ "W x 3 ³ / ₄ "H (28cm x 22cm x 10cm)
FACC508-0360	Head & Neck	10 ³ / ₄ "L x 7"W x 6"H (27cm x 18cm x 15cm)
C. FACC508-0361	Head Support, Occipital Adult	10"L x 10"W x 4"H (25cm x 25cm x 10cm)
D. FACC508-0364	Semicircle	14"L x 8 ¹ / ₂ "W x 4 ¹ / ₂ "H (36cm x 22cm x 11cm)
FACC508-0365	Rolls, Small	24"L x 6"D (61cm x 15cm)
FACC508-0366	Rolls, Large	24"L x 8"D (61cm x 20cm)
E. FACC508-0367	Donut, Large, 6 pk.	9"D x 1 ¹ / ₂ "H (23cm x 4cm)
FACC508-0368	Donut, Small, 6 pk.	6"D x 1 ¹ / ₂ "H (15cm x 4cm)
F. FACC508-0362	Rectangular, Large	14"L x 9 ¹ / ₄ "W x 2"H (36cm x 24cm x 5cm)
FACC508-0363	Rectangular, Small	9 ¹ / ₂ "L x 7"W x 2"H (24cm x 18cm x 5cm)

Patient Handling

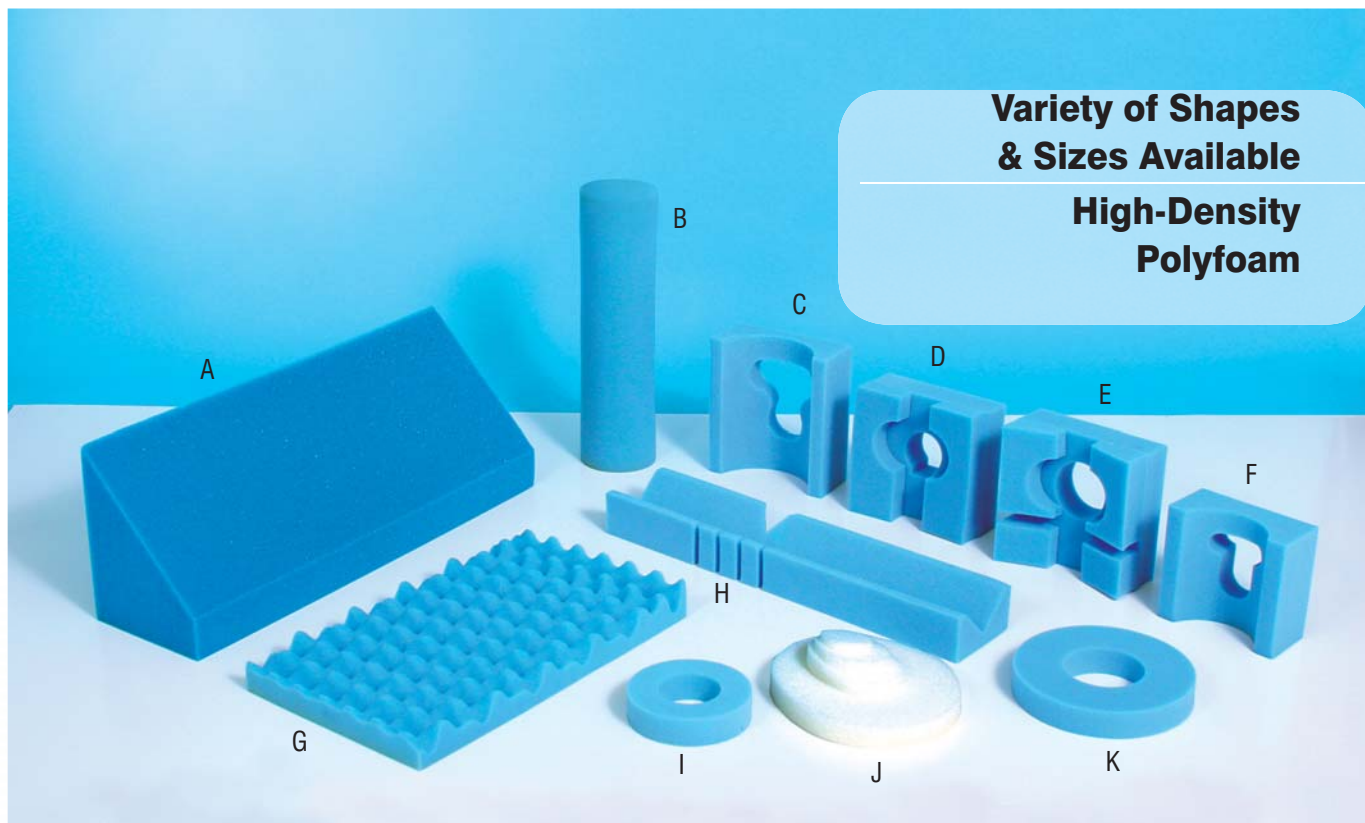

Disposable Positioning Pads

These high-density Polyfoam positioning pads are supportive, comfortable and economical for all your positioning requirements. Available in a variety of shapes and sizes. Custom sizes available. Please call for a quote.

Item #	Description	Dimensions
A	FACC508-0369 Disposable, Wedge	24"L x 9 ³ / ₄ "W x 6 ³ / ₄ "H (61cm x 25cm x 17cm)
	FACC508-0386 Disposable, Wedge	24"L x 7"W x 7"H (61cm x 18cm x 18cm)
	FACC508-0387 Disposable, Body Aligner, Wedge	28"L x 8"W x 10"H (71cm x 20cm x 25cm)
	FACC508-0388 Disposable, Body Aligner, Half Wedge	14"L x 8"W x 10"H (36cm x 20cm x 25cm)
B	FACC508-0379 Disposable, Chest Roll, 12/cs	5"D x 17"L (13cm x 43cm)
C	FACC508-0381 Disposable, Adult Head Support, 12/cs	9"L x 8"W x 3 ¹ / ₂ "H (23cm x 20cm x 9cm)
D	FACC508-0374 Disposable, Richards Head Rest, 6/cs	8 ¹ / ₂ "L x 8"W x 3 ³ / ₄ "H (22cm x 20cm x 10cm)
E	FACC508-0375 Disposable, Richards Slotted Head Rest, 6/cs	8 ¹ / ₂ "L x 8"W x 3 ³ / ₄ "H (22cm x 20cm x 10cm)
F	FACC508-0382 Disposable, Pediatric Head Support, 24/cs	6 ¹ / ₂ "L x 7"W x 3 ¹ / ₄ "H (17cm x 18cm x 8cm)
G	FACC508-0380 Disposable, Convuluted Sheet, 12/cs	20"L x 12"W x 2"H (51cm x 31cm x 5cm)
H	FACC508-0373 Disposable, Laminectomy Arm Cradles, 12 pr/cs	5"W x 24"L x 3"H (13cm x 61cm x 8cm)
I	FACC508-0371 Disposable, Small Donut, 36/cs	1 ¹ / ₂ "H x 6"D (4cm x 15cm)
J	FACC508-0372 Disposable, Super Donut, 36/cs	9"W x 10"L x 1"H (23cm x 25cm x 3cm)
K	FACC508-0370 Disposable, Large Donut, 24/cs	1 ¹ / ₂ "H x 9"D (4cm x 23cm)

Patient Handling



**Reusable, E-Z
clean patient
positioners**

Gel Head Positioners

1 **Gel Donut**

- FACC508-0431 Adult
3" I.D x 8" O.D x 2" (8cm x 20cm x 5cm)
- FACC508-0432 Tall Adult
3" I.D x 8" O.D x 3" (8cm x 20cm x 8cm)
- FACC508-0446 Pediatric
2¹/₄" I.D x 5¹/₂" O.D x 1¹/₄"
(8cm x 20cm x 8cm)
- FACC508-0478 Neonatal
1¹/₂" I.D x 3¹/₂" O.D x 3³/₄"
(4cm x 9cm x 2cm)

2 **Gel Horseshoe**

- FACC508-0443 Adult
3" I.D x 8" O.D x 2" (8cm x 20cm x 5cm)
- FACC508-0444 Tall Adult
3" I.D x 8" O.D x 3" (8cm x 20cm x 8cm)
- FACC508-0447 Pediatric
2¹/₄" I.D x 5¹/₂" O.D x 1¹/₄"
(6cm x 14cm x 3cm)
- FACC508-0479 Neonatal
1¹/₂" I.D x 3¹/₂" O.D x 3³/₄"
(4cm x 9cm x 2cm)

3 **Gel Head Pad w/Center Dish**

- FACC508-0470 Lateral
10" x 9" x 1" (25cm x 23cm x 3cm)
- FACC508-0473 Supine
10" x 9" x 2" (25cm x 23cm x 5cm)
- FACC508-0486 Pediatric Supine
7" x 6" x 2" (18cm x 15cm x 5cm)
- FACC508-0487 Pediatric Lateral
7" x 6" x 1" (18cm x 15cm x 3cm)

- FACC508-0488 Neonatal Supine
5" x 4" x 2" (13cm x 10cm x 5cm)

- FACC508-0489 Neonatal Lateral
5" x 4" x 1" (13cm x 10cm x 3cm)

Gel Head Rest

- FACC508-0520 Contoured
7" x 7" x 3¹/₄" (18cm x 18cm x 8cm)
- FACC508-0532 Ophthalmic
12" x 10" x 3⁷/₈" (31cm x 25cm x 10cm)

4 **Gel Richard Type Headrest**

- FACC508-0462 T Shape
9" x 8" x 4" (23cm x 20cm x 10cm)
- FACC508-0463 Tall T Shape
9" x 8" x 4¹/₂" (23cm x 20cm x 11cm)

5 **Gel Prone/Supine Headrest**

- FACC508-0464 w/Anesthesia Tube Cutouts
11" x 9" x 6" (28cm x 23cm x 15cm)

Chest and Axillary Postioners & Rolls

6 **Gel Pediatric Chest Roll Flat Bottom**

- FACC508-0418 10" x 2" x 2" (25cm x 5cm x 5cm)
- FACC508-0419 10" x 3" x 3" (25cm x 8cm x 8cm)
- FACC508-0420 4" x 2" x 2" (10cm x 5cm x 5cm)
- FACC508-0421 4" x 3" x 3" (10cm x 8cm x 8cm)
- FACC508-0422 6" x 2" x 2" (15cm x 5cm x 5cm)
- FACC508-0423 6" x 3" x 3" (15cm x 8cm x 8cm)
- FACC508-0424 8" x 2" x 2" (20cm x 5cm x 5cm)
- FACC508-0425 8" x 3" x 3" (20cm x 8cm x 8cm)
- FACC508-0550 12" x 2" x 2" (31cm x 5cm x 5cm)
- FACC508-0551 12" x 3" x 3" (31cm x 8cm x 8cm)

Patient Handling



Gel Pads & Positioners to position every patient

7 Gel Chest Roll- Flat Bottom

FACC508-0456 12" x 4" x 4"
(31cm x 10cm x 10cm)

FACC508-0457 12" x 6" x 6"
(31cm x 15cm x 15cm)

FACC508-0458 16" x 4" x 4"
(41cm x 10cm x 10cm)

FACC508-0459 16" x 6" x 6"
(41cm x 15cm x 15cm)

FACC508-0460 20" x 4" x 4"
(51cm x 10cm x 10cm)

FACC508-0461 20" x 6" x 6"
(51cm x 15cm x 15cm)

Gel Contoured Chest Roll Flat Bottom

FACC508-0529 20" x 6 $\frac{1}{4}$ " x 5"
(51cm x 16cm x 13cm)

FACC508-0530 16" x 6 $\frac{1}{4}$ " x 5"
(41cm x 16cm x 13cm)

FACC508-0534 12" x 6 $\frac{1}{4}$ " x 5"
(31cm x 16cm x 13cm)

8 Gel Chest Positioner

FACC508-0474 Left, 23 $\frac{1}{28}$ " x 8" x 3"
(2cm x 20cm x 8cm)

FACC508-0475 Right, 23 $\frac{1}{28}$ " x 8" x 3"
(2cm x 20cm x 8cm)

FACC508-0476 Left & Right, 23 $\frac{1}{28}$ " x 8" x 3"
(2cm x 20cm x 8cm)

9 Gel Lateral Positioner Pad

FACC508-0494 28" x 20" x 1 $\frac{1}{2}$ "
(71cm x 51cm x 1cm)

10 Gel Axillary Roll Cover w/Hook & Loop VELCRO® brand fastener

FACC508-0556 17" x 2" x 1 $\frac{1}{2}$ "
(43cm x 5cm x 1cm)

FACC508-0557 18" x 18" x 1 $\frac{1}{2}$ "
(46cm x 46cm x 1cm)

Foot, Hip, Heel, Knee & Stirrup Pads

11 Gel Candy Cane Pole Pad

FACC508-0453 25" L x 2" I.D (64 cm x 5cm)

12 Gel Ankle Candy Cane Stirrup Pad

FACC508-0506 Small, 12 $\frac{1}{2}$ " x 17 $\frac{7}{8}$ " x 3 $\frac{3}{8}$ "
(32cm x 5cm x 1cm)

FACC508-0507 Large, 17 $\frac{3}{8}$ " x 17 $\frac{7}{8}$ " x 3 $\frac{3}{8}$ "
(32cm x 5cm x 1cm)

13 Gel Clam Shell Heal Pad

FACC508-0451 12 $\frac{1}{2}$ " x 7 $\frac{3}{4}$ " x 1 $\frac{1}{2}$ "
(32cm x 20cm x 1cm)

14 Gel Lithotomy Boot Pad

FACC508-0437 Small, 24" x 11 $\frac{1}{2}$ " x 6"
(61cm x 29cm x 15cm)

FACC508-0438 Large, 27" x 14 $\frac{1}{2}$ " x 8"
(69cm x 37cm x 20cm)

Patient Handling

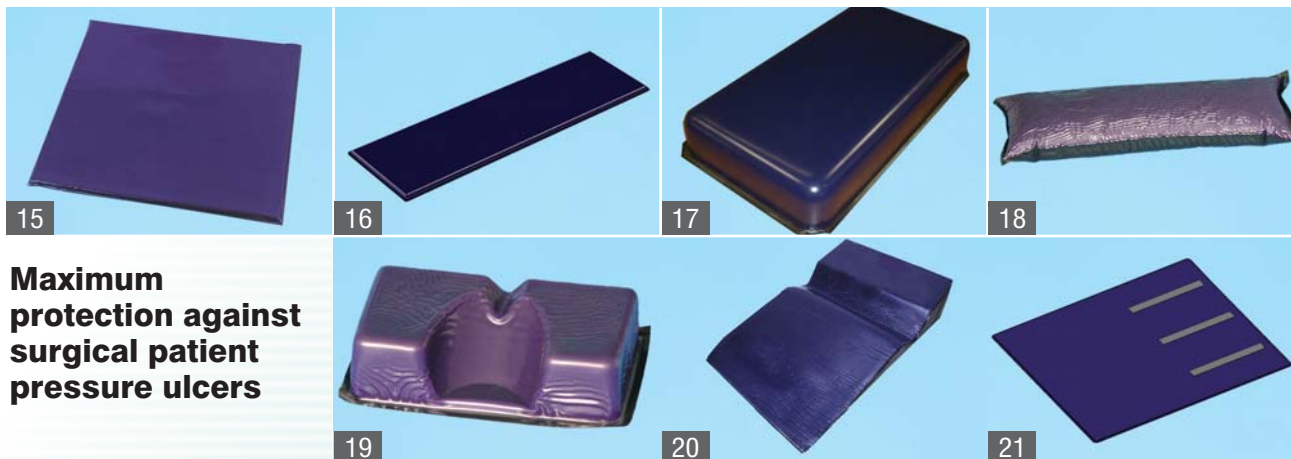

Maximum protection against surgical patient pressure ulcers

Foot, Hip, Heel, Knee & Stirrup Pads

15

Gel Knee Crutch Pad

- FACC508-0452 Small, 11" x 9" x $\frac{3}{8}$ "
(28cm x 23cm x 1cm)
- FACC508-0415 Med., 17" x 11" x $\frac{3}{8}$ "
(43cm x 28cm x 1cm)
- FACC508-0435 Lg., 20" x 20" x $\frac{1}{2}$ "
(51cm x 51cm x 1cm)
- FACC508-0465 X-Lg., 27" x 11" x $\frac{1}{2}$ "
(69cm x 28cm x 1cm)

Gel Bariatric Knee Crutch Pad

- FACC508-0483 Small, 11" x 9" x 1"
(28cm x 23cm x 3cm)
- FACC508-0484 Medium, 17" x 11" x 1"
(43cm x 28cm x 3cm)
- FACC508-0485 Large, 20" x 20" x 1"
(51cm x 51cm x 3cm)

16

Gel Foot/Heel Protector Pad

- FACC508-0450 15" x 4" x $\frac{3}{8}$ "
(38cm x 10cm x 1cm)

17

Orthopedic Hip Positioner with Rigid Foam Core

- FACC508-0561 16" x 8 $\frac{1}{2}$ " x 2 $\frac{5}{8}$ "
(41cm x 22cm x 7cm)

18

Gel Sandbags

- FACC508-0454 Small
10" x 4 $\frac{1}{2}$ " x 2" (25cm x 11cm x 5cm)
- FACC508-0455 Large
14" x 5" x 2" (36cm x 13cm x 5cm)

- FACC508-0466 X-Large
16" x 12" x 1 $\frac{1}{2}$ " (41cm x 31cm x 4cm)
- FACC508-0496 Pediatric
6" x 1 $\frac{1}{2}$ " x 1 $\frac{1}{2}$ " (15cm x 4cm x 4cm)
- FACC508-0497 Pediatric
8" x 1 $\frac{1}{2}$ " x 1 $\frac{1}{2}$ " (20cm x 4cm x 4cm)
- FACC508-0498 Pediatric
6" x 2" x 2" (15cm x 5cm x 5cm)
- FACC508-0499 Medium
12" x 4 $\frac{1}{2}$ " x 1 $\frac{1}{2}$ " (31cm x 11cm x 4cm)
- FACC508-0500 Medium Extra Thick
12" x 4 $\frac{1}{2}$ " x 2" (31cm x 11cm x 5cm)
- FACC508-0511 Large
18" x 4 $\frac{1}{2}$ " x 2" (46cm x 11cm x 5cm)
- FACC508-0519 X-Large
21" x 5" x 2 $\frac{1}{2}$ " (53cm x 13cm x 6cm)
- FACC508-0521 Neonatal
4" x $\frac{1}{2}$ " x $\frac{1}{2}$ " (10cm x 1cm x 1cm)
- FACC508-0522 Neonatal
6" x $\frac{1}{2}$ " x $\frac{1}{2}$ " (15cm x 1cm x 1cm)
- FACC508-0523 Neonatal
8" x $\frac{1}{2}$ " x $\frac{1}{2}$ " (20cm x 1cm x 1cm)
- FACC508-0524 Neonatal
4" x 1" x 1" (10cm x 3cm x 3cm)
- FACC508-0525 Neonatal
6" x 1" x 1" (15cm x 3cm x 3cm)
- FACC508-0526 Neonatal
8" x 1" x 1" (20cm x 3cm x 3cm)
- FACC508-0528 Pediatric
12" x 1 $\frac{1}{2}$ " x 1 $\frac{1}{2}$ " (31cm x 4cm x 4cm)
- FACC508-0547 Medium, Bariatric
13" x 7" x 3" (33cm x 18cm x 8cm)
- FACC508-0548 Large, Bariatric
15" x 8" x 3" (38cm x 20cm x 8cm)

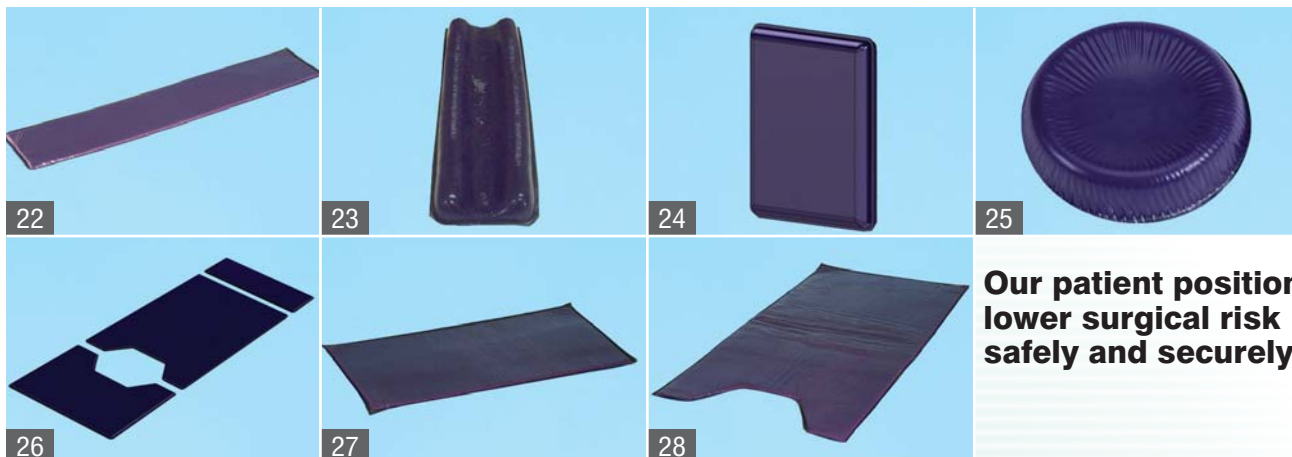

**Our patient positioners
lower surgical risk
safely and securely**

Elbow, Arm & Shoulder Pads

19

FACC508-0477 **Gel Heel Cups**
6" x 3¹/₄" x 1³/₄" (15cm x 8cm x 4cm)

20

FACC508-0449 **Gel Oval Ulnar Nerve Pad**
18" x 6" x 3³/₈" (46cm x 15cm x 1cm)

21

FACC508-0513 **Gel Square Ulnar Nerve Pad**
24" x 21" x 1¹/₄" (61cm x 53cm .6cm)

FACC508-0518 **Gel Ulnar Nerve Protector with
VELCRO® brand fastener,**
30" x 25" x 1¹/₄" (76cm x 64cm x .6cm)

FACC508-0448 **Gel Square Ulnar Nerve Pad**
17" x 11" x 3³/₈" (43cm x 28cm x 1cm)

22

Gel Armboard Pad

FACC508-0433 Large
25" x 5" x 3³/₈" (64cm x 13cm x 1cm)

FACC508-0434 X-Large
26" x 6" x 3³/₈" (66cm x 15cm x 1cm)

FACC508-0445 Small
15" x 4" x 1¹/₄" (38cm x 10cm x .6cm)

FACC508-0514 Large
25" x 7" x 1" (64cm x 18cm x 3cm)

FACC508-0535 Medium
20" x 5" x 1¹/₄" (51cm x 13cm x .6cm)

FACC508-0480 **Gel DuraBoard Pad Short**
15" x 6" x 3³/₈" (38cm x 15cm x 1cm)

23 **Gel Contoured Armboard Pad**

FACC508-0508 Medium
20" x 5³/₄" x 2¹/₄" (51cm x 15cm x 6cm)

FACC508-0512 Small
16" x 5³/₄" x 2¹/₄" (41cm x 15cm x 6cm)

24

FACC508-0509 **Gel Shoulder/Kidney Brace Pad Set**
7" x 6" x 1" (18cm x 15cm x 3cm)

25

FACC508-0555 **Gel Elbow Pad**
3¹/₄" O.D. X 1¹/₂" X 3³/₄" (8cm x 4cm x 2cm)

Surgical Table Pads

26

FACC508-0426 **Gel Three Piece Pad Set**
Universal

27

FACC508-0427 **Gel Head Section Pad**
20" x 9" x 1¹/₂" (51cm x 23cm x 1cm)

28

FACC508-0428 **Gel Torso Section Pad**
39¹/₂" x 20" x 1¹/₂" (100cm x 51cm x 1cm)

Patient Handling

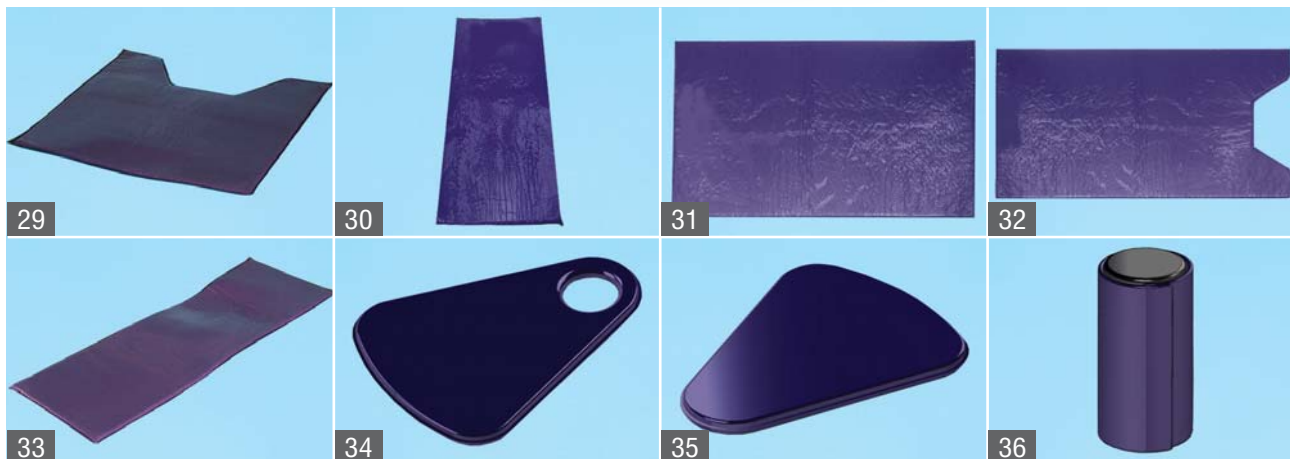

(Surgical Table Pads continued)

29

FACC508-0429 **Gel Foot Section Pad w/Cutout**
20" x 20" x 1/2" (51cm x 51cm x 1cm)

30

FACC508-0442 **Gel Full Table Pad**
72" x 20" x 1/2" (183cm x 51cm x 1cm)

31

FACC508-0440 **Gel 3/4 Table Pad w/no Cutout**
46" x 20" x 1/2" (117cm x 51cm x 1cm)

FACC508-0536 **Gel Cysto Table Pad**
44" x 28" x 1/2" (112cm x 71cm x 1cm)

FACC508-0545 **Gel Cysto Table Pad**
30" x 24" x 1/2" (76cm x 61cm x 1cm)

32

FACC508-0441 **Gel 3/4 Table Pad w/Cutout**
46" x 20" x 1/2" (117cm x 51cm x 1cm)

33

FACC508-0517 **Gel Cysto Table Pad**
25 1/2" x 11 1/2" x 1/2" (65cm x 29cm x 1cm)

FACC508-0533 **Gel Table Pad**
18 1/2" x 7" x 2 1/2" (47cm x 18cm x 6cm)

FACC508-0542 **Gel Table Pad**
36" x 10" x 1/2" (91cm x 25cm x 1cm)

FACC508-0543 **Gel Table Pad**
60" x 10" x 1/2" (152cm x 25cm x 1cm)

FACC508-0544 **Gel Flat Pad**
33" x 18" x 1/2" (84cm x 46cm x 1cm)

FACC508-0546 **Gel Table Pad**
48" x 20" x 1" (122cm x 51cm x 3cm)

34

FACC508-0537 **Gel Fracture Hip Pad**
9" (23cm) tapers to 3" x 7 x 1/2" w/1 3/4"
(8cm x 18cm x 1cm w/4cm) Post Hole

35

FACC508-0539 **Gel Sacral Pad**
9"(23cm) tapers to 3" x 7 x 1/2"
(8cm x 18cm x 1cm)

36

FACC508-0538 **Gel Fracture Table Post Pad
w/Hook & Loop VELCRO® brand fastener,**
7" x 5 1/2" x 1/4" (18cm x 14cm x .6cm)

Specialty Pads

37

Gel Wilson Frame Pad
FACC508-0471 Each
29" x 10" x 1/2" (74cm x 25cm x 1cm)

38

FACC508-0558 Set of 2
29" x 10" x 1/2" (74cm x 25cm x 1cm)

38

FACC508-0430 **Gel Hip Pad**
20" x 20" x 1/2" (51cm x 51cm x 1cm)

FACC508-0502 **Gel Table Peg Board Pad**
32" x 20" x 1/2" (81cm x 51cm x 1cm)

39

FACC508-0436 **Gel Pediatric Pad**
17" x 11" x 1/4" (43cm x 28cm x .6cm)

FACC508-0503 **Gel Pad**
25" x 12" x 3/4" (64cm x 31cm 2cm)

FACC508-0469 **Gel Layer Pad**
16" x 8" x 1/2" (41cm x 20cm x 1cm)

FACC508-0527 **Gel Pad**
30" x 10" x 1/2" (76cm x 25cm x 1cm)

Patient Handling

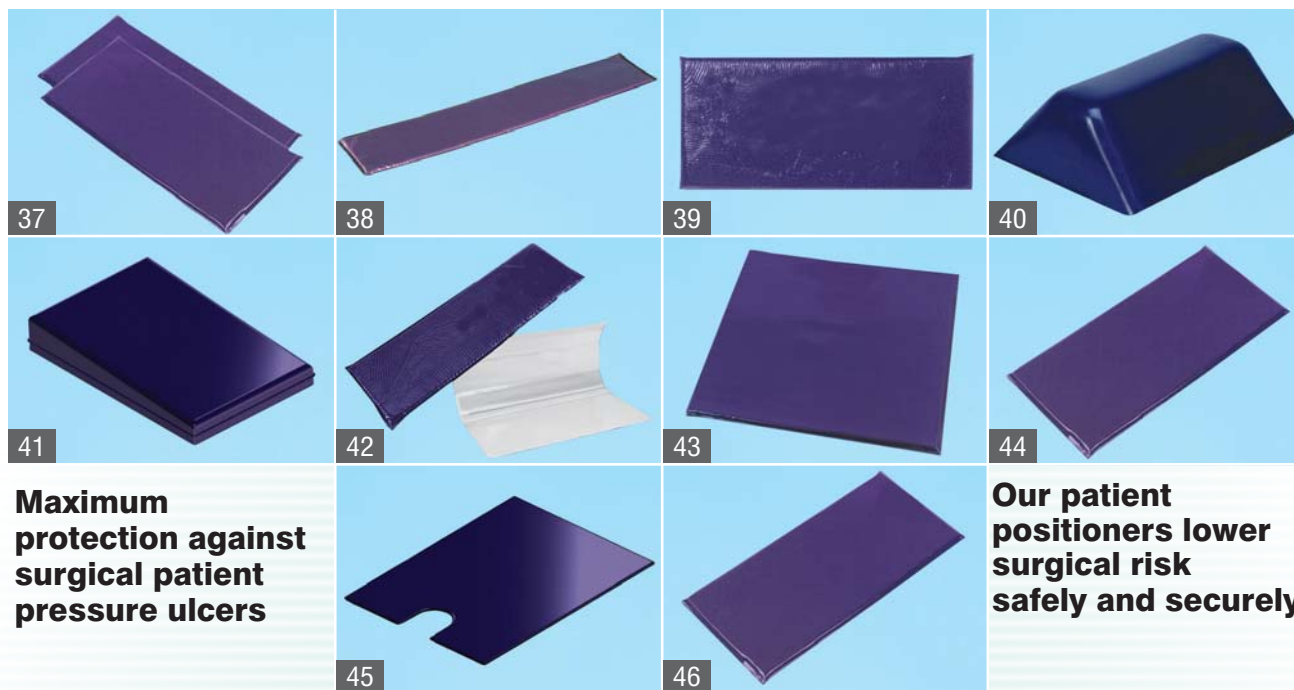

Maximum protection against surgical patient pressure ulcers

Our patient positioners lower surgical risk safely and securely

40

FACC508-0504 **Gel Trapezoidal Positioner**
10" x 7" x 3 1/2" (25cm x 18cm x 9cm)

41

FACC508-0491 **Gel Graduated Thoracic Positioner**
14" x 9" x 2 1/2"-1 1/2"
(36cm x 23cm x 6cm-4cm)

42

FACC508-0510 **Gel Arm Toboggan Pad**
7 3/4" x 6 1/4" x 3/8" (20cm x 16cm x 1cm)

FACC508-0467 **Gel Leg Toboggan Pad**

17" x 6 1/2" x 3/8" (43cm x 17cm x 1cm)

FACC508-0553 **Gel Pad for Arm Shield w/pocket at.**
20" L (51cm)

FACC508-0554 **Gel Toboggan Pad Shield**
16 1/2" x 7 1/2" x 3/8" (42cm x 19cm x 1cm)

43

FACC508-0490 **Gel Andrews Spinal Frame Pad**
22" x 16" x 1" (56cm x 41cm x 3cm)

44

FACC508-0492 **Gel Neonatal Bassinet Pad**
26" x 12" x 1/2" (66cm x 31cm x 1cm)

FACC508-0493 **Gel Neonatal Isolette Pad**
26" x 6" x 1/2" (66cm x 15cm x 1cm)

45

FACC508-0501 **Gel Table Bean Bag Pad**
36" x 28" x 1/2" (91cm x 71cm x 1cm)

46

FACC508-0505 **Gel Mayo Stand Cover**
21" x 18 1/2" x 5/8" (53cm x 47cm x 2cm)

Miscellaneous Pads (no Pictures)

FACC508-0540 **Gel Commode Seat Pad w/Cutout**
18" x 18" x 1" (46cm x 46cm x 3cm)

FACC508-0541 **Gel Commode Seat Pad**
16" x 16" x 5/8" (41cm x 41cm x 2cm)

FACC508-0549 **Gel Summersville Pad**
12" x 12" x 1/4" (31cm x 31cm x .6cm)

FACC512-0047 **Gel Repair Kit**
4" x 4" (10cm x 10cm)

FACC508-0439 **Prone and Lateral Positioner**
15" x 7" x 1/4" (38cm x 18cm x .6cm)

FACC508-0481 **Med. Bariatric Lap Belt Pad**
36" x 6" x 1/4" (91cm x 15cm x .6cm)

FACC508-0482 **Large Bariatric Lap Belt Pad**
48" x 7" x 1/4" (121cm x 18cm x .6cm)

FACC508-0495 **Epidural Head Rest**
13" x 5" x 1/4" (33cm x 13cm x .6cm)

FACC508-0531 **OR Table Pad**
37" x 12" x 1" (127cm x 31cm x 2cm)

Patient Handling

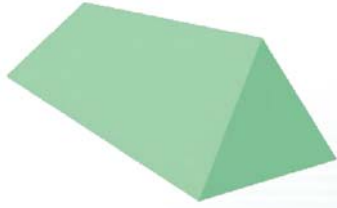

**TE-YCEE 45° Echnocardiography Wedge Coated
Sponge 13" x 38.25" x 9"**



**TE-YCBB 45° Spinal Wedge Coated
Sponge 10" x 20.25" x 7"**



**TE-YCAJ Knee Wedge Support Coated Sponge
22" x 20" x 7"**

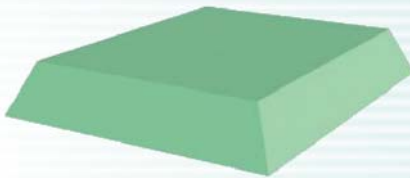

**TE-YCBN 3" Rectangle Coated Positioner
16.5" X 20.5" X 3"**



**TE-YCAG Bilateral Leg Immobilizer Coated Sponge
20" x 21" x 6"**

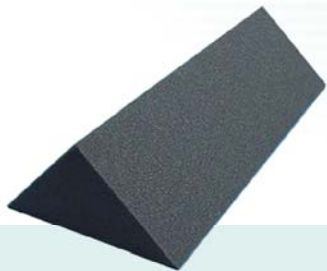

**C02033767-20 Echocardiography Foam Positioning
Wedge 45° (Coated, Royal Blue)**

**C02033767-SC Echocardiography Foam Positioning
Wedge 45° (Coated, White)**

9" x 9" x 30"

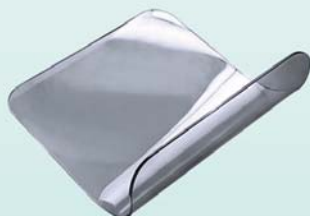

C0209100 Clear-Vu Arm Support 11.75" x 12"



Sandbag Positioning

Ultralite Sandbags

1/3 the weight of heavy sand, reusable, covered with black vinyl, great for patient positioning, steady & firm support, available with or without grommets.

CUSB-2002 - 2 lbs., 8" x 11" positioner

CUSB-2003 - 3 lbs., 9" x 13" positioner

CUSB-2005 - 5 lbs., 10" x 15" positioner

CUSB-2007 - 7 lbs., 11" x 16" positioner

CUSB-2010 - 10 lbs., 12" x 19" positioner

CUSB-2202 - 2 lbs., 8" x 11" positioner w/ grommets

CUSB-2203 - 3 lbs., 9" x 13" positioner w/ grommets

CUSB-2205 - 5 lbs., 10" x 15" positioner w/ grommets

CUSB-2207 - 7 lbs., 11" x 16" positioner w/ grommets

CUSB-2210 - 10 lbs., 12" x 19" positioner w/ grommets

Heavy Fill Sandbags

Reusable, covered with black vinyl, great for patient positioning, steady & firm support, available with or without grommets. Custom weights & sizes available upon request.

CUSB-1002 - 2 lbs., 8" x 11" positioner

CUSB-1003 - 3 lbs., 9" x 13" positioner

CUSB-1005 - 5 lbs., 10" x 15" positioner

CUSB-1007 - 7 lbs., 11" x 16" positioner

CUSB-1010 - 10 lbs., 12" x 19" positioner

CUSB-1202 - 2 lbs., 8" x 11" positioner w/ grommets

CUSB-1203 - 3 lbs., 9" x 13" positioner w/ grommets

CUSB-1205 - 5 lbs., 10" x 15" positioner w/ grommets

CUSB-1207 - 7 lbs., 11" x 16" positioner w/ grommets

CUSB-1210 - 10 lbs., 12" x 19" positioner w/ grommets

Surgical Lights

FHC iCE LED Surgical Light

- **Illuminance:** available in 160,000, and 130,000 lux
- **Color Temperature:** 4500°K
- **Diameter of Lighthouse:** 30in. and 25in. (for iCE 25 LED)
- **Light Field Diameter:** 7.6 - 12" (7.5-11" for iCE 25 LED)
- **Focusing:** Adjustable by rotating focus handle
- **CRI (Color Rendering Index):** 95
- **Rotation:** 360° (limitless) on single ceiling models
- **Sterilizable Handle:** Removable
- **Number of Bulbs:** 80 main (52 main for iCE 25 LED)
- **Light Source:** LED
- **Rated life of LED Lamp:** 50,000 hours
- **Mounting Options:** ceiling, wall
- **Warranty:** 5 year limited warranty



AML-ILED-30

The iCE LED Surgical Lighting System brings the newest LED technology to the Operating Room. The iCE LED Surgical Lights are designed for superior shadow control, increased depth of field and light intensity. The iCE Surgical Lighting System comes standard with an in-light HD camera. Each iCE LED is upgradable and customizable and can be ordered in a variety of configurations.

FHC Mira LED Surgical Light

- **Illuminance:** available in 50,000, 65,000, and 90,000 lux
- **Color Temperature:** 4500°K
- **Diameter of Lighthouse:** 18"
- **Light Field Diameter:** 6.5 - 12"
- **Focusing:** Twist handle
- **CRI (Color Rendering Index):** 95
- **Rotation:** 360° (limitless) on single ceiling models
- **Sterilizable Handle:** Removable
- **Number of Bulbs:** 36
- **Light Source:** LED
- **Rated life of LED Lamp:** 50,000 hours
- **Mounting Options:** ceiling, wall, or roll stand
- **Warranty:** 5 year limited warranty



AML-MLED-65

As the latest advancement in minor surgery and diagnostic lighting technology, the Mira Series LED Surgical Light's precisely positioned LED's ensure superior shadow control, depth of field, and light intensity. A slim design and control pad on the lighthouse provide reduced workspace clutter and easy access to light functions. With a CRI of 95 and color temperature of 4500K, the Mira LED Medical Light creates outstanding color accuracy for minor surgeries and examinations.

Surgical Lights

FHC AIM-100 Surgical Light

- **Illuminance:** 63,000 lux at 1 meter
- **Color Temperature:** 3500°K
- **Diameter of Lighthouse:** 20"
- **Light Field Diameter:** 9.6 - 12"
- **Focusing:** adjustable by rotating center handle
- **CRI (Color Rendering Index):** 97
- **Rotation:** 360° (limitless) on single ceiling models
- **Sterilizable Handle:** locks into position w/ one hand
- **Number of Bulbs:** 3
- **Light Source:** Halogen 35 W, 12 v
- **Rated life of Halogen Lamp:** 2,000 hours
- **Mounting Options:** single/double ceiling, floor, & wall
- **Lighthouse Diameter:** 20"
- **Warranty:** 5 year limited warranty



Delivering the highest intensity illumination and smooth focus, the AIM-100 provides the perfect combination of high intensity, performance, limitless rotation and unparalleled aesthetics. The 360° limitless arm and mounting system rotation around vertical axes gives customers the ability to maneuver the surgical light into the widest range of positions possible. The 3 quartz halogen bulbs offer 3500 K color temperatures that give natural and true coloring in the surgery room.

FHC AIM-200 OR Surgical Light

- **Illuminance:** 90,000 lux at 1 meter
- **Color Temperature:** 3700°K
- **Diameter of Lighthouse:** 20"
- **Light Field Diameter:** 10 - 12"
- **Focusing:** adjustable by rotating center handle
- **CRI (Color Rendering Index):** 96
- **Rotation:** 360° (limitless) on single ceiling models
- **Sterilizable Handle:** locks into position w/ one hand
- **Number of Bulbs:** 3
- **Light Source:** Halogen 35 W, 12 v
- **Rated life of Halogen Lamp:** 1,400 hours
- **Mounting Options:** single/double ceiling, floor, & wall
- **Lighthouse Diameter:** 20"
- **Warranty:** 5 year limited warranty



As the newest addition to the AIM series surgical lights, the AIM-200 OR Surgery Light delivers true rendition of colors and provides long hours of use. The AIM-200 surgery light is the first OR light that has options of floor, wall, single-, and double-ceiling mounts available. Providing unlimited rotation and maximum reach along with a light pattern free of cast shadows, the AIM-200 brings the most versatile and practical light into any operating room environment.

Surgical Lights

FHC AIM-LED Examination Light

- **Illuminance:** 45,000 lux at 1 meter
- **Color Temperature:** 4500°K
- **Diameter of Lighthouse:** 18"
- **Light Field Diameter:** 6.5 - 12"
- **Focusing:** Twist handle
- **CRI (Color Rendering Index):** 95
- **Rotation:** 360° (limitless) on single ceiling models
- **Sterilizable Handle:** Removable
- **Number of Bulbs:** 36
- **Light Source:** LED
- **Rated life of LED Lamp:** 50,000 hours
- **Mounting Options:** ceiling, wall, or roll stand
- **Warranty:** 5 year limited warranty



The new AIM-LED combines smart and versatile design from all other AIM lights, with the efficiency and longevity of an LED light. This LED light source surgery light provides 10% more illumination than the already high performing AIM-50 and 10 times more life than halogen light sources, with half the power. The 92 CRI rating of the surgery light creates accurate color visibility for a completely accurate diagnosis.

FHC AIM-50 Examination Light

- **Illuminance:** 45,000 lux at 1 meter
- **Color Temperature:** 3100°K
- **Diameter of Lighthouse:** 20"
- **Light Field Diameter:** 10 - 12"
- **Focusing:** Adjustable by rotating center handle
- **CRI (Color Rendering Index):** 96
- **Rotation:** 360° (limitless) on single ceiling models
- **Sterilizable Handle:** Locks into position w/ one hand
- **Number of Bulbs:** 3
- **Light Source:** halogen, 50 W , 24 v
- **Rated life of Halogen Lamp:** 2,000 hours
- **Mounting Options:** single/double ceiling, floor, & wall
- **Warranty:** 5 year limited warranty



With the highest intensity illumination, the AIM-50 examination light brings unparalleled aesthetics and superior maneuverability. A 360° ceiling mount and center sterilizable handle allow for limitless rotation and smooth focus mechanism. Offering cool operation, the AIM-50 surgical light allows for constant use without ever having overheating issues. The use of three 50-watt quartz halogen bulbs rated with an average 2000 hour bulb life ensure the light shines brightly for ages.

Surgical Lights

FHC Super Exam 50 LED Examination Light

- **Illuminance:** 39,000 lux at 24"
- **Color Temperature:** 4000°K
- **K-Arm Technology:** Drift-free K-arm w/ 42" arm range
- **CRI (Color Rendering Index):** 92
- **Number of Bulbs:** 1
- **Light Source:** LED 15 W
- **Rated life of LED Lamp:** 40,000 hours
- **Mounting Options:** floor, rail, Single ceiling, wall, table
- **Warranty:** 5 year limited warranty



BUSE50LSC

The Super Exam 50 LED examination light combines natural white light, quality intensity, energy savings and durability into one highly-positionable K-arm exam light. Providing the same quality technology as the Super Exam 50, the Super Exam 50 LED delivers higher value with 40,000 hour LED light life, lower energy consumption and versatility. The highly engineered optical system delivers precise, natural, white light for accurate and controlled examination ability.

FHC Super Exam 50 Examination Light

- **Illuminance:** 45,700 lux at 24"
- **Color Temperature:** 3800°K
- **K-Arm Technology:** Drift-free K-arm w/ 42" arm range
- **CRI (Color Rendering Index):** 99
- **Number of Bulbs:** 1
- **Light Source:** LED 15 W
- **Rated life of LED Lamp:** 40,000 hours
- **Mounting Options:** floor, rail, Single ceiling, wall, table
- **Warranty:** 5 year limited warranty

BUSE50SC



Perfectly ideal for obstetrics, gynecology, and emergency rooms, the Super Exam 50 examination light delivers the finest intensity, color temperature, and CRI available in a highly-positionable K-arm. The halogen technology ensures maximum light output and color rendering, whilst the dual lens optical system collects and concentrates precise light beams necessary for every procedure.

Surgical Lights

FHC Nova Exam LED Examination Light

- **Illuminance:** Low lvl - 25,000 lux at 18"
High lvl - 50,000 lux at 18"
- **Color Temperature:** 4600°K
- **Diameter of Lighthouse:** 18"
- **Max Arm Reach:** 45"
- **CRI (Color Rendering Index):** 93
- **Number of Bulbs:** 2 modules
- **Light Source:** LED
- **Rated life of LED Lamp:** 40,000 hours for each module
- **Mounting Options:** ceiling, wall, table, floor
- **Warranty:** 5 year limited warranty



BUNXFL

Designed to provide value for the practitioner and comfort for the patient, the Nova Exam LED exam light produces cool light while delivering a uniform beam pattern and higher illumination levels. The sleek head design, combined with a patented K-arm allows quick and reliable positioning. The cool light produced from the LED light source ensures patient/physician comfort and lower power consumption.

FHC Super Bright Spot Examination Light

- **Illuminance:** 56,000 lux at 18"
- **Color Temperature:** 3400°K
- **Diameter of Lighthouse:** 20"
- **Light Field Diameter:** 4 - 5"
- **CRI (Color Rendering Index):** 98
- **Dichroic Reflector:** Filters out infrared to keep beam cool
- **Number of Bulbs:** 1
- **Light Source:** halogen, 20 W (virtually heat-free)
- **Rated life of Halogen Lamp:** 2,000 hours
- **Mounting Options:** floor, and wall
- **Warranty:** 5 year limited warranty



BUSB40FL

As a pre-focused spot with a 20-watt halogen bulb and special optics system, the Super Bright Spot examination light is perfect for OB/GYNs, urologists, hospitals, clinics, and family practitioners. Being virtually heat-free, the Super Bright Spot ensures superior fiber optic units in value and durable operation, at a reasonable price. The large 4"-5" spot size and 2000 hour bulb life ensure that this exam light provides extraordinary reliability and durability for lasting usage.

Surgical Lights

FHC CoolSpot II Examination Light

- **Illuminance:** 60,000 lux at 1 meter
- **Color Temperature:** 4300°K
- **Light Field Diameter:** 2 - 10"
- **Focusing:** Adjustable by rotating center handle
- **CRI (Color Rendering Index):** 94
- **Rotation:** extension pivots 320° on ceiling
- **Sterilizable Handle:** Removable
- **Number of Bulbs:** 1
- **Light Source:** Halogen, 150 W
- **Rated life of Halogen Lamp:** 600 hours
- **Mounting Options:** single/double ceiling, floor, & wall
- **Warranty:** 5 year limited warranty



Offering extremely white and pure light, the CoolSpot II examination light ensures high-intensity and long-lasting bulb life of 600 hours average on standard setting. The guaranteed no-drift arm and removable, autoclavable center Sterihandle design provide easy maneuvering and simple removal to secure sterilization of the exam light for any necessary procedure.

FHC Outpatient II Examination Light

- **Illuminance:** 86,000 lux at 24"
- **Color Temperature:** 3300°K
- **Diameter of Lighthead:** 18"
- **Light Field Diameter:** 6.5 - 12"
- **Focusing:** Central removable, sterilizable handle
- **CRI (Color Rendering Index):** 94
- **Rotation:** extension pivots 320° on ceiling
- **Sterilizable Handle:** Removable
- **Number of Bulbs:** 3
- **Light Source:** Halogen, 50 W
- **Rated life of Halogen Lamp:** 2,000 hours
- **Mounting Options:** single/double ceiling, floor, & wall
- **Warranty:** 5 year limited warranty



The Outpatient II Surgical Light is the only light in its class with true focusability and enhanced illumination in a flood-type spot. As documented industry leader for minor surgery and procedure lights, the Outpatient II provides maximum intensity and shadow-free operation. A minimal heat output and high color temperature gives the Outpatient II top performing light ability and super low maintenance for every surgery light application in the hospital, surgery center, or physician office.

Surgical Lights

FHC Gleamer Examination Light

- **Illuminance:** 45,000 lux at 18"
- **Color Temperature:** 3200°K
- **Light Field Diameter:** 4 - 5"
- **CRI (Color Rendering Index):** 91
- **Number of Bulbs:** 1
- **Light Source:** halogen, 35 W
- **Rated life of Halogen Lamp:** 4,000 hours
- **Mounting Options:** floor, and wall
- **Warranty:** 5 year limited warranty



The Gleamer was designed to meet healthcare facilities' most demanding specifications for high-intensity, cool operation, compact design, and value. With its unique venting system, The Gleamer exam light includes an energy-absorbing infrared exchanger and reflector coatings, which filter out infrared for a nearly heat-free beam in a cool, yet compact housing.

FHC XenaLux OR Headlamp System

- **Illuminance:** 120,000 lux at working distance
- **Color Temperature:** 3400°K
- **Number of Bulbs:** 1
- **Light Source:** xenon, 300 W
- **Rated life of Xenon Lamp:** 500 hours
- **Warranty:** 3 year limited warranty



The XenaLux Headlamp was carefully designed to create the perfect circular beam for any variable spot. With its extremely bright xenon light, working at a distance has never been easier, or more visible. The XenaLux's 300 watt power output illuminator ensures highest intensity white light of any 300 watt xenon source and a quiet, cool venting system.

Surgical Lights

Lighting Solution Guide: Which Light is The Right Light?

Dept./Specialty	Good	Better	Best
Hospital			
G OR	AIM-200 OR (D)	APEX (S)	APEX (D)
Endo	AIM LED (D)	AIM-100 (D)	APEX (D)
Ortho	AIM-200 OR (S)	AIM-200 OR (D)	APEX
CVOR head	AIM-200 OR (S)	AIM-200 OR (D)	APEX
CVOR foot	AIM-200 OR (S)	AIM-200 OR (D)	APEX
Trauma	AIM LED (D)	AIM-100 (D)	APEX (D)
ED	Outpatient II/CoolSpot II	AIM LED (D)	AIM-100 (S)
LDR	Outpatient II	CoolSpot II	AIM LED
ICU	Outpatient II	CoolSpot II	AIM LED
Autopsy	Outpatient II	CoolSpot II	AIM LED
Cath	Outpatient II	CoolSpot II	AIM LED
ProCed	Outpatient II	AIM LED	AIM-100
Patient room	Light Caress PC	Light Caress PC	Light Caress XC
Exam	Gleamer	Nova Exam LED	Outpatient II
ASC			
Endo	AIM LED	AIM-100	APEX
Plastic	AIM LED	AIM-100	APEX
Ophtha	Outpatient II	AIM LED	AIM-100
Ortho	AIM LED	AIM-100 (D)	AIM-200 OR (D)
G OR	AIM-100	AIM-200 OR	APEX
Office			
Plastic	Outpatient II	AIM LED	AIM-100
Derm	Outpatient II	CoolSpot II	AIM LED
Clinics	Outpatient II	CoolSpot II	AIM LED
OB/GYN	Gleamer	Nova Exam LED	CoolSpot II
Diag	Outpatient II	CoolSpot II	AIM LED
Exam	Gleamer	Nova Exam LED	Outpatient II
Veterinary			
Major surgery	AIM-100	AIM-200 OR	APEX
Minor surgery	Outpatient II	AIM LED	AIM-100
Diag	Outpatient II	CoolSpot II	AIM-50
Exam	Gleamer	Nova Exam LED	Outpatient II
Dental exam	Super Exam 50 LED	Nova Exam LED	CoolSpot II
Magnifier	UV Light	Epic Magnifier	Wave Plus
Dental			
Max	Outpatient II/CoolSpot II	AIM LED	AIM-100
Exam	Gleamer	Nova Exam LED	CoolSpot II

(D) = Double (S) = Single

Surgical Scrub Sinks

Manufactured of the highest quality possible, Future Health Concepts delivers a full line of hands-free, fully functional Surgical Scrub Sinks. Combining the best materials, components, & craftsmanship available, each sink is hand built to the customer's specific needs.

We work with you to determine exactly what specifications and then build it at a budget-friendly price. Whether you need a single, double or even triple scrub sink, FHC can provide it all.

SS Series Scrub Sink Standard Features:

- Deep sloping basin
- Adjustable thermostatic controlled pressure regulates mixing valves (one per station)
- Check stop strainers for ease of maintenance
- High mount swivel gooseneck spout w/ adjustable swivel spray aerator
- Flow control valve
- Backflow preventers
- Infrared sinks equipped with 24 volt plug in transformer
- Splash screen dividers with double and triple station sinks
- Main support and Z-brackets (in-wall support optional)
- 304 stainless steel polished and ground to a #4 finish



FHCSS32-PB
(Optional Pedestal Base Shown)

ES Series Scrub Sink Standard Features:

- Deep sloping basin
- Adjustable thermostatic controlled pressure regulates mixing valves (one per station)
- High mount swivel gooseneck spout w/ adjustable swivel spray aerator
- Flow control valve
- Backflow preventers
- Infrared sinks equipped with 24 volt plug in transformer
- Z-brackets (in-wall support optional)
- 304 stainless steel polished and ground to a #4 finish
- Smaller outside dimensions w/ deep basin for more economical choice



FHCES25-IR-MB

Surgical Scrub Sinks

SS Surgical Scrub Sink Options:

Knee Operated Surgical Scrub Sinks:

The operation of these sinks is very simple. Press knee panel one time to activate water flow. Press again to stop flow. The soap panel works in a pumping fashion with soap being dispensed through a stainless steel spout located near the mixing valve. The base has been designed to accommodate gallon sized soap container storage behind the knee panels.



FHCSS32

Infrared Operated Surgical Scrub Sinks:

The infrared sensor is located on the front of each station and is activated by the user's waist. There is a 2 second on/off delay for water flow. The sensor range is 12" to 14". Both features combined eliminate activation by simply passing by. Optional knee operated or foot control soap pumps are available.



FHCSS64-IR-TM-EW-PB

Deluxe Surgical Scrub Sinks:

Built as a hybrid, these sinks have dual controls. Equipped with a infrared operated water control as well as a manual bypass for knee operated water control. The main operation is via infrared sensor located between the knee panels. The operation for water control is on standby as a backup. In addition, the sink is also equipped with knee operated soap.



FHCSS64-IR-MB

Surgical Scrub Sinks

SS Series Surgical Scrub Sink Features & Options:

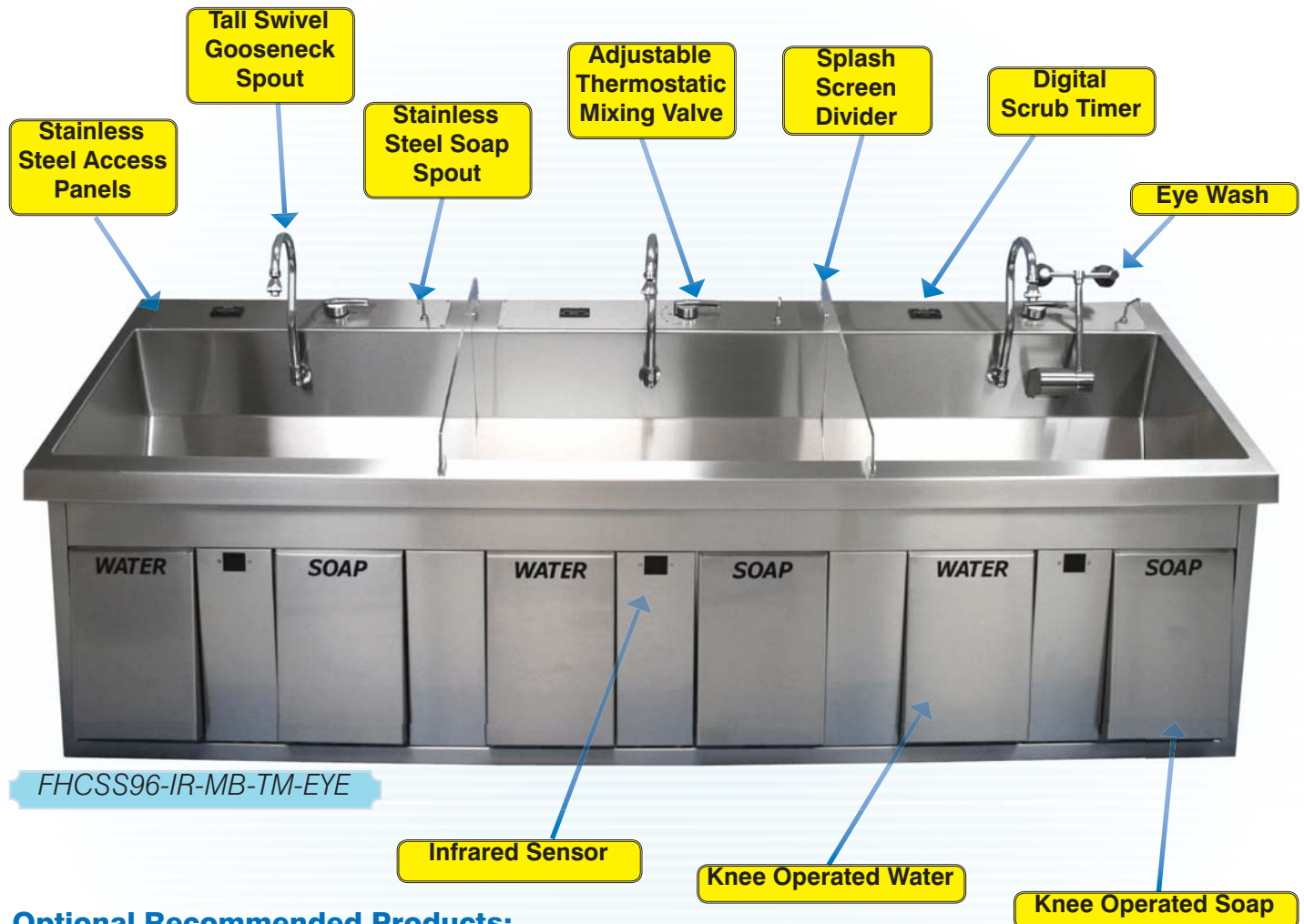

Optional Recommended Products:

Sink Model	In-Wall Chair Carrier #	Shelf Over Sink #	Lighted Shelf Over Sink #
Single	P-617106-846	FHCSS3211.5	FHCSSL3211.5
Double	P-617106-851	FHCSS6411.5	FHCSSL6411.5
Triple	P-617106-852	FHCSS9611.5	FHCSSL9611.5

How to Order Our SS Series Scrub Sinks:

Options Available	Infrared Operation	Manual Bypass to add Knee Operated Water and Soap With IR Operation	Knee Operated Soap With IR Operation	Foot Operated Soap (All Sinks)	Digital Scrub Timer	Eye Wash	220-240V	Pedestal Base
Option Extension	IR	MB	KSP	FSP	TM	EYE	220	PB

Examples: Model # FHCSS64 Infrared Operated w/ Knee Operated Water and Soap plus Digital Scrub Timers = Our Model # FHCSS64-IR-MB-TM

Surgical Scrub Sinks

SS Series Surgical Scrub Sink Specifications:

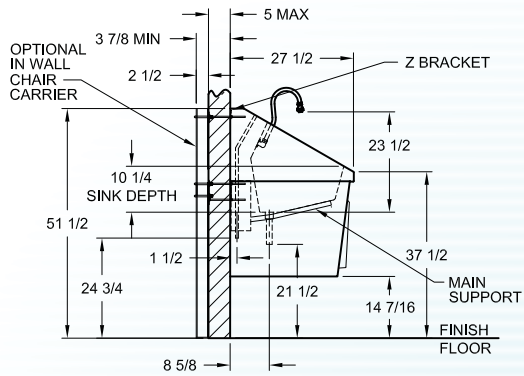

FHCSS-32

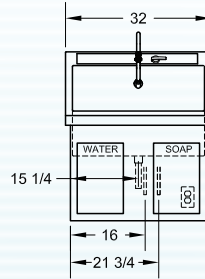

FHCSS-32

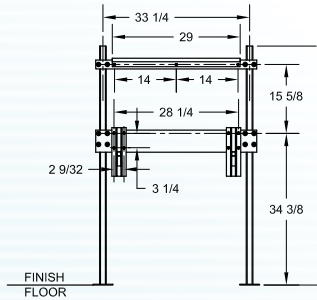

FHCSS-64

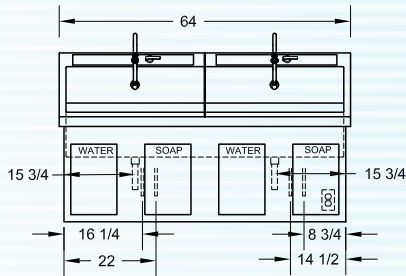

FHCSS-64

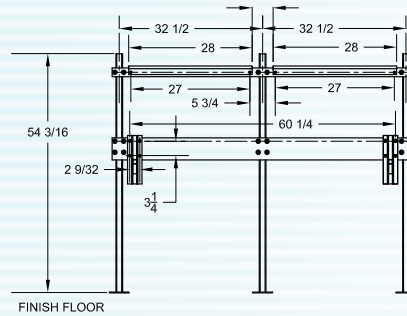

FHCSS-96

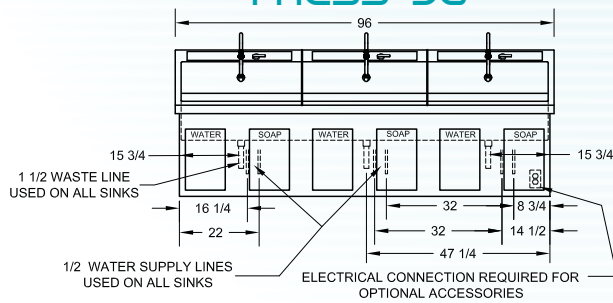

FHCSS-96

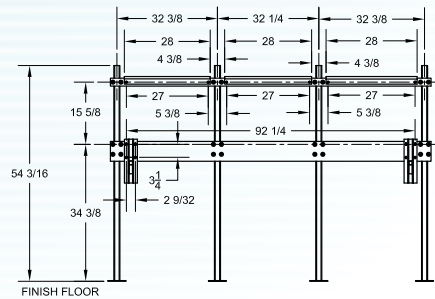

1/2" WATER SUPPLY LINE DETAIL
USED ON ALL SS SERIES SINKS



Surgical Scrub Sinks

ES Series Surgical Scrub Sink Features & Options:

Our ES series scrub sinks were developed to be the answer to space and economical constraints. The ES series sinks have a smaller outside dimension, but still have a deep basin to allow for a proper scrub. The operation of the ES sinks are the same as that of the SS series sinks but the features do vary.



How to Order Our ES Series Scrub Sinks:

Options Available	Infrared Operation	Manual Bypass to add Knee Operated Water and Soap With IR Operation	Knee Operated Soap With IR Operation <small>(Soap is not a standard feature w/ knee operated water on ES series sinks)</small>	Foot Operated Soap (All Sinks)	Digital Scrub Timer	Eye Wash	220-240V	Pedestal Base
Option Extension	IR	MB	KSP	FSP	TM	EYE	220	PB

Example: Model # FHCES47 Knee Operated Soap and Eye Wash with Pedestal Base = Our Model # FHCES47-KSP-EYE-PB

Surgical Scrub Sink Utility Requirements:

Utility	Connection On Unit	Pressure Range	Temperature	Consumption
Drain	1 1/2" x 6" Tail Piece	N/A	N/A	N/A
Cold Water	1/2" NPT	20-50 PSIG	70 Degree F. Max	2 GPM Per Station
Hot Water	1/2" NPT	20-50 PSIG	180 Degree F. Max	2 GPM Per Station
Electrical (IR Units Only)	120V	N/A	N/A	N/A

Surgical Scrub Sinks

ES Series Surgical Scrub Sink Specifications:

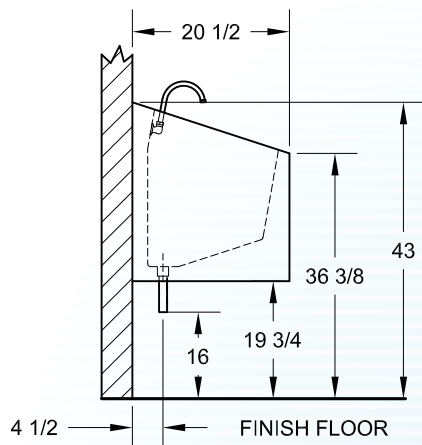

FHCES-25

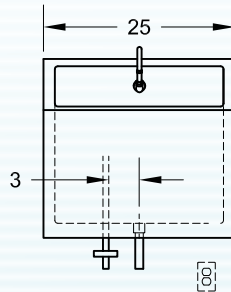

FHCES-25

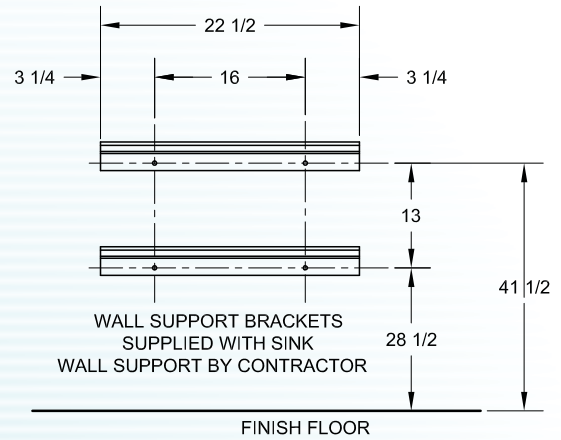

FHCES-47

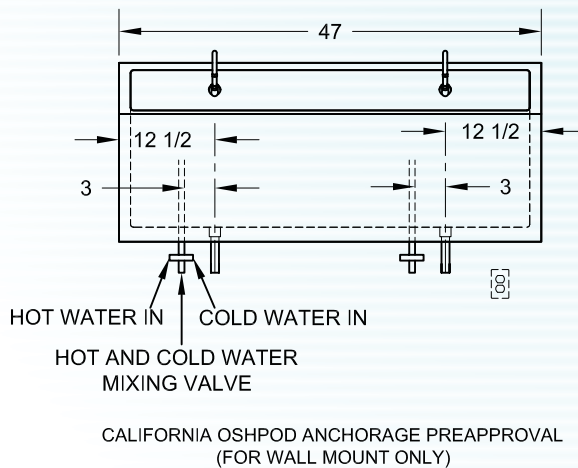

FHCES-47

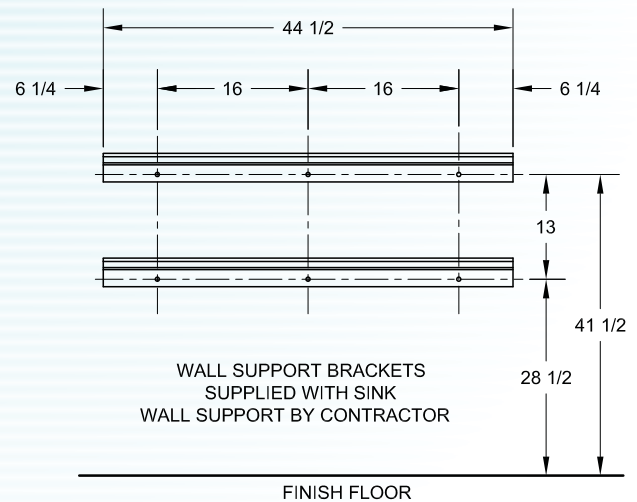

CALIFORNIA OSHPOD ANCHORAGE PREAPPROVAL
(FOR WALL MOUNT ONLY)

Warranty

All Surgical Scrub Sinks manufactured by Future Health Concepts, Inc. will carry a limited lifetime warranty against manufacturing defects and a one year parts and labor warranty. The factory will service all units without cost to the buyer for one year from shipment. After the one year period, replacement of a defective part will be at buyer's expense. We will exchange all defective parts at no cost to the buyer for a period of one year from shipment. All defective parts must be returned within 30 days to ensure proper credit. An RA from Future Health Concepts, Inc. must be obtained prior to items return.

Processing Sinks

At Future Health Concepts, our Processing Sinks/Clean-up Counters are specifically designed to fit your facility's needs. All of our Processing Sinks & Pass-through Windows at FHC are **FULLY CUSTOMIZABLE** for individual requirements of the customer at an affordable price. The quality and design of our sink/window are ensured by its fully welded construction, and sleek stainless steel finish.

FHC Processing Sinks & Clean-up Counter Specs:



Processing Sink Standard Features:

- Fully-welded construction
- Sound-proofed reinforced tops
- Multiple layouts for individual requirements
- All sinks are manufactured to individual specifications
- Full CAD rendering of specific sink

Options:

- Hydraulic adjustable heights for ergonomics
- Full base unit underneath with any door, drawer or open shelf combination
- Pipe stand instead of base unit
- Multiple bowls in any combination
- Multiple faucet options including pre-rinse
- Air hose with 5 blowgun tips
- DI water
- Foot operated drains

Processing Sinks

Sample Processing Sinks:

Single Processing Sink



Double Processing Sink



Triple Processing Sink

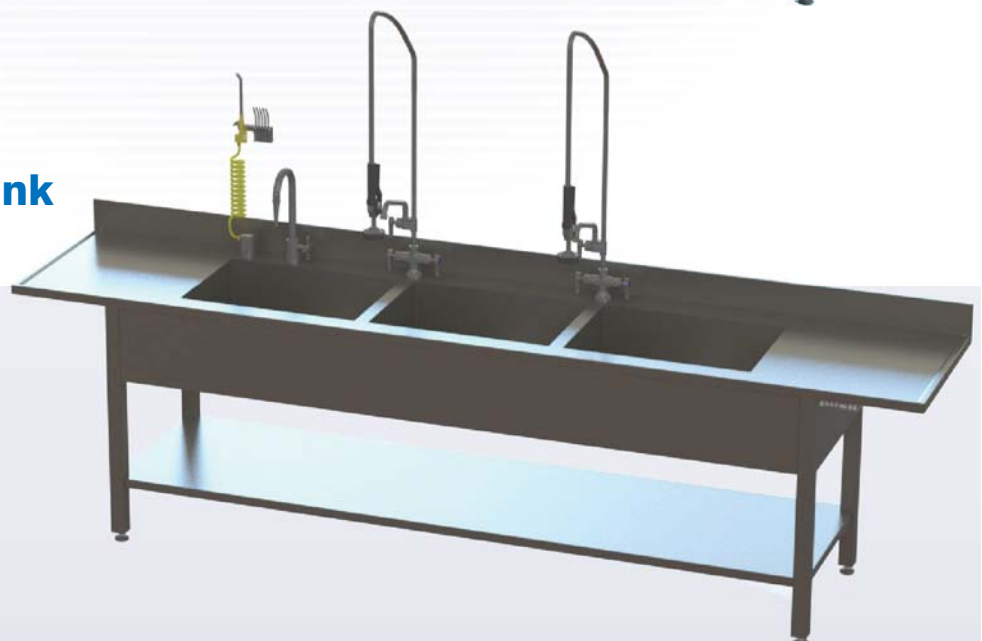

Processing Sinks

Adjustable Processing Sink Drawing Example:

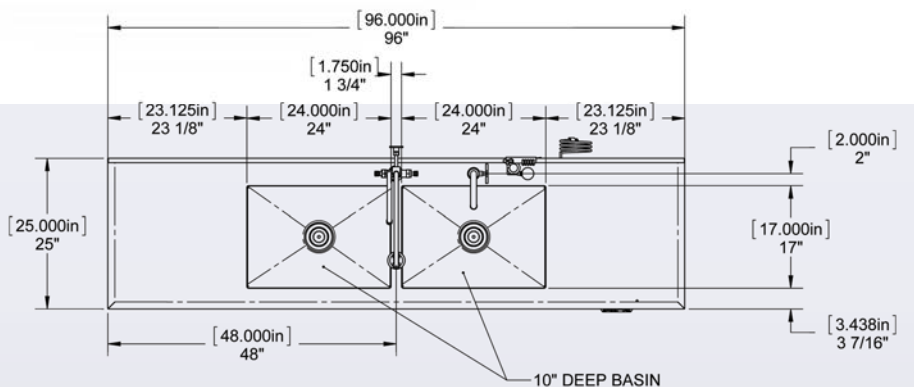
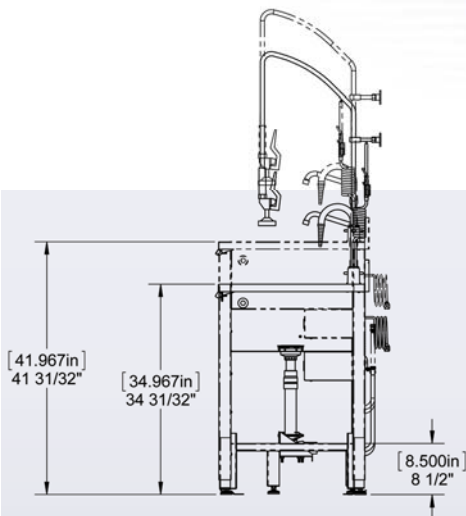
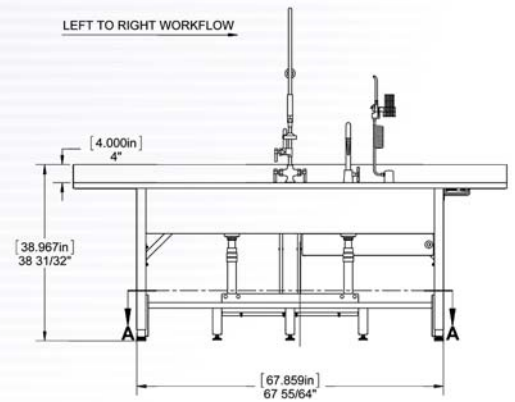
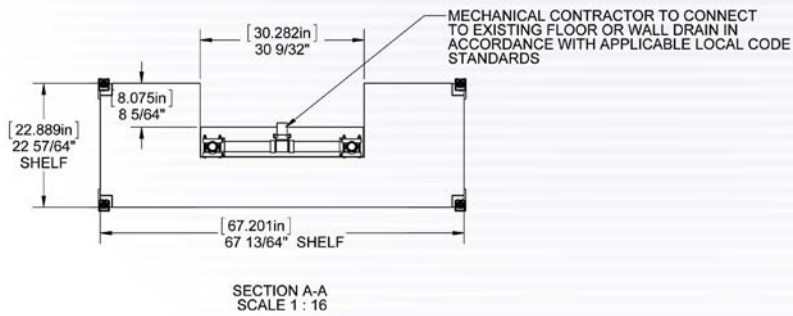
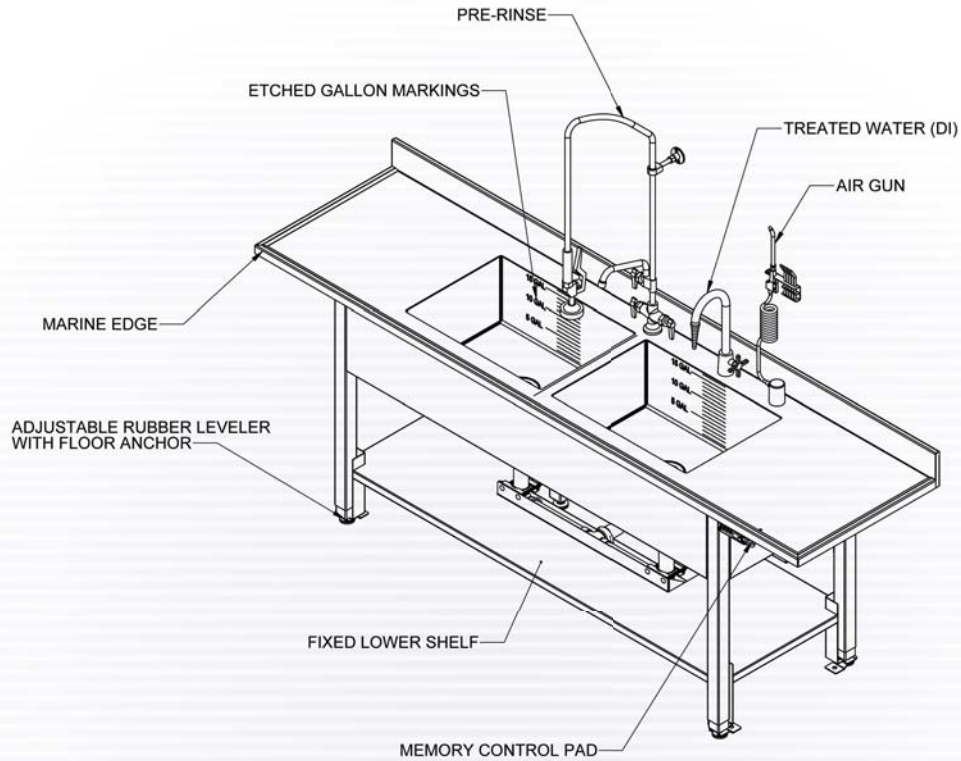

Processing Sinks

Triple Processing Sink Drawing Example:

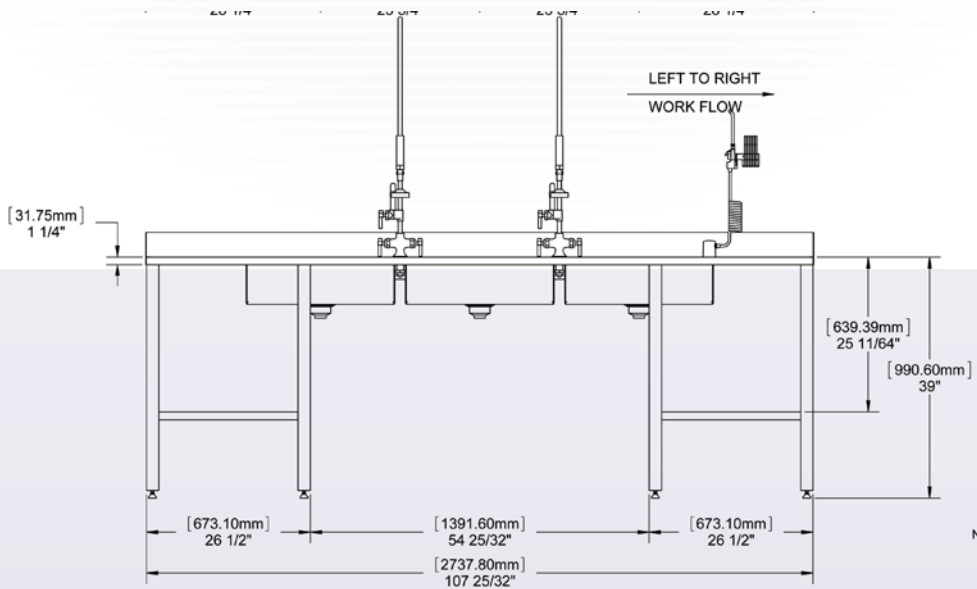
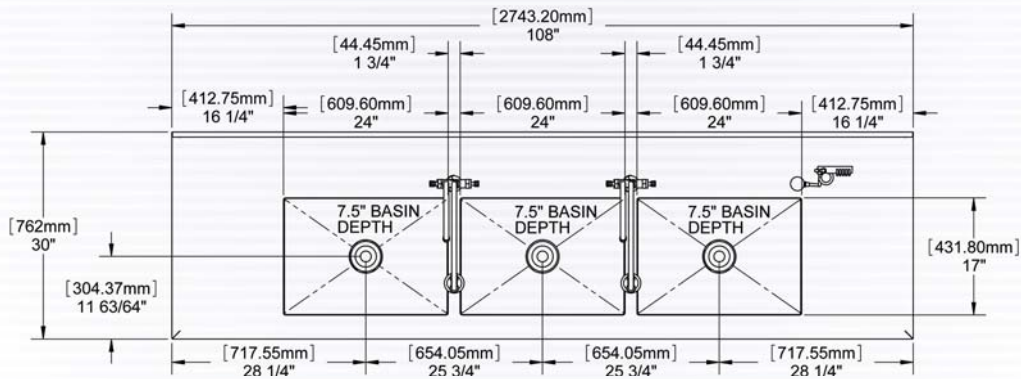
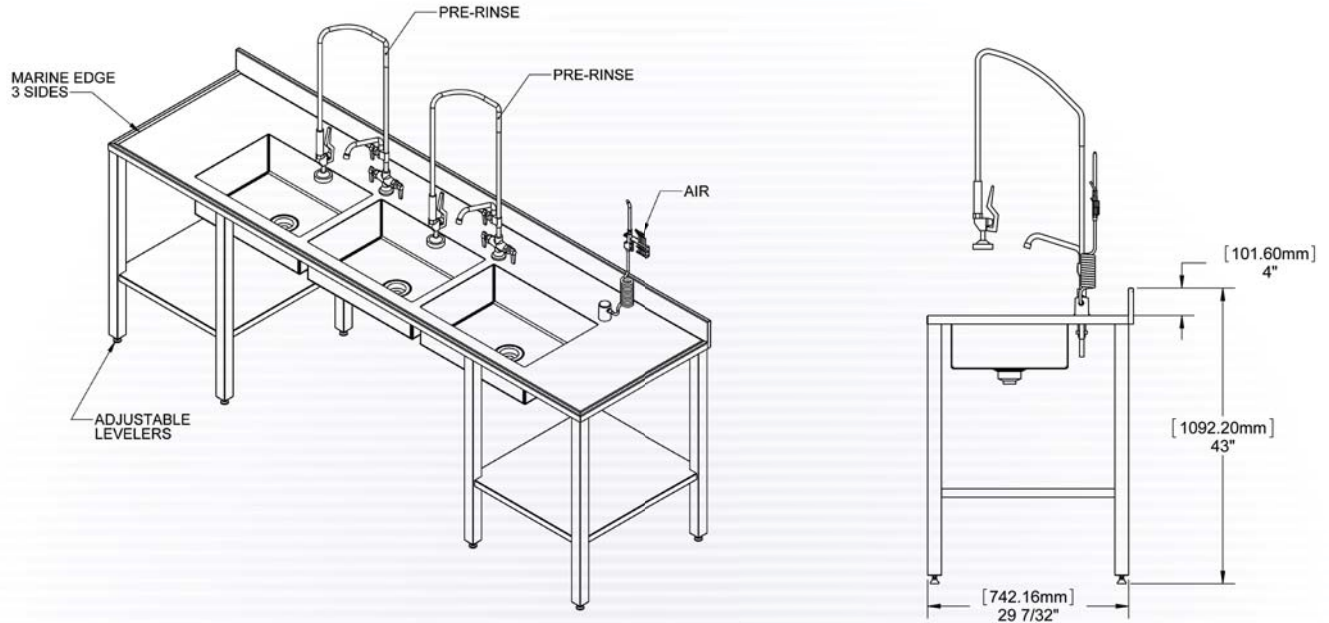

Processing Sinks

Double Processing Sink Drawing Example:

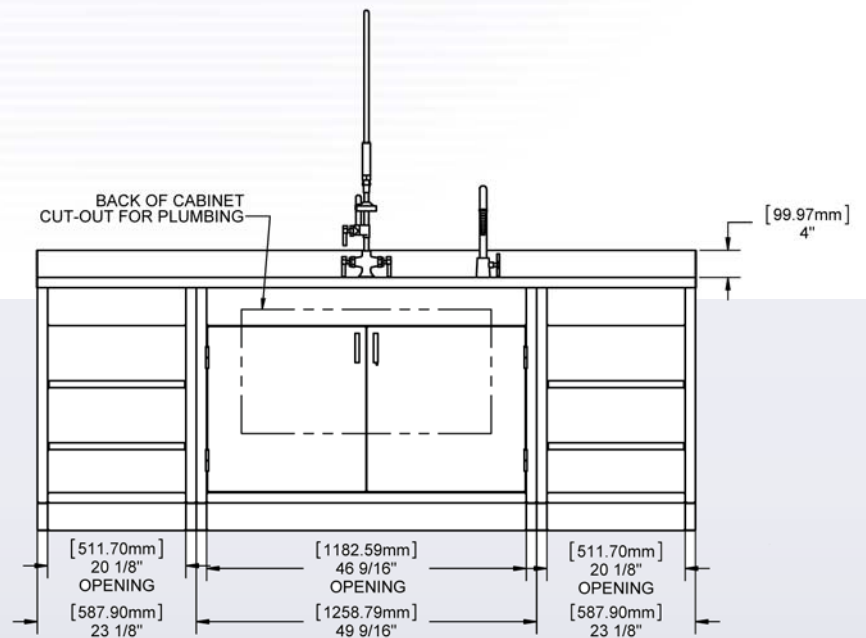
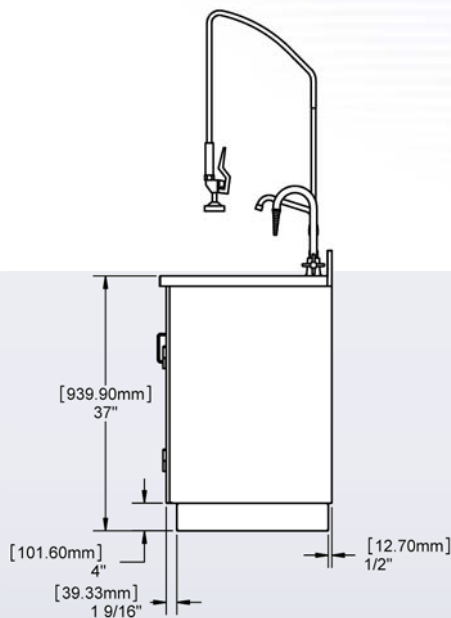
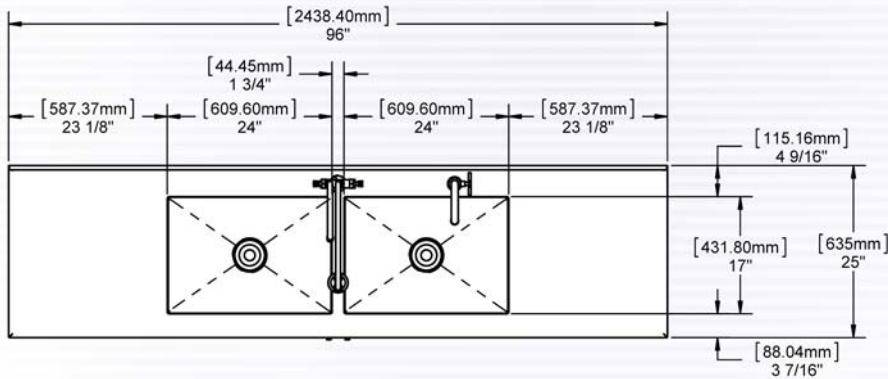
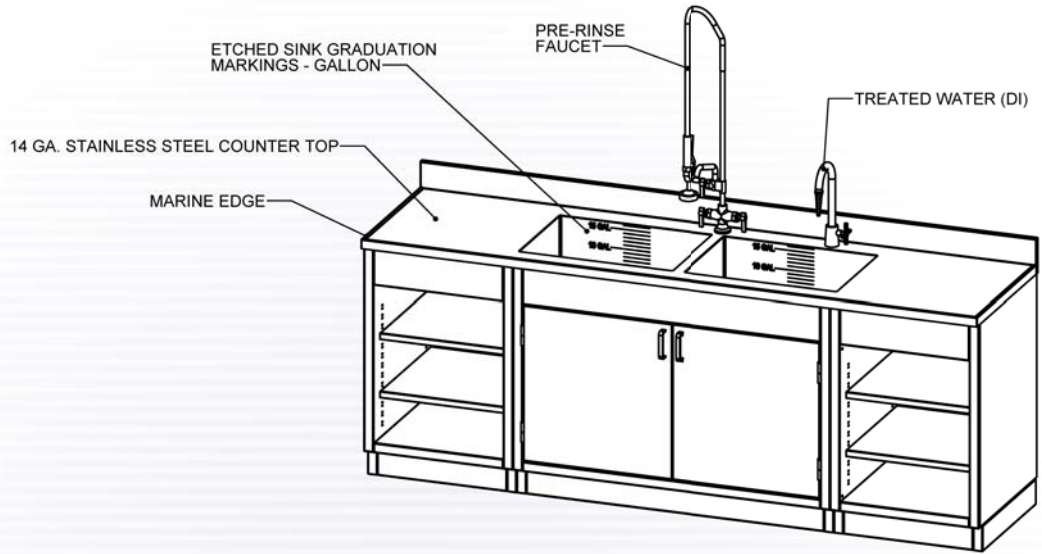

Processing Sinks

Single Processing Sink Drawing Example:

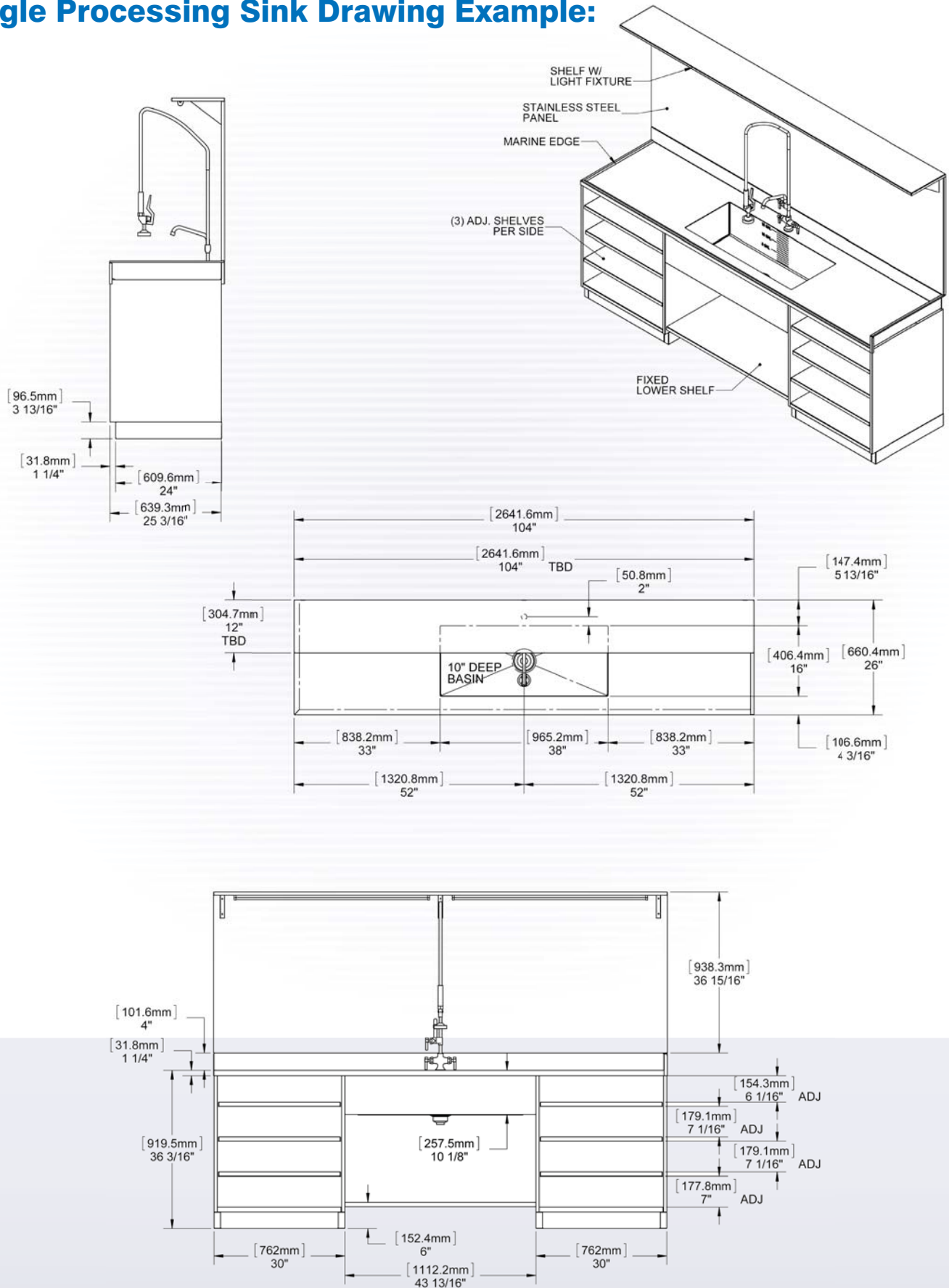

Processing Sinks

Processing Sink Accessories:

Pre-Rinse & Faucet Combo

Our deck mounted pre-rinse & faucet combination option provides convenience and efficiency.

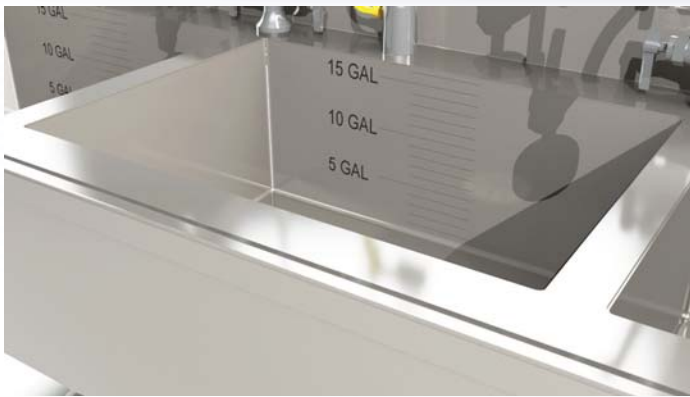

Etched Gallon Markers

With our optional etched gallon markers in the sink, correct mixtures are even easier to maintain.

Drain Lever Handle

A lever handle for the drain, located under the sink, ensures maximum functionality for draining.



Processing Sinks

Processing Sink Accessories:

Air & Water Pistols

The air and water pistol option are essential for thorough cleaning requirements.

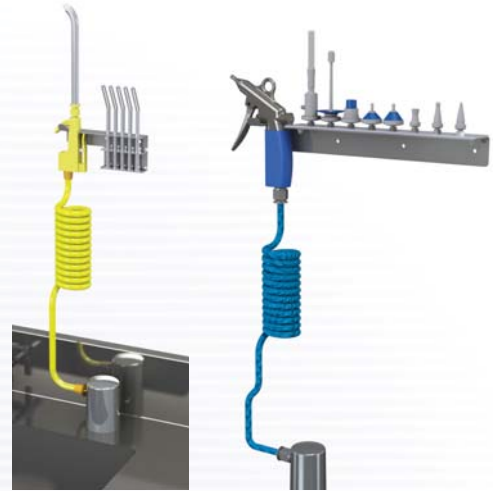

RO Water

RO water completes requirements for the manual cleaning process.

4" Back Splash

Our 4" back splash option gives consumers the most ideal working surface.



Pass-Through Windows

FHC Pass-Through Window:

FHC Pass-Through Window Assembly: Our Pass-Through Windows are designed by your individual specifications. Each Pass-Through Window assembly is **Fully Customized** to adjust to your facilities' available space. The assembly is constructed with fully welded stainless steel, and the thick, tempered glass makes transferring items between decontamination and preparation areas a breeze.

Standard Features:

- **300 series stainless steel welded construction**
- **14 Gauge wall bracket**
- **12 Gauge frame**
- **16 Gauge glass doors**
- **18 Gauge front and back cover**
- **Doors non-locking w/ spring loaded catches**
- **Tempered glass 3/16" thick**
- **Available with or without shelf**



FHCPTW0002

Pass-Through Windows

FHC Pass-Through Window Drawing Example:

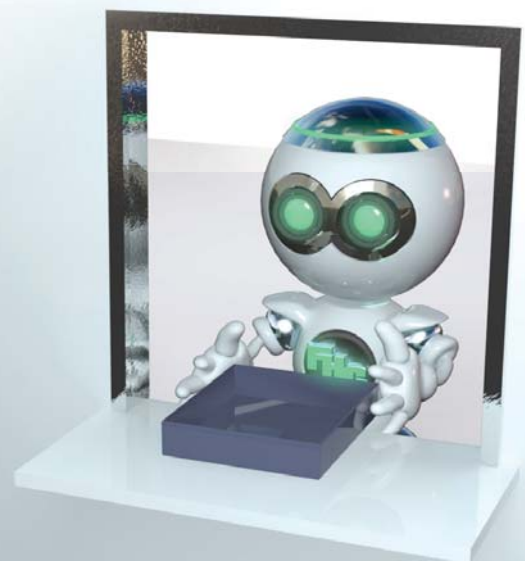
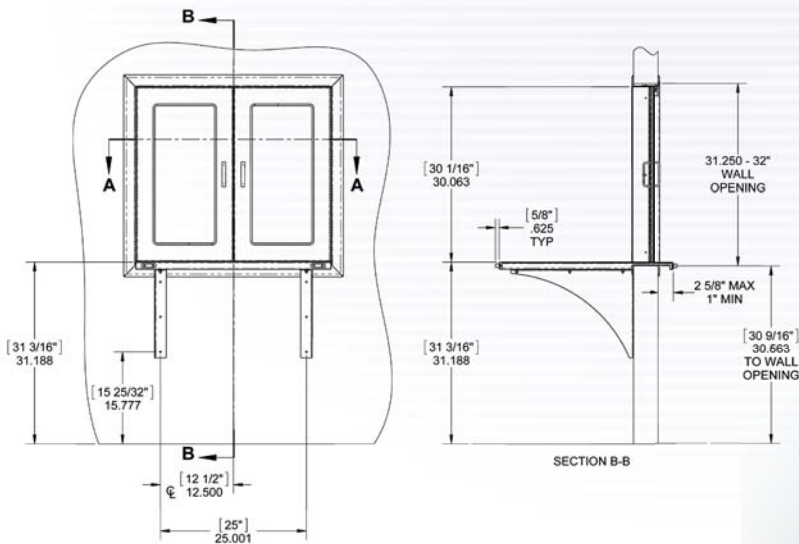
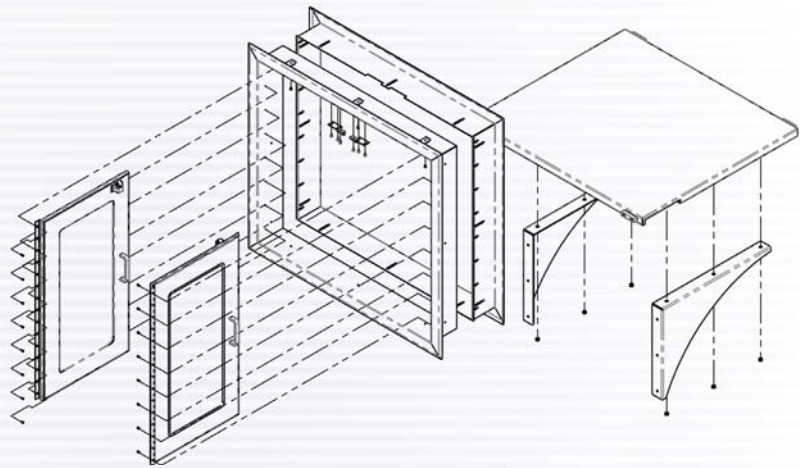
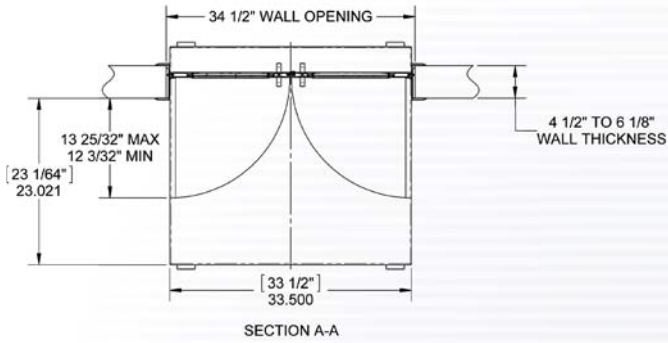

Sterilizers

At Future Health Concepts, we refurbish each and every one of our sterilizers/autoclaves in-house. Built from the chamber up, they come complete with a one year parts and labor warranty (excluding expendable parts for PM purposes).

Standard Features:

- New piping component package
- Renovated pressure chamber
- Radial arm door
- Control column with an easy-to-read vacuum fluorescent display
- Integral thermal printer

Gravity:

The refurbished gravity single door sterilizers are designed for sterilization of liquid in flasks with vented closures at 250°F and also heat-and-moisture stable goods at 270°F.

Prevacuum:

Prevacuum designed for efficiency, high-volume processing of heat-and-moisture-stable materials such as fabrics, wrapped hard goods, glassware at 270°F. Prevacuum units will also run gravity cycles.



FHC-AMSCO3021

Sterilizers

Amsco Century Small Sterilizers:

Standard Features:

- Florescent display for easy reading
- Ink on paper impact printer
- Emergency manual exhaust valve
- Non-lubricated, steam-activated door seal
- Help screens for programming or troubleshooting alarm conditions
- Communication interface compatibility with most PC devices
- Electronic water conservation valve
- Built with easy open vertical door

Model #	Chamber Dimensions
AMSCO Century Small Gravity Series	
FHC-AMSCOG116	16"W x 16"L x 26"D
FHC-AMSCOG120	20"W x 20"L x 38"D

Model #	Chamber Dimensions
AMSCO Century Small Prevac Series	
FHC-AMSCOV116	16"W x 16"L x 26"D
FHC-AMSCOV120	20"W x 20"L x 38"D



FHC-AMSCOV116

DESCAL-A-MATIC

Standard Features:

- Prolongs life of steam generators, heating elements, and many more applications
- Helps to eliminated water quality issues associated and related costs
- Provides a non-chemical, environmentally green water treatment

Extends the life of your sterilizer!



DEDC-6

	DC-1	DC-3	DC-6	DC-12	DC-18	DC-30	DC-36	DC-50
Capacity:								
gpm	1	3	6	12	18	30	36	50
lpm	3.7	11.3	22.7	45.4	68.1	113.5	136.2	189.2
Press Drop:								
PSI	.50	.75	.9	.38	.42	.9	1.46	.97
GM/CM2	35.1	52.7	63.2	26.7	29.5	68.1	102.6	68.1
Weight:								
lbs	2	2	3	5	7	7	10	36
kg	.9	.9	1.4	2.3	3.2	3.2	4.5	16.3
Connect Size:								
A"	3/4"	3/4"	1"	1 1/4"	1 1/2"	1 1/4"	1 1/2"	2 1/2"
Length:								
B" (Inch/MM)	13.5 / 342.9	13.5 / 342.9	14.75 / 374.65	16.75 / 425.45	16.75 / 425.45	22.75 / 577.85	24.5 / 622.3	28 / 711.2

Sterilizers

Amsco Century Medium Sterilizers:

Standard Features:

- Florescent display for easy reading
- Ink on paper impact printer
- Emergency manual exhaust valve
- Non-lubricated, steam-activated door seal
- Help screens for programming or troubleshooting alarm conditions
- Communication interface compatibility with most PC devices
- Electronic water conservation valve

Model #	Chamber Dimensions
---------	--------------------

AMSCO Century Gravity Series

FHC-AMSCOG136	24"W x 36"L x 36"D
FHC-AMSCOG148	24"W x 36"L x 48"D
FHC-AMSCOG160	24"W x 36"L x 60"D

Model #	Chamber Dimensions
---------	--------------------

AMSCO Century Prevac Series

FHC-AMSCOV136	24"W x 36"L x 36"D
FHC-AMSCOV148	24"W x 36"L x 48"D
FHC-AMSCOV160	24"W x 36"L x 60"D



FHC-AMSCOG160



FHC carries a full line of sterilizer parts & supplies to accommodate your sterilization needs!



Sterilizers

Amsco Eagle 3000 Series Sterilizers:

The Eagle 3000 Series Sterilizers feature an advanced microcomputer control system, providing the latest standard for cycle setup, selection and monitoring. Once settings are made and the cycle started, microcomputers accurately monitor and control system operations. The Control Column includes an easy-to-read vacuum fluorescent display and an integral thermal printer.



FHC-AMSCO3021



FHC-AMSCO3053

Model #	Chamber Dimensions
AMSCO Gravity 3000 Series	
FHC-AMSCO3011	16"W x 16"L x 26"D
FHC-AMSCO3021	20"W x 20"L x 20"D
FHC-AMSCO3031	24"W x 36"L x 36"D
FHC-AMSCO3041	24"W x 36"D x 48"D
FHC-AMSCO3051	24"W x 36"D x 60"D

Model #	Chamber Dimensions
AMSCO Prevacuum 3000 Series	
FHC-AMSCO3013	16"W x 16"L x 26"D
FHC-AMSCO3023	20"W x 20"L x 20"D
FHC-AMSCO3033	24"W x 36"L x 36"D
FHC-AMSCO3043	24"W x 36"L x 48"D
FHC-AMSCO3053	24"W x 36"L x 60"D

Sterilizers

Our refurbishing process begins in our 25,000+ sq. ft. facility, where we follow over 820 guidelines and GMP standards.

Step 1:



First, we take apart all the equipment and thoroughly inspect for any defects.

Step 2:



Next, every nut and bolt is taken out of the sterilizer and cleaned up or replaced along with a brand new piping package.

Sterilizers

We supply various chamber sizes, door styles, and double door units for your sterilization needs!

Step 3:



Then, all panels are painted to mint condition placed on the sterilizer.

Step 4:



Finally, the sterilizer goes through performance tested to meet original manufacturer's specifications.

Tabletop Sterilizers

SciCan Statim G4 Cassette Sterilizers

Statim 2000 G4



SC01-121101

Statim 5000 G4



SC01-201104

Cycle	Unwrapped	Wrapped	Rubber/Plastic	Heavy Duty Unwrapped / Air Drying
STATIM 2000 G4				
Sterilization time	3.5 minutes	10 minutes	15 minutes	Air drying only
Sterilization Temp	135°C	135°C	121°C	Air drying only
Total Cycle time*	6 minutes	14 minutes	20 minutes	Air drying only
STATIM 5000 G4				
Sterilization time	3.5 minutes	6 minutes	35 minutes	6 minutes
Sterilization Temp	132°C	132°C	121°C	132°C
Total Cycle time*	9 minutes	17.5 minutes	45 minutes	12 minutes

*Cycle time is dependent on instrument load.

STATIM 2000 G4

Unit size (L x W x H): 19.5" x 16.25" x 6" or 49.5 cm x 41.5 cm x 15 cm
 Cassette internal dimensions: 11" x 7" x 1.4" or 28 cm x 18 cm x 3.5 cm
 Weight without water: 46 lbs/21 kg
 Power consumption: 115 V, 50/60 Hz, 15A / 1450 W

STATIM 5000 G4

Unit size (L x W x H): 23.6" x 16.1" x 7.5" or 60 cm x 41 cm x 19 cm
 Cassette internal dimensions: 15" x 7" x 3" or 38 cm x 18 cm x 7.5 cm
 Weight without water: 73 lbs/33 kg
 Power consumption: 115 V, 50/60 Hz, 15A / 1450 W



Access your STATIM G4 via your PC network portal



3.5" 65k color touchscreen provides a wealth of information



The G4 is capable of communicating directly with service personnel



Recommended essential STATIS® instrument system



Wrapped dental headpieces in the STATIM 5000 G4 cassette



Wrapped dental headpieces in the STATIM 2000 G4 cassette



Dri-Tec[®] – Convection Heat Drying Technology

The STATIM 2000 G4 uses convection heat to dry instruments by utilizing the remaining heat in the system after the sterilization phase. Heat is captured and released into the cassette, drying wrapped instrument loads in as little as 10 minutes.



Dri-Tec[®] – Radiant Heat Drying Technology

The STATIM 5000 G4 uses heat generated by the sterilization cycle which is 'absorbed' by unique drying plates located in the sterilization chamber. Heat is transferred from the drying plates directly to instruments resulting in accelerated, full load drying in as little as 15 minutes.

Tabletop Sterilizers

SciCan Bravo Chamber Sterilizers

Standard Features:

- Pre-vac & post-vac cycle
- Dri-Tec drying system technology
- 4 pre-set cycles
- Single button initiation
- Quick start-up time
- Self diagnostic
- Optional integrated storage system (comes standard w/ BRAVO 21V)



BRAVO 17V (110V)
SCBRAVO-17V



BRAVO 21V (220V)
SCBRAVO-21V



Dryness

With closed door drying and the Dri-Tec[®] drying system, the BRAVO gives you lightning fast & consistent dry loads every time to allow more loads to be processed daily.

Cycles (134°C @ 4 mins.)	17V		21V		Max. Load Weight	
	Cycle times (include drying**)		17V	21V	17V	21V
Porous (handpieces) / Wrapped	35 mins.	40 mins.	*	*		
Hollow (handpieces) / Unwrapped	27 mins.	32 mins.	6kg / 13.6lbs	7.5kg / 16.5lbs		
Solid / Wrapped	24 mins.	28 mins.	3kg / 6.6lbs	4.0kg / 8.8lbs		
Solid / Unwrapped	19 mins.	23 mins.	6kg / 13.3lbs	7.5kg / 16.5lbs		

* 17V/ 21V: Unpackaged porous materials:1kg/1.25kg, Porous material in single package: 0.75kg / 1.0kg, Solid material/hollow instruments in single pack: 3kg/4kg, Solid material/hollow instruments in double package:1.5kg / 2.0kg.
**Note: Cycle times represent 220V models

Model	Size L x W x H†	Volume	Chamber Dimension	Weight	Voltage
BRAVO 17V	22.0 x 19.0 x 16.5" 560 x 480 x 420mm	4.5 gal / 17L	D10 x L13.5" D254 x L343mm	128lbs / 55kg	120V, 20A
BRAVO 21V	25.0 x 19.0 x 16.5" 635 x 480 x 420mm	5.5 gal / 21L	D10 x L17.5" D254 x L445mm	139lbs / 63kg	220V, 10A

Top filling port on BRAVO 21V



Rear mounted, direct-to-drain exhaust port



BRAVO 21 clean water exhaust port for servicing

Used water exhaust port

Clean water filling port

Tabletop Sterilizers







Tuttnauer EZ+Series Fully Automatic Autoclaves



TUEZ9plus

TUEZ11plus

Tuttnauer EZ Plus Sterilization Programs:

Sterilization programs		Temp.	Hot Cycle Time (fill, heat up and vent)	Sterilization Time (minutes)	Dry Time* (minutes)	Total Hot Cycle Time (Without Dry)	Total Hot Cycle Time (With Dry)
Description	Icon						
Unwrapped Instruments		270°F	EZ9PLUS: 20min. EZ11PLUS: 24min.	3	1	EZ9PLUS: 23min. EZ11PLUS: 27min.	EZ9PLUS: 24min. EZ11PLUS: 28min.
Wrapped Instruments, Pouches		270°F	EZ9PLUS: 17min. EZ11PLUS: 21min.	4	30	EZ9PLUS: 21min. EZ11PLUS: 25min.	EZ9PLUS: 51min. EZ11PLUS: 55min.
Unwrapped Delicate Instruments		250°F	EZ9PLUS: 16min. EZ11PLUS: 19min.	30	1	EZ9PLUS: 46min. EZ11PLUS: 49min.	EZ9PLUS: 47min. EZ11PLUS: 50min.
Handpieces		270°F	EZ9PLUS: 21min. EZ11PLUS: 26min.	4	30	EZ9PLUS: 25min. EZ11PLUS: 30min.	EZ9PLUS: 55min. EZ11PLUS: 60min.
Chamber Brite Cleaning		270°F	EZ9PLUS: 17min. EZ11PLUS: 20min.	3(keep temperature)	N/A	EZ9PLUS: 20min. EZ11PLUS: 23min.	EZ9PLUS: N/A EZ11PLUS: N/A
Custom A**		270°F	EZ9PLUS: 20min. EZ11PLUS: 22min.	4	30	EZ9PLUS: 24min. EZ11PLUS: 26min.	EZ9PLUS: 54min. EZ11PLUS: 56min.
Custom B**		250°F	EZ9PLUS: 13min. EZ11PLUS: 16min.	30	1	EZ9PLUS: 43min. EZ11PLUS: 46min.	EZ9PLUS: 44min. EZ11PLUS: 47min.

* Operator has the option to add additional drying time.

** Custom A and Custom B programs are not FDA cleared. It is the user's responsibility to validate any Custom cycles.

NOTE: cycle times are approximate and may vary depending on instrument loads.

Tabletop Sterilizers

Tuttnauer EZ Plus Features & Specifications

Technical Specifications

Item No.	Chamber Dimensions Ø x L in (mm)	Volume	Overall Dimensions* DxWxH in (mm)	Standard Cassette Capacity **	Tray Dimensions DxWxH in (mm)	No. of Trays	Voltage (V) Freq. (Hz)	Power (W) Current (A)	Shipping Weight lbs (kg)
EZ9Plus	9"x19.8" (230x504)	5.2gal 19.8L	24.8"x19.1"x15.1"* (630x485x384)	2 Full & 2 Half** (loaded horizontally)	16.3"x6.7"x0.6" (413x169x16)	3	120V 50/60	1400W 12A	104(47)
EZ11Plus	11"x19.8" (280x504)	7.5gal 28.5L	24.8"x20.9"x17.3"* (630x530x440)	4 Full & 4 Half** (loaded vertically)	16.3"x6.7"x0.6" (413x169x16)	5	120V 50/60	1400W 12A	122(56)

* Models EZ9Plus and EZ11Plus require a minimum tabletop depth of 22".

**Standard full size cassette is 8" x 11" and standard half size cassette is 8" x 5.5".

EZGlide self locking door

Newly designed, ergonomically friendly EZGlide door features effortless opening and closing with an automatic double safety locking mechanism. Glide the door closed with a gentle push to close and lock it.



EZfill front water filling
Accessible front or top water filling options

EZView multi-color display
For easy reading, even from a distance

Capacity
Available in 9" and 11" chamber sizes

Network port (rear located)
For connection to a local network to provide remote monitoring of the system

Comprehensive warranty
2 year parts and labor and 10 year chamber warranty



TUEZ11plus

Standards and directives

Designed to meet the most current sterilization standards ANSI/AAMI ST55

Closed door drying

Door remains closed *through* the dry cycle to maintain sterility and ensure efficient drying. High efficiency air pump circulates filtered air through the chamber for fast drying. 0.2µm HEPA air filter (replaceable).

Dynamic air removal technology

Effectively removes air from the chamber

Tabletop Sterilizers

Tuttnauer EZ Series Fully Automatic Autoclaves



TUEZ9



TUEZ10

EX9™ and EX10™ Series:

Item No.	Chamber Dimensions Ø x L In(mm)	Volume	Overall Dimensions DxWxH In(mm)	Standard Cassettes	Tray Dimensions DxWxH In(mm)	No. of Trays	Standard Unwrapped Cycle time	Voltage(V) Freq.(Hz)	Power(W) Current(A)	Shipping Weight lbs(kg)
EZ9™	9" x 18" (230 x 470)	5gal/19L	21.5"x20"x14.4" (545x510x365)	2 full/2 half	16.3"x6.7"x0.8" (415x170x20)	3	Cold: 27 mins Hot: 13 mins	120V 50/60	1400W 12A	95 (43)
EZ10™	10" x 19" (254 x 475)	6gal/23L	21.5"x20"x14.4" (545x510x365)	3 full/3 half	16.3"x6.7"x0.8" (415x170x20)	4	Cold: 30 mins Hot: 14 mins	120V 50/60	1400W 12A	95 (43)
*EZ10k™ Kwiklave™	10" x 19" (254 x 475)	6gal/23L	21.5"x20"x14.4" (545x510x365)	3 full/3 half	16.3"x6.7"x0.8" (415x170x20)	4	Cold: 21 mins Hot: 11 mins	230V 50/60	2200W 10A	95 (43)

*Model EZ10k™ requires a voltage between 220V and 235V for proper operation. When applicable a buck/boost transformer (0.5KVA) may be required.

Features:

- Closed door active drying system to maintain sterility and ensure efficient drying of packs and pouches
- High efficiency air pump circulates air in chamber during drying cycle
- 0.2µm Hepa air filter (replaceable)
- New brighter and easier to read panel
- Program parameters can be customized and stored

Control Panel:



1. Program Selection
2. Detailed Digital Display
3. Programmable Keys
4. System Indicators

Optional Internal Printer



Documents:
date, time,
temperature,
pressure.

TUCB0010



Also Available:

Chamber Brite Autoclave Cleaner

- Pre-measured packets
- Cleans reservoir, chamber & tubing

Tabletop Sterilizers

Tuttnauer Manual Autoclaves

Tuttnauer manual autoclaves will compliment any healthcare facility and satisfy all of your sterilization needs. The bright, new, easy to use panel was designed with the operator in mind. Time tested reliability and durability are built into every Tuttnauer product.

FEATURES:

- Automatic shut off at the end of both the sterilization and dry cycles.
- A long life electro polished chamber and door.
- Double safety locking device prevents door from opening while chamber is pressurized.
- Drain valve is located on the front, allowing for quick and easy draining of water reservoir.
- Dual safety thermostat to protect against overheating.
- International certifications.
- 1 year parts and labor warranty.



- 1 Pressure Gauge
- 2 Timer
- 3 Thermostat
- 4 Function Selector

M Series

Item No.	Chamber Dimensions Ø x L in(mm)	Volume	Overall Dimensions DxWxH in(mm)	Standard Cassette Capacity	Tray Dimensions DxWxH in(mm)	No. of Trays	Standard Unwrapped Cycle Time	Voltage(V) Freq.(Hz)	Power(W) Current(A)	Shipping Weight lbs(kg)
2340M	9" x 18" (230 x 470)	5gal/19L	21.5"x20"x14.4" (545x510x365)	2 full and 2 half	16.3"x6.7"x0.8" (415x170x20)	3	Cold: 27 mins Hot: 13 mins	120V 50/60	1400W 12A	85 (39)
2540M	10" x 19" (254 x 475)	6gal/23L	21.5"x20"x14.4" (545x510x365)	3 full and 3 half	16.3"x6.7"x0.8" (415x170x20)	4	Cold: 30 mins Hot: 14 mins	120V 50/60	1400W 12A	85 (39)

Manual Kwiklave™ MK Series

2540MK	10" x 19" (254 x 475)	6gal/23L	21.5"x20"x14.4" (545x510x365)	3 full and 3 half	16.3"x6.7"x0.8" (415x170x20)	4	Cold: 21 mins Hot: 11 mins	230V 50/60	2200W 10A	85 (39)
--------	--------------------------	----------	----------------------------------	-------------------	---------------------------------	---	-------------------------------	---------------	--------------	------------

The Tuttnauer M Series is also available in a quick cycle model, the Kwiklave (MK). This sterilizer offers all the proven, dependable features of our manual autoclave, with the added benefit of reducing the total heat up time. This autoclave is the perfect choice for quick instrument turnaround or a high volume office. Speed and reliability are accomplished without sacrificing load size. 1 year parts and labor warranty.

Model 2540MK requires a voltage between 220V and 235V for proper operation. When applicable a buck/boost transformer (0.5KVA) may be required.

Large Capacity Manual Autoclave

Our largest manual tabletop autoclave. Perfect for multi-doctor practices, clinics or surgery centers. 15" x 30" chamber accommodates longer instruments or a large number of small instruments. Capacity for 15 full size IMS cassettes. 1 year parts and labor warranty.



Item No.	Chamber Dimensions Ø x L in(mm)	Volume	Overall Dimensions DxWxH in(mm)	Standard Cassette Capacity	Tray Dimensions DxWxH in(mm)	No. of Trays	Standard Unwrapped Cycle Time	Voltage(V) Freq.(Hz)	Power(W) Current(A)	Shipping Weight lbs(kg)
3870M	15" x 30" (384 x 760)	22gal/85L	34.5"x26"x20.6" (875x665x525)	15 full	26.6"x11.3"x1" (675x286x25) 26.6"x13.8"x1" (675x350x25)	2	Cold: 32 mins Hot: 23 mins	230V 50/60	3000W 13.6A	209 (95)

All published cycle times are estimated. Actual times may vary depending on load size and voltage.

Ultrasonic Cleaners

Ultrasonic Cleaning Systems



TUCSU1

TUCSU3

Available accessories

System Specifications:		CSU1	CSU3
Tank Dimensions	W	9 3/8 (23.8)	15 1/2 (39.4)
	H	4 (10.2)	6 (15.2)
	D	5 3/8 (13.7)	9 (22.9)
External Dimensions	W	12 5/8 (32)	19 (48.3)
	H	8 3/4 (22.2)	13 1/2 (34.3)
	D	9 7/8 (25)	16 (40.6)
Tank Capacity	Gallons (Liters)	0.8 (3.4)	3 (12.7)

Tuttnauer's Clean & Simple Ultrasonic Cleaning Systems are manufactured with only the highest quality components. These machines provide 60 kHz of quiet cleaning power which is less aggressive to instruments while still removing all surface contamination. The contemporary design and quiet operation compliments any office environment. Clean & Simple Ultrasonic Systems are available in 2 sizes with a full selection of accessories to meet your specific needs. The 1 gallon system holds a standard selection of instruments or 2 half size cassettes. The 3 gallon system holds 3 full size cassettes. Both sizes are available with an optional heater.

FEATURES:

- High efficiency 60 kHz of cavitation for a thorough and quieter cleaning.
- Durable vinyl clad steel housing... easy to clean and resists scratching.
- Stainless steel tank with cover.
- Full line of accessories available.

Ultrasonic Cleaning Tablets

Clean & Simple is an ultrasonic / enzymatic solution dispensed in a unique tablet form. Drop 2 tablets into your ultrasonic tank already filled with tap water and the tablets will dissolve in about a minute. This is a non-ionic solution which is non-corrosive, non-toxic, biodegradable and non-caustic. Available in boxes of 64 tablets, Item No. CS0064 and 144 tablets, Item No. CS0144.

FEATURES:

- Easy to use tablet form.
- Eliminates handling of heavy 1 gallon containers.
- No bulky storage.
- No pre-mixing required.
- Enzymatic solution effectively breaks down protein.



TUCS0144

Ultrasonic Cleaners

The FHC Cavitator Ultrasonic Cleaners come in 5 different sizes, designed to fit your cleaning needs. These cleaners generate ultrasonic waves that create millions of tiny bubbles through the process of cavitation. The bubbles gently clean and polish any surface they come in contact with, penetrating every nook and cranny to dislodge trapped dirt and debris. Medical instruments, glassware, even jewelry are quickly restored to their original lustrous finish without expending any effort. The gentle cleaning action is ideal for delicate items, too.



Specifications:

Model	2.1	4.6	11	5.5S	18
Capacity	2.1 quarts (2 liters)	4.6 quarts (4.3 liters)	11 quarts (10.4 liters)	5.5 gallons (20.8 liters)	18 gallons (68 liters)
Outside Dimensions					
L x W x H					
inches	10 3/8 x 6 3/8 x 5 11/16	10 3/8 x 6 3/8 x 9 1/8	12 3/4 x 10 1/2 x 9	21 1/2 x 13 1/2 x 11 1/4	23 3/4 x 17 3/4 x 31
cm	26.4 x 16 x 14.4	26.4 x 16.2 x 23.2	32.4 x 26.7 x 22.9	54.6 x 34.3 x 28.6	60.3 x 45.1 x 78.7
Tank Size					
L x W x H					
inches	9 3/8 x 5 3/8 x 2 5/16	9 3/8 x 5 3/8 x 6	11 3/4 x 9 1/2 x 6	19 1/2 x 11 1/2 x 6	21 3/4 x 15 3/4 x 12
cm	23.8 x 13.7 x 5.9	23.8 x 13.7 x 15.2	29.8 x 24.1 x 15.2	49.5 x 29.2 x 15.2	55.2 x 40 x 30.5
Power Requirements	105/120 VAC 50/60 Hz	105/120 VAC 50/60 Hz	105/120 VAC 50/60 Hz	105/120 or 220 VAC 50/60 Hz	105/120 or 220 VAC 50/60 Hz
Power	85 watts	85 watts	200 watts	200 watts	800 watts
Nominal Main Frequency	67 KHz	67 KHz	67 KHz	67 KHz	24 KHz
Standard Accessories			Drain hose	Drain hose, Cleaning basket	Drain hose, Cleaning basket Fill hose, #1159



Covers

- ME1012 Stainless steel cleaning baskets (fits ME11)
- ME1025 Stainless steel cleaning baskets (fits either ME2.1 or ME4.6)
- ME1038 Stainless steel cleaning basket (fits ME5.5S)



Cleaning Baskets

- ME1011 Stainless steel cleaning baskets (fits ME11)
- ME1055 Stainless steel cleaning baskets (fits ME5.5S)
- ME1058 Stainless steel cleaning basket (fits either ME2.1 or ME4.6)
- ME1059 Stainless steel cleaning basket (fits ME18)

Steam Generators

RB10 - RB30 Steam Generator Series:

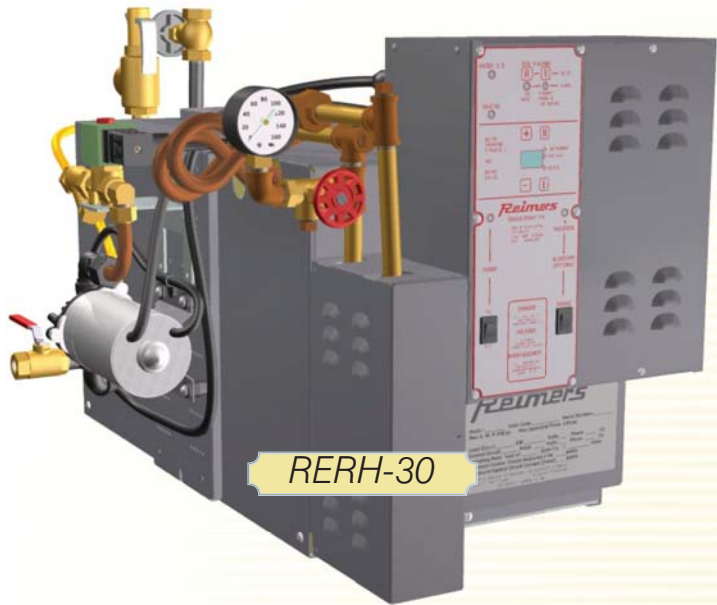

- Miniature generators max. vessel volume 1.5ft³
- Maximum safety valve setting 100psi
- Manufactured in accordance with requirements of the A.S.M.E. Boiler and Pressure Vessel Code and A.S.M.E. CSD-1. Each generators bears the National Board Stamp "M".
- Dry sat. steam, operating pressure range 0 - 85psi
- Very compact design, all controls accessible from generators front
- Suitable for installation in tight spaces like autoclaves
- Heavy duty carbon steel pressure vessel
- Vessel jacket and electrical enclosure 316 stainless
- Large selection of optional equipment

Generator standard equipment includes: Low water cut off control with manual reset, high pressure cutoff control with manual reset, one operating pressure control, high water cut-off control with automatic or manual reset, pressure gauge and safety valve.

RB-SERIES Steam Boilers									
KW	LB/HR	BHP	VOLTAGE*	PHASE	SHIP WT. LB	OP. PRESS. RANGE	MBTU/HR	Steam Outlet (NPT)	
								LP	HP
10 KW	34	1.0	208/240**/380/415/480/600	3	172	0-85 PSIG	34	3/8	3/8
18 KW	62	1.8	208/240**/380/415/480/600	3	172	0-85 PSIG	61	3/8	3/8
20 KW	69	2.0	208/240**/380/415/480/600	3	172	0-85 PSIG	68	3/8	3/8
30 KW	104	3.0	208/240**/380/415/480/600	3	172	0-85 PSIG	101	3/8	3/8

*Each generators model requires two power supplies: Primary heating power and secondary control voltage. Nominal control voltage is 120V, 50/60Hz. When generator equipped with transformer option, only heating power supply required.

**Also available in 240V 1PH

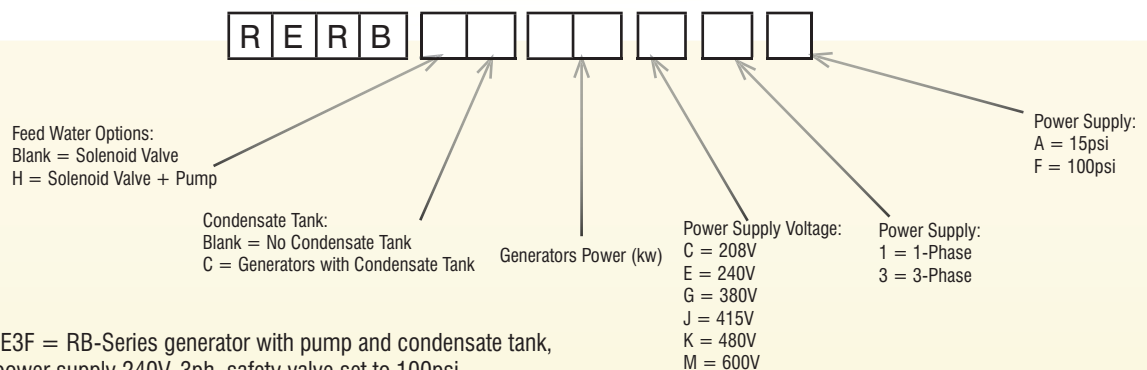

Example: RERBHC20E3F = RB-Series generator with pump and condensate tank, 20kw heating power, power supply 240V, 3ph, safety valve set to 100psi

Steam Generators

RX36 - RX120 Steam Generator Series:



RERH-36

- Miniature generators max. vessel volume 5ft³
- Maximum safety valve setting 100psi
- Manufactured in accordance with requirements of the A.S.M.E. Boiler and Pressure Vessel Code and A.S.M.E. CSD-1. Each generators bears the National Board Stamp "M".
- High quality saturated steam, operating pressure range 0-85psi
- Heavy duty carbon steel pressure vessel
- Vessel jacket and electrical enclosure 316 stainless
- Large selection of optional equipment

Standard Equipment of Each Generator Includes:

- A.S.M.E pressure relief valve
- High pressure cutoff control with manual reset
- One operating pressure control for all models equipped with two heating elements or two staged operating pressure controls for all models equipped with three or four heating elements
- Low water cutoff control with manual reset
- High water cut-off control with automatic or manual reset.
- Magnetic contactors
- Internal branch circuitry fusing
- Enable/Disable switch for each heating element
- Main supply power distribution block
- Indicator lights for Power, Refilling, Heating, and Alarms

(1) Each Generators model requires two power supplies: Primary heating power and secondary control voltage. Nominal control voltage is 120V, 50/60Hz. When generator equipped with transformer option, only heating power supply required. Generator models rated for 380V and 415V are equipped with control voltage transformers that require 220/240V applied to primary side to provide 120V AC control voltage to generator. As an option, models can be equipped with control voltage transformers so only heating power supply needs to be connected to generator.

(2) Also available in 240V 1PH

(3) On boiler equipped with condensate tank, add 150 lbs to shipping weight.

(4) Steam Capacity listed below based on evaporation rate from 212°F at 0 psig. If generator feed water temperature is 50°F, then Steam Capacity for model listed is approx. 15% lower

(5) RX100 model, rated 208V, 3ph limited to 307lbs/hr, 90kw, 9BHP

HEATING POWER kW	STEAM CAPACITY lbs/hr (kg/hr) ⁽⁴⁾	BHP	VOLTAGE ⁽¹⁾	PHASE	SHIP WT. ⁽³⁾ Lbs (kg)	OP. PRESS. RANGE psig (bar)	Steam Outlet (NPT)	
							LP < 15psig	HP > 15psig
36 KW	123 (56)	3.6	208/240/480/600	3 ⁽²⁾	480 (218)	0-85 (0 - 5.9)	1	3/4
40 KW	137 (62)	4.0	208/240/380/415/480/600	3	480 (218)	0-85 (0 - 5.9)	1	3/4
45KW	154 (70)	4.5	208/240/380/415/480/600	3	530 (240)	0-85 (0 - 5.9)	1-1/4	3/4
54 KW	185 (84)	5.4	208/240/480/600	3	530 (240)	0-85 (0 - 5.9)	1-1/4	3/4
60 KW	205 (93)	6.0	208/240/380/415/480/600	3	530 (240)	0-85 (0 - 5.9)	1-1/4	1
72 KW	246 (111)	7.2	208/240/480/600	3	610 (276)	0-85 (0 - 5.9)	1-1/4	1
80 KW	273 (124)	8.0	208/240/380/415/480/600	3	610 (276)	0-85 (0 - 5.9)	1-1/4	1
100 KW	342 (155)	10.0	208 ⁽⁵⁾ /240/380/415/480/600	3	795 (360)	0-85 (0 - 5.9)	2	1-1/4
120 KW	409 (185)	12.0	208/240/380/415/480/600	3	795 (360)	0-85 (0 - 5.9)	2	1-1/4

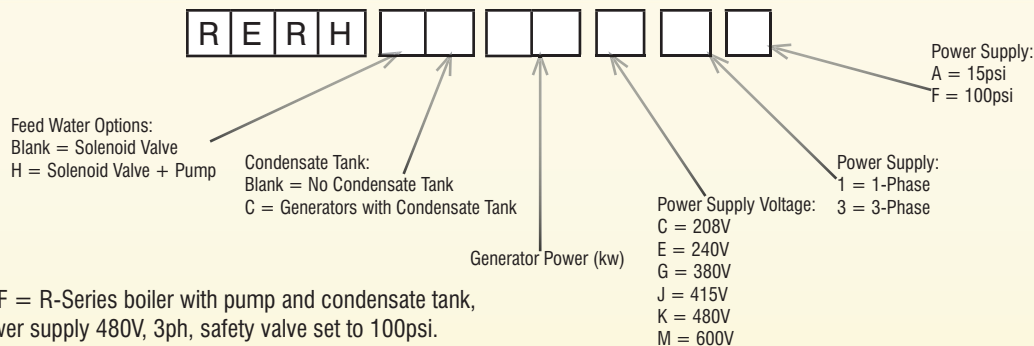

Example: RERHHC120K3F = R-Series boiler with pump and condensate tank, 120kW heating power, power supply 480V, 3ph, safety valve set to 100psi.

Steam Generators

RHP120 - RHP300 Steam Generator Series:



- Maximum safety valve setting 150psi
- Manufactured in accordance with requirements of the A.S.M.E. Boiler and Pressure Vessel Code and A.S.M.E. CSD-1. Each generators bears the National Board Stamp "M".
- Dry saturated steam, operating pressure range 0-135psi
- Heavy duty carbon steel pressure vessel
- Vessel jacket and electrical enclosure 316 stainless
- Large selection of optional equipment

Generator standard equipment includes: Primary low water cutoff control with automatic reset, secondary low water cut off with manual reset, safety relief valve, pressure gauge, one primary high pressure cutoff control with automatic reset, one secondary high pressure control with manual reset and PID-step control with number of heating stages depending on boiler size.

RHP SERIES LOW & HIGH PRESSURE STEAM BOILERS									
KW	STEAM LB/HR	BHP	VOLTAGE*	PHASE	NUMBER OF HEATING STAGES	SHIP WT. ** LB	OP. PRESS. RANGE	BTU/HR	Steam Outlet (NPT)
120 KW	418	12	240/380/415/480/600	3	4	1,370	0-135 PSIG	409,440	1-1/4"
150 KW	522	15	240/380/415/480/600	3	5	1,370	0-135 PSIG	511,800	1-1/4"
180 KW	626	18	240/380/415/480/600	3	6	1,370	0-135 PSIG	614,160	1-1/4"
210kW	730	21	240/380/415/480/600	3	6	1,370	0-135 PSIG	716,520	1-1/4"
240kW	835	24	380/415/480/600	3	6	1,450	0-135 PSIG	818,880	2"
300kW	1044	30	380/415/480/600	3	6	1,500	0-135 PSIG	1,023,600	2"

*Each generators model requires two power supplies: Primary heating power and secondary control voltage. Nominal control voltage is 120V, 50/60Hz. When generator equipped with transformer option, only heating power supply required.

**Shipping weight for models with feed water solenoid. For models with feed water solenoid + pump and pump + condensate tank.

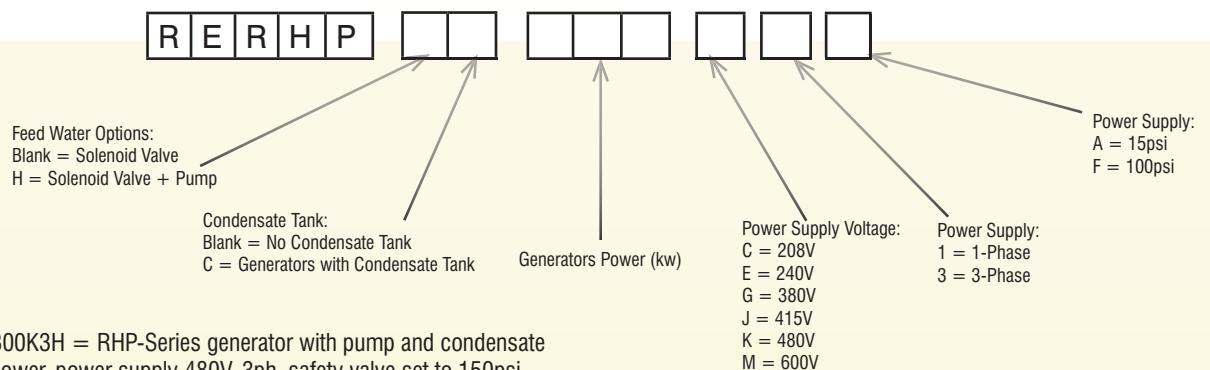

Example: RERHPHC300K3H = RHP-Series generator with pump and condensate tank, 300kw heating power, power supply 480V, 3ph, safety valve set to 150psi.

Steam Generators

RHP600 - RHP750 Steam Generator Series:



- Maximum safety valve setting 150psi
- Manufactured in accordance with requirements of the A.S.M.E. Boiler and Pressure Vessel Code and A.S.M.E. CSD-1. Each generators bears the National Board Stamp "M".
- Dry saturated steam, operating pressure range 0-135psi
- Heavy duty carbon steel pressure vessel
- Vessel jacket and electrical enclosure 316 stainless
- Large selection of optional equipment

Generator standard equipment includes: Primary low water cutoff control with automatic reset, secondary low water cut off with manual reset, safety relief valve, pressure gauge, one primary high pressure cutoff control with automatic reset, one secondary high pressure control with manual reset and PID-step control with number of heating stages depending on boiler size.

RHP SERIES LOW & HIGH PRESSURE STEAM BOILERS

KW	STEAM LB/HR	BHP	VOLTAGE*	PHASE	NUMBER OF HEATING STAGES	SHIP WT. ** LB	OP. PRESS. RANGE	BTU/HR	Steam Outlet (NPT)
600 KW	2,086	60	380/415/480/600	3	10	2,640	0-135 PSIG	2,047,200	3"
750 KW	2,608	75	380/415/480/600	3	12	2,640	0-135 PSIG	2,559,000	3"

*Each generators model requires two power supplies: Primary heating power and secondary control voltage. Nominal control voltage is 120V, 50/60Hz. When generator equipped with transformer option, only heating power supply required.

**Shipping weight for models with feed water solenoid. For models with feed water solenoid + pump and pump + condensate tank.

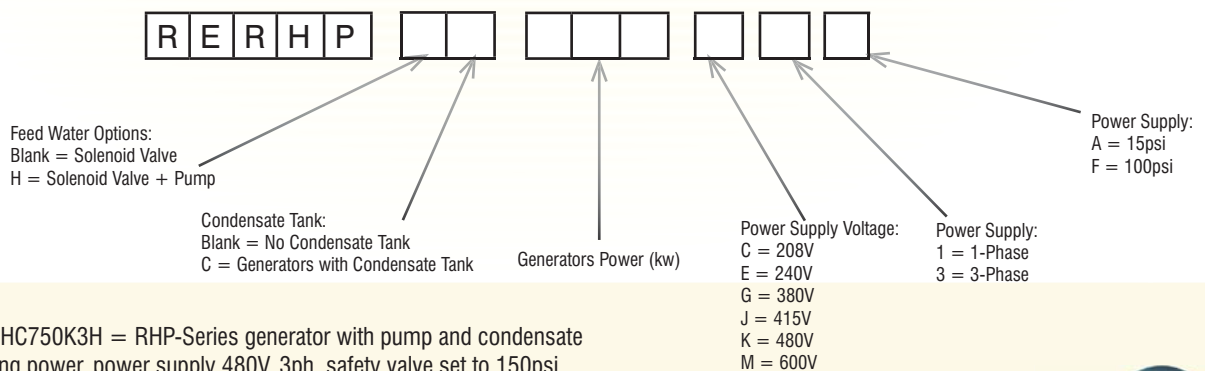

Example: RERHPHC750K3H = RHP-Series generator with pump and condensate tank, 750kw heating power, power supply 480V, 3ph, safety valve set to 150psi.

Don't forget to ask about our Descalamatics!



DEDC-6

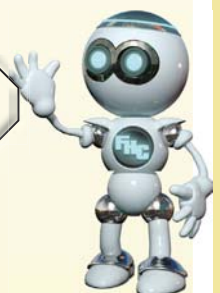

Steam Generators

Steam Generator Optional Accessories:

Pressure Controlled Boiler Blowoff System Automatic Flush & Drain (Not suitable for 24/7 operation) #REOPT1016

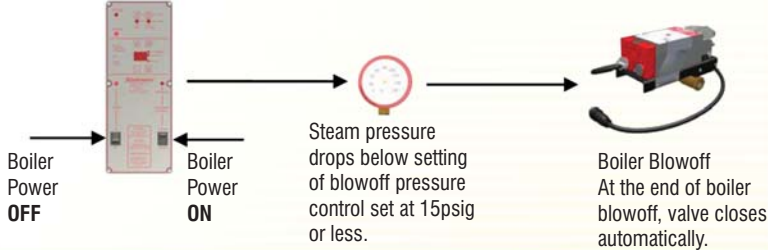

Auxillary Low Water Cut-Off with McDonnell & Miller Model MM150, #REOPTMM150



Pressure Controlled Boiler Blowoff System Automatic Flush & Drain (Not suitable for 24/7 operation) #REOPT1016

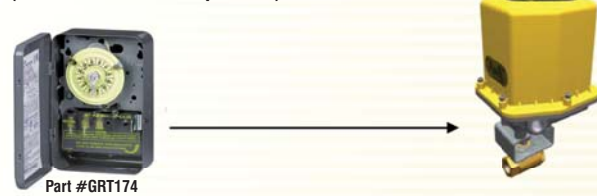

Auxillary Low Water Cut-Off with Warrick Probe Fitting in External Water Column, #REOPT1012

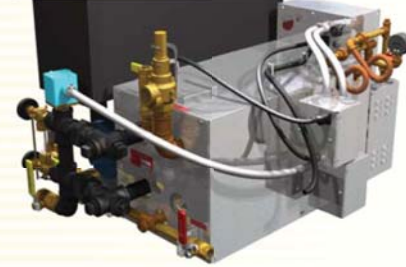

Boiler Blowoff Tank, #REBTANK-10:

*Designed in accordance with the National Board Guide for Blowoff Vessels NB-27
*Designed and manufactured in accordance with the requirements of the A.S.M.E. Boiler and Pressure Vessel Code Section VIII, Div 1. Each tank bears the National Board Stamp "U". The design pressure as per NB-27 is 50psig.

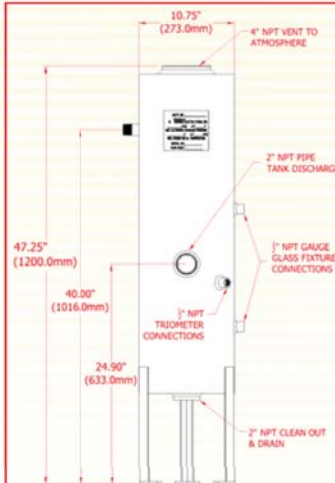

Automatic Boiler ON/OFF, # REOPT1017



Program timer to turn boiler ON/OFF automatically

Control Voltage Transformer Options: When using this option, only main power supply is required to operate boiler.

Boiler Voltage	RB and RBH Series	RBHC-Series
208V	REOPT1009 - 208RBH	REOPT1011 - 208RBHC
240V	REOPT1009 - 240RBH	REOPT1011 - 240RBHC
380V	REOPT1009 - 380RBH	REOPT1011 - 380RBHC
415V	REOPT1009 - 380RBH	REOPT1011 - 380RBHC
480V	REOPT1009 - 480RBH	REOPT1011 - 480RBHC
600V	REOPT1009 - 600RBH	REOPT1011 - 600RBHC

Boiler Wheel Set and Steam Wand for Cleaning Applications.



Steam Jet Station, # RE20845

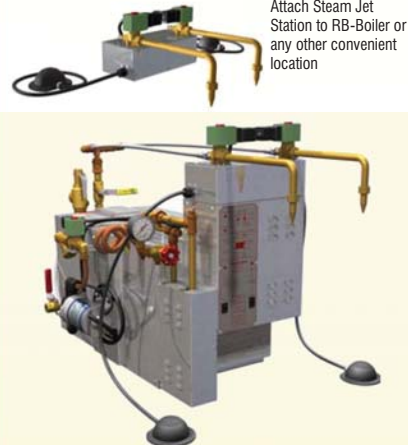

Brass and Bronze Free Boiler Trim, # REOPT1030-RB

RB-Steam boiler models fitted with carbon/stainless steel boiler trim for steam generation with very low lead concentrations. Use this option in food service and other applications where lead concentration is a concern.

Steam Filter for Culinary Steam Applications, # REOPT1032

Use this filter with FDA listed materials in food processing applications where the steam comes in direct contact with food. The 3 or 5 micron cartridges employed in this steam filter meet or exceed the 3-A guidelines for the production of Culinary Steam under Accepted Practice T609-04.

*This Page
Intentionally
Left Blank*

Washers/Disinfectors

Designed to effortlessly remove debris from instruments, our new and refurbished washers completely disinfect 99.9% of all materials removed after each and every cycle. We also include a 1 year parts and labor warranty on all of our refurbished disinfection systems!

SciCan Hydrim C61w G4 Washer

Standard Features:

- Active hot air drying
- Stainless steel exterior
- Countertop/under counter storage
- Integrated data storage w/ USB port
- 64k vivid color touch screen
- Large chamber volume
- Ethernet connection
- PIN protected w/ user ID



SciCan Hydrim L110w G4 Washer

Standard Features:

- Integrated data logger w/ USB port
- Large wash space capacity
- Included pump for liquid detergent
- Active hot air drying
- Manufactured in Canada
- Under counter or freestanding unit
- Web based doc software included
- Validates cycles for repeated washing performance
- 65k vivid color touch screen
- PIN protected with user ID



Washers/Disinfectors

SteelCo DS 50 Compact Disinfecter

Standard Features:

- Chamber dimensions: 16.34" x 18.90" x 14.76"
- External dimensions: 19.68" x 22.24" x 21.85"
- Efficient for all types of dental instruments
- Simple installation onto bench-top
- Safe solution for chemical storage
- 3 pre-set washing programs password protected
- Customizable parameters for any wash cycle
- Drop down door for convenient loading/unloading



SteelCo DS 50 DRS Compact Disinfecter

Standard Features:

- Chamber dimensions: 16.34" x 18.90" x 14.76"
- External dimensions: 22.4" x 22.63" x 21.06"
- Forced hot air drying feature
- Performance of a CSSD washer disinfecter in a more compact design
- Can store up to 40 washing programs
- Customizable parameters for any wash cycle
- Come with washing/drying injection connection
- Drop-down door for convenient loading/unloading



Washers/Disinfectors

SteelCo DS 50/2 DRS Compact Disinfector

Standard Features:

- Chamber dimensions: 16.34" x 19.68" x 14.76"
- External dimensions: 24.88" x 22.12" x 21.06"
- Forced hot air drying feature
- Performance of a CSSD washer disinfector in a more compact design
- Can store up to 40 washing programs
- Customizable parameters for any wash cycle
- Come with washing/drying injection connection
- Compact double door



SteelCo DS 50 HDRS Compact Disinfector

Standard Features:

- Chamber dimensions: 16.34" x 18.90" x 14.76"
- External dimensions: 22.05" x 22.72" x 32.48"
- Forced hot air drying feature
- Performance of a CSSD washer disinfector in a more compact design
- Can store up to 40 washing programs
- Customizable parameters for any wash cycle
- Come with washing/drying injection connection
- Drop-down door for convenient loading/unloading
- Dedicated to stand alone installation



ST50HDRS

Washers/Disinfectors

SteelCo DS 500 SC LED Medium Disinfecter

Standard Features:

- Chamber dimensions: 21.85" x 19.68" x 26.38"
- External dimensions: 23.62" x 24.80" x 33.46"
- Designed to be free-standing or under-counter unit
- Washing injection system on 2 independent levels
- Stainless steel door version only
- Stores up to 10 washing programs: 5 standard pre-programmed & 5 additional adjustable cycles
- Adjustable cycles are password protected
- Drop down door for convenient loading/unloading



SteelCo DS 500 SCL Medium Disinfecter

Standard Features:

- Chamber dimensions: 21.85" x 19.68" x 26.38"
- External dimensions: 23.62" x 24.80" x 33.46"
- Designed to be free-standing or under-counter unit
- Washing injection system and forced hot air drying on 2 independent levels
- Stainless steel version with optional glass door configuration available
- Stores up to 40 washing programs: 20 standard pre-programmed & 20 additional adjustable cycles
- Adjustable cycles are password protected
- Drop down door for convenient loading/unloading



Washers/Disinfectors

SteelCo DS 500 DRS Medium Disinfecter

Standard Features:

- Chamber dimensions: 21.85" x 19.68" x 26.38"
- External dimensions: 35.43" x 24.80" x 33.46"
- Designed to be an under-counter unit
- 2 injection connections for washing and drying
- Built-in powerful HEPA filtered forced air drying
- Upper level has telescopic bearing rails
- Stainless steel version with optional glass door configuration available
- Stores up to 40 washing programs: 20 standard pre-programmed & 20 additional adjustable cycles
- Adjustable cycles are password protected
- Drop down door for convenient loading/unloading



ST500DRS

SteelCo DS 600 Medium Disinfecter

Standard Features:

- Chamber volume: 58.12 gallons / ~ 200 liters
- Basket volume: 44.90 gallons/ ~ 170 liters
- External dimensions: (WxDxH) 25.59" x 25.98" x 66.34"
- Designed with a frontal loading, swing door
- Load capacity up to 8 DIN 1/1 mesh trays
- Available in two versions: single door or double door for pass-through application
- Filtered forced hot air drying system
- High visibility full glass door
- Stores up to 40 washing programs: 20 standard pre-programmed & 20 additional adjustable cycles
- Adjustable cycles are password protected
- Ergonomic door level height design for easy loading/unloading



ST600

Washers/Disinfectors

SteelCo DS 610 Medium Disinfecter

Standard Features:

- Chamber dimensions: 21.85" x 22.83" x 33.26"
- External dimensions: 25.59" x 27.05" x 72.44"
(specs for standard configuration single door model)
- Fully automatic frontal loading hinged door
- Available in single or double door pass-through versions
- Also available in standard or fast cycle configurations
- Complete washing and thermal disinfection treatment
- Efficient forced hot air drying system
- Load capacity up to 10 DIN 1/1 mesh trays
- Fast cycle 2S versions allows a complete cycle in 35min.
(pre-wash, main wash, rinse, thermal disinfection, drying)
- Drop down door for convenient loading/unloading



SteelCo DS 610 SL Medium Disinfecter

Standard Features:

- Chamber dimensions: 21.85" x 22.83" x 33.26"
- External dimensions: 25.59" x 27.05" x 72.44"
(specs for standard configuration single door model)
- Fully automatic frontal loading hinged door
- Available in single or double door pass-through versions
- Also available in standard or fast cycle configurations
- Complete washing and thermal disinfection treatment
- Efficient forced hot air drying system
- Load capacity up to 10 DIN 1/1 mesh trays
- Fast cycle 2S versions allows a complete cycle in 35min.
(pre-wash, main wash, rinse, thermal disinfection, drying)
- Vertical full HST glass motorized sliding doors for reduced machine encumbrance



Washers/Disinfectors



SteelCo DS 750/800 Large Disinfecter

Standard Features:

- Chamber dimensions: 23.62" x 24.61" x 34.98"
- External dimensions: 35.43" x 29.13" x 77.95"
- Vertical installed washing pump grants allows complete drain of washing circuit
- Available in standard or fast cycle configurations
- Also available in single sliding down door or double pass through washer
- 12x DIN 1/1 net basket capacity
- HEPA-filtered H14 forced air drying
- Washing cart automatic identification
- 10 standard pre-set cycle programs, 5 service programs, and 50 additional cycle programs available for customizing
- Triple water filtering system extends pump life
- Automatic motorized vertical sliding down door

SteelCo DS 900/1000 Large Disinfecter

Standard Features:

- Chamber dimensions: 28.15" x 32.09" x 37.01"
- External dimensions: 43.31" x 37.80" x 77.95"
- Largest SteelCo washer disinfecter designed to meet reprocessing needs of CSSD
- Available in single sliding down door or double pass through washer
- Also available in standard or fast cycle configurations
- Complete washing and thermal disinfection treatment
- Efficient forced hot air drying system
- Load capacity up to 18 DIN baskets (18.9" x 9.84" x 1.97")
- Fully automatic frontal loading washer
- Vertical sliding down door available in single or double door pass through version



ST900

Washers/Disinfectors

SteelCo TW 3000/2 Smart Tunnel Disinfector



ST3000/2

Standard Features:

- Chamber dimensions: 28.14" x 31.69" x 37"
- External dimensions: 45.27" x 69.88" x 77.95"
- Loading height: 33.46"
- Fully automatic, double chamber, tunnel washer
- Motorized vertical sliding doors
- 18 DIN basket capacity (18.9" x 9.84" x 1.97")
- Complete washing/thermal disinfection treatment in first of 2 chambers
- 2nd chamber dedicated to forced hot air drying phase
- 10 standard pre-set cycle programs, 50 additional cycle programs available for complete customization, and 5 service programs
- Washing, thermal disinfection, and drying cycle performed in as little as 17 minutes (includes: pre-wash, wash, rinse, thermal & drying)

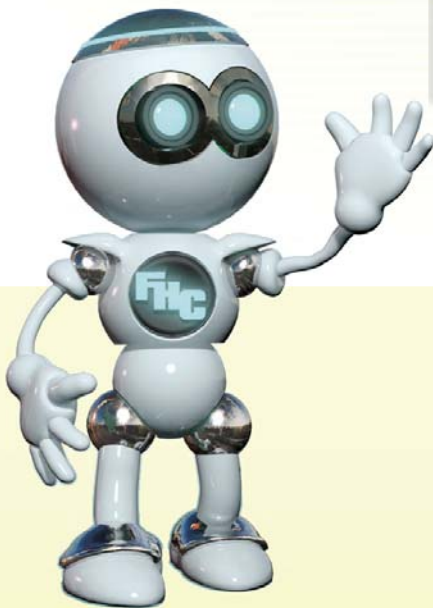

Along with a full line of Steelco and SciCan washers, we can also supply refurbished washers/disinfectors to provide quality you deserve, at an affordable price!

Washers/Disinfectors

Refurbished Reliance Synergy Washer

Standard Features:

- Choice of electric or steam heating coil
- Vertical sliding doors
- Includes Stage 3 control system
- Power doors open and close automatically
- Pump powered by dual-speed motor (7.5hp / 2hp)
- Single removable stainless-steel filter
- Rotary spray assemblies
- 16-W fluorescent lamp
- Wash chamber made of 16-gauge, #304 stainless steel
- Double-walled, insulated construction chamber exterior
- Chemical injection pumps
- Pulsed enzyme treatment
- Drying temperature range 180° or 210° F
- Airtight doors and HEPA filter
- Thermal printer



FHC-SYNERGY

Refurbished Amsco 444 Washer

Standard Features:

- Choice of electric or steam heating coil
- Vertical sliding door
- Automatic detergent injection
- Tinted tempered glass door
- Dual speed pump (7.5 hp/ 2hp)
- Processes (8) full size instrument trays in 35 - 42 min
- Drying temperature range 150°F (66°C) to 240°F (116°C)
- Double-walled insulated chamber
- Thermal printer
- Up to 1.5 hrs continuous operation



FHC-AMSCO444

*This Page
Intentionally
Left Blank*

Detergents & Cleaners



Alkaline Detergents for Automatic Washers

Name	Part #	Description
Mild Alkaline Detergent	FHC-110CK-1	Instrument detergent for automatic washers. 1 gallon plastic bottle packed 4 per case.
Mild Alkaline Detergent	FHC-110CK-5	Instrument detergent for automatic washers. 5 gallon plastic jug w/ handle.
Mild Alkaline Detergent	FHC-110CK-15	Instrument detergent for automatic washers. 15 gallon plastic drum.
Mild Alkaline Detergent	FHC-110CK-30	Instrument detergent for automatic washers. 30 gallon plastic drum.
Mild Alkaline Detergent	FHC-110CK-55	Instrument detergent for automatic washers. 55 gallon plastic drum.
Mild Alkaline Detergent - Super Concentrated	FHC-110SCLF-1	Super concentrated detergent for automatic instrument washers. 1 gallon plastic bottle packed 4 per case.
Mild Alkaline Detergent - Super Concentrated	FHC-110SCLF-2.5	Super concentrated detergent for automatic instrument washers. 2.5 gallon plastic bottles packed by case.
Mild Alkaline Detergent - Super Concentrated	FHC-110SCLF-5	Super concentrated detergent for automatic instrument washers. 5 gallon plastic jug with handle.
Mild Alkaline Detergent - Super Concentrated	FHC-110SCLF-55	Super concentrated detergent for automatic instrument washers. 55 gallon plastic drum.

Detergents & Cleaners



Neutralizer for Automatic Washers

Name	Part #	Description
Acidic Neutralizer	FHC-200-5	Neutralizes residual alkaline detergent in the rinse cycle. 5 gallon plastic jug.
Acidic Neutralizer	FHC-200-15	Neutralizes residual alkaline detergent in the rinse cycle. 15 gallon plastic drum.
Acidic Neutralizer	FHC-200-30	Neutralizes residual alkaline detergent in the rinse cycle. 30 gallon plastic drum.
Acidic Neutralizer	FHC-200-55	Neutralizes residual alkaline detergent in the rinse cycle. 55 gallon plastic drum.
Acidic Neutralizer - Super Concentrated	FHC-200SCLF-2.5	Neutralizes residual alkaline detergent in the rinse cycle. 2 X 2.5 gallon plastic jugs.
Acidic Neutralizer - Super Concentrated	FHC-200SCLF-5	Neutralizes residual alkaline detergent in the rinse cycle. 5 gallon plastic jug.
Acidic Neutralizer - Super Concentrated	FHC-200SCLF-15	Neutralizes residual alkaline detergent in the rinse cycle. 15 gallon plastic drum.
Acidic Neutralizer - Super Concentrated	FHC-200SCLF-30	Neutralizes residual alkaline detergent in the rinse cycle. 30 gallon plastic drum.

Detergents & Cleaners



Lubricant for Automatic Washers

Name	Part #	Description
Lubricant Concentrate	FHC-300-5	Lubricant to protect surgical instruments from corrosion or staining in lubrication cycle. 5 gallon plastic jug.
Lubricant Concentrate	FHC-300-15	Lubricant to protect surgical instruments from corrosion or staining in lubrication cycle. 15 gallon plastic jug.
Lubricant Super Concentrate	FHC-300SCLF-2.5	Lubricant to protect surgical instruments from corrosion or staining in lubrication cycle. 2 x 2.5 gallon plastic jugs per box.
Lubricant Super Concentrate	FHC-300SCLF-5	Lubricant to protect surgical instruments from corrosion or staining in lubrication cycle. 5 gallon plastic jug.
Lubricant Super Concentrate	FHC-300SCLF-15	Lubricant to protect surgical instruments from corrosion/ staining in lubrication cycle. 15 gallon plastic jug.
Instrument Lubricant Milk	FHC-301-1	Lubricant for manual and machine use. Lubricates and protects instruments. 1 gallon plastic bottle/4 per case.
Instrument Lubricant Milk	FHC-301-5	Lubricant for manual and machine use. Lubricates and protects instruments. 5 gallon HDPE plastic jug w/ handle.
Instrument Lubricant Milk	FHC-301-15	Lubricant for manual and machine use. Lubricates and protects instruments. 15 gallon HDPE plastic drum.
Instrument Lubricant Milk	FHC-301-30	Lubricant for manual and machine use. Lubricates and protects instruments. 30 gallon HDPE plastic drum.
Instrument Lubricant Milk	FHC-301-55	Lubricant for manual and machine use. Lubricates and protects instruments. 55 gallon HDPE plastic drum.
Instrument Spray Lubricant	FHC-302S-8	A convenient, ready to use spray lubricant to protect and extend instrument life. 8 fl. oz. HDPE spray bottles / 12 per case.
Instrument Spray Lubricant	FHC-302S-16	A convenient, ready to use spray lubricant to protect and extend instrument life. 16 fl. oz. HDPE spray bottles / 8 per case.

Detergents & Cleaners



Neutral pH Detergent for Manual & Automatic Cleaning

Name	Part #	Description
Manual Neutral pH Detergent	FHC-401-1	Neutral pH detergent for pre-soaking and manual cleaning of instruments and glassware. 1 gallon plastic bottle/ 4 per case including pump dispenser.
Manual Neutral pH Detergent	FHC-401-5	Neutral pH detergent for pre-soaking and manual cleaning of instruments and glassware. 5 gallon plastic jug w/ handle.
Neutral pH Detergent	FHC400-1	Neutral pH low foam detergent for automatic and manual cleaning. 1 gallon plastic bottle/ 4 per case.
Neutral pH Detergent	FHC400-5	Neutral pH low foam detergent for automatic and manual cleaning. 5 gallon plastic jug w/ handle.
Neutral pH Detergent	FHC400-15	Neutral pH low foam detergent for automatic and manual cleaning. 15 gallon plastic drum.
Neutral pH Detergent	FHC400-30	Neutral pH low foam detergent for automatic and manual cleaning. 30 gallon plastic drum.
Neutral pH Power Detergent	FHC400-P5	Neutral pH powder detergent for automatic and manual cleaning. 5 lbs. pails/ 6 per case.
Neutral pH Power Detergent	FHC400-P25	Neutral pH powder detergent for automatic and manual cleaning. 25 lbs. fiber drum
Neutral pH Power Detergent	FHC400-P85	Neutral pH powder detergent for automatic and manual cleaning. 30 gallon plastic drum.
Neutral pH Cleaner - Super Concentrated	FHC400-2.5	Neutral pH super concentrated low foam cleaner for manual and automatic cleaning. 2 x 2.5 gallon plastic bottles per case.
Neutral pH Cleaner - Super Concentrated	FHC400-5	Neutral pH super concentrated low foam cleaner for manual and automatic cleaning. 5 gallon plastic jug w/ handle.
Neutral pH Cleaner - Super Concentrated	FHC400-15	Neutral pH super concentrated low foam cleaner for manual and automatic cleaning. 15 gallon plastic jug w/ handle.
Neutral pH Cleaner - Super Concentrated	FHC400-30	Neutral pH super concentrated low foam cleaner for manual and automatic cleaning. 30 gallon plastic drum.

Detergents & Cleaners



Neutral pH Pre-Cleaner & Enzymatic Detergent

Name	Part #	Description
Neutral pH Pre-Cleaner	FHC-402S-22	Enzymatic foam-spray neutral pH pre-cleaner guards against post-op residual bio-burden build up. 22 fl. oz. sprayer bottle & sprayer/ 12 per case.
Neutral pH Pre-Cleaner	FHC-402S-Gal	Enzymatic foam-spray neutral pH pre-cleaner guards against post-op residual bio-burden build up.. 4 x 1 gallon bottle packed 4 per case. (Refill for 22 oz.)
Enzymatic Pre-Cleaner	FHC-402S-5	Enzymatic foam-squeeze-spraypre-cleaner guards against post-op residual bio-burden build up. 48 x 5oz bottles in a case.
Neutral pH Enzymatic Detergent	FHC-404BB-1	Surg-ENZ® Bag-in a Box reduces cleaning time by rapid, efficient removal of stubborn organic encrustation on instruments and scope washers. 2 x 1 gal per case.
Neutral pH Enzymatic Detergent - Regular Foam	FHC-404C-1	Surg-ENZ® reduces cleaning time by rapid, efficient removal of stubborn organic encrustation for manual instruments and scope cleaning. 4 x 1 gallon bottles per case
Neutral pH Enzymatic Detergent - Regular Foam	FHC-404C-5	Surg-ENZ® reduces cleaning time by rapid, efficient removal of stubborn organic encrustation for manual instruments and scope cleaning. 5 gallon plastic jug w/ handle.
Neutral pH Enzymatic Detergent - Regular Foam	FHC-404C-15	Surg-ENZ® reduces cleaning time by rapid, efficient removal of stubborn organic encrustation for manual instruments and scope cleaning. 15 Gallon plastic drum.
Neutral pH Enzymatic Detergent - Regular Foam	FHC-404C-30	Surg-ENZ® reduces cleaning time by rapid, efficient removal of stubborn organic encrustation for manual instruments and scope cleaning. 30 gallon plastic drum.
Neutral pH Enzymatic Detergent - Regular Foam	FHC-404C-55	Surg-ENZ® reduces cleaning time by rapid, efficient removal of stubborn organic encrustation for manual instruments and scope cleaning. 55 gallon plastic drum.

Detergents & Cleaners



Neutral pH Enzymatic Detergent (continued)

Name	Part #	Description
Neutral pH Enzymatic Detergent - Low Foam	FHC-404LF-1	Surg-ENZ® reduces cleaning time by rapid, efficient removal of stubborn organic encrustation on instruments and scope washers. 4 x 1 gallon bottles per case.
Neutral pH Enzymatic Detergent - Low Foam	FHC-404LF-5	Surg-ENZ® reduces cleaning time by rapid, efficient removal of stubborn organic encrustation on instruments and scope washers. 5 gallon plastic jug with handle.
Neutral pH Enzymatic Detergent - Low Foam	FHC-404LF-15	Surg-ENZ® reduces cleaning time by rapid, efficient removal of stubborn organic encrustation on instruments and scope washers. 15 gallon plastic drum.
Neutral pH Enzymatic Detergent - Low Foam	FHC-404LF-30	Surg-ENZ® reduces cleaning time by rapid, efficient removal of stubborn organic encrustation on instruments and scope washers. 30 gallon plastic drum.
Neutral pH Enzymatic Detergent - Low Foam	FHC-404LF-55	Surg-ENZ® reduces cleaning time by rapid, efficient removal of stubborn organic encrustation on instruments and scope washers. 55 gallon plastic drum.
Neutral pH Enzymatic Detergent - Super Concentrate	FHC-404SCLF-2.5	Surg-ENZ® reduces cleaning time by rapid, efficient removal of stubborn organic encrustation for manual instruments and scope cleaning. 2 x 2.5 gallon bottles per case
Neutral pH Enzymatic Detergent - Super Concentrate	FHC-404SCLF-5	Surg-ENZ® reduces cleaning time by rapid, efficient removal of stubborn organic encrustation for manual instruments and scope cleaning. 5 gallon plastic jug w/ handle.
Neutral pH Enzymatic Detergent - Super Concentrate	FHC-404SCLF-15	Surg-ENZ® reduces cleaning time by rapid, efficient removal of stubborn organic encrustation for manual instruments and scope cleaning. 15 gallon plastic drum.
Neutral pH Enzymatic Detergent - Super Concentrate	FHC-404SCLF-30	Surg-ENZ® reduces cleaning time by rapid, efficient removal of stubborn organic encrustation for manual instruments and scope cleaning. 30 gallon plastic drum.

Detergents & Cleaners



Neutral pH Enzymatic Detergent (continued)

Name	Part #	Description
Neutral pH Enzymatic Detergent - Foaming	FHC-405C-1	Scope-ZYME® multi-enzymatic cleaner is highly effective for fast, efficient removal of dried blood, proteins, fats, etc.. It is safe for all flexible/rigid scopes, metal, etc. 4 x 1 gallon bottle packed 4 per case.
Neutral pH Enzymatic Detergent - Foaming	FHC-405C-5	Scope-ZYME® multi-enzymatic cleaner is highly effective for fast, efficient removal of dried blood, proteins, fats, etc.. It is safe for all flexible/rigid scopes, metal, etc. 5 gallon plastic jug w/ handle.
Neutral pH Enzymatic Detergent - Foaming	FHC-405C-15	Scope-ZYME® multi-enzymatic cleaner is highly effective for fast, efficient removal of dried blood, proteins, fats, etc.. It is safe for all flexible/rigid scopes, metal, etc. 15 gallon plastic drum.
Neutral pH Enzymatic Detergent - Foaming	FHC-405C-30	Scope-ZYME® multi-enzymatic cleaner is highly effective for fast, efficient removal of dried blood, proteins, fats, etc.. It is safe for all flexible/rigid scopes, metal, etc. 30 gallon plastic drum.
Neutral pH Enzymatic Detergent - Foaming	FHC-405C-55	Scope-ZYME® multi-enzymatic cleaner is highly effective for fast, efficient removal of dried blood, proteins, fats, etc.. It is safe for all flexible/rigid scopes, metal, etc. 55 gallon plastic drum.

Detergents & Cleaners



Neutral pH Enzymatic Detergent (continued)

Name	Part #	Description
Neutral pH Enzymatic Detergent - Low Foam	FHC-405LF-1	Scope-ZYME® multi-enzymatic cleaner is highly effective for fast, efficient removal of dried blood, proteins, fats, etc.. It is safe for all flexible/rigid scopes, metal, etc. 4 x 1 gallon bottle packed 4 per case.
Neutral pH Enzymatic Detergent - Low Foam	FHC-405LF-5	Scope-ZYME® multi-enzymatic cleaner is highly effective for fast, efficient removal of dried blood, proteins, fats, etc.. It is safe for all flexible/rigid scopes, metal, etc. 5 gallon plastic jug w/ handle.
Neutral pH Enzymatic Detergent - Low Foam	FHC-405LF-15	Scope-ZYME® multi-enzymatic cleaner is highly effective for fast, efficient removal of dried blood, proteins, fats, etc.. It is safe for all flexible/rigid scopes, metal, etc. 15 gallon plastic drum.
Neutral pH Enzymatic Detergent - Low Foam	FHC-405LF-30	Scope-ZYME® multi-enzymatic cleaner is highly effective for fast, efficient removal of dried blood, proteins, fats, etc.. It is safe for all flexible/rigid scopes, metal, etc. 30 gallon plastic drum.
Neutral pH Enzymatic Detergent - Low Foam	FHC-405LF-55	Scope-ZYME® multi-enzymatic cleaner is highly effective for fast, efficient removal of dried blood, proteins, fats, etc.. It is safe for all flexible/rigid scopes, metal, etc. 55 gallon plastic drum.
Enzymatic Scope Cleaning Sponge Set	FHC-442	Scope cleaning sponge set with ready to use sponge soaked in enzymatic detergent for surgical instruments and all scopes.

Detergents & Cleaners



Neutral pH Cart Wash Detergent

Name	Part #	Description
Neutral pH Cart Wash Detergent - Low Foam	FHC-500-5	Cart wash detergent cleans wide range of metal surfaces and is free of metal attacking agents. 5 gallon plastic jug with handle.
Neutral pH Cart Wash Detergent - Low Foam	FHC-500-15	Cart wash detergent cleans wide range of metal surfaces and is free of metal attacking agents. 15 gallon plastic drum.
Neutral pH Cart Wash Detergent - Low Foam	FHC-500-30	Cart wash detergent cleans wide range of metal surfaces and is free of metal attacking agents. 55 gallon plastic drum.
Neutral pH Cart Wash Detergent - Low Foam	FHC-500-55	Cart wash detergent cleans wide range of metal surfaces and is free of metal attacking agents. 55 gallon plastic drum.

Cart Rinse and Drying Concentrate

Name	Part #	Description
Cart Rinse & Drying Agent	FHC-600-5	Cart rinse and drying agent for all brands of cart washers. Designed to provide efficient drying of any cart in any cart washer. 5 gallon plastic jug w/ handle.
Cart Rinse & Drying Agent	FHC-600-15	Cart rinse and drying agent for all brands of cart washers. Designed to provide efficient drying of any cart in any cart washer. 15 gallon plastic drum.
Cart Rinse & Drying Agent	FHC-600-30	Cart rinse and drying agent for all brands of cart washers. Designed to provide efficient drying of any cart in any cart washer. 30 gallon plastic drum.
Cart Rinse & Drying Agent	FHC600-55	Cart rinse and drying agent for all brands of cart washers. Designed to provide efficient drying of any cart in any cart washer. 30 gallon plastic drum.

Detergents & Cleaners



Acidic Stain & Rust Remover

Name	Part #	Description
Stain & Rust Remover	FHC-800-1	Medi-Sheen™ stainless steel reconditioner for manual and machine applications. 4 x 1 gallon bottle packed 4 per case.
Stain & Rust Remover	FHC-800-5	Medi-Sheen™ stainless steel reconditioner for manual and machine applications. 5 gallon plastic jug.
Stain & Rust Remover	FHC-800-15	Medi-Sheen™ stainless steel reconditioner for manual and machine applications. 15 gallon plastic drum.
Stain & Rust Remover	FHC-800-30	Medi-Sheen™ stainless steel reconditioner for manual and machine applications. 30 gallon plastic drum.
Stain & Rust Remover	FHC-800-55	Medi-Sheen™ stainless steel reconditioner for manual and machine applications. 55 gallon plastic drum.
Stain & Rust Remover Spray - Foaming	FHC-800-1S	Medi-Sheen™ stainless steel foaming reconditioner for manual and machine applications. 12 x 22 fl. oz. spray bottles per case (sprayers included)

Sterilizer Parts

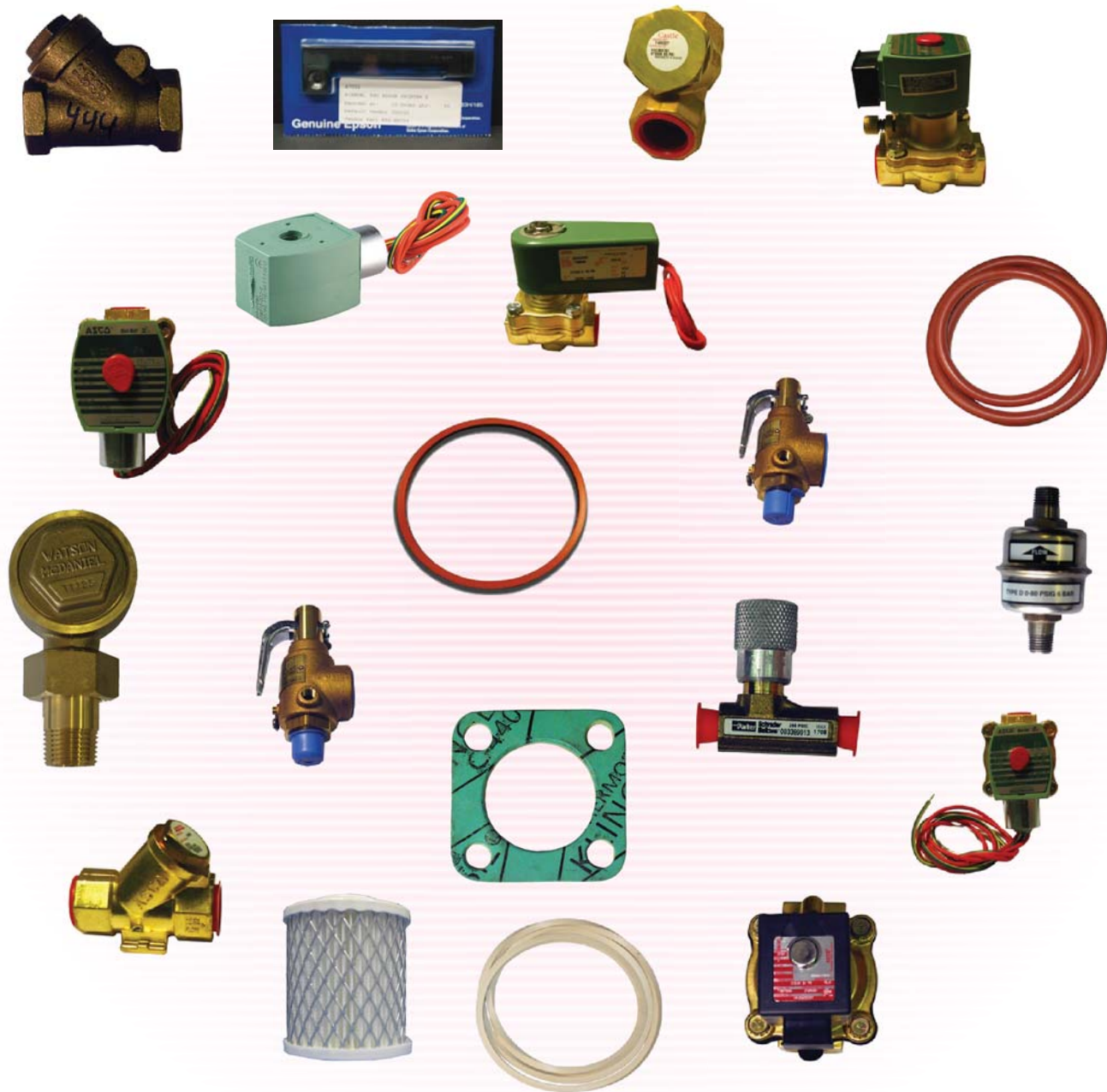

At Future Health Concepts, we carry a wide array of parts for your medical equipment needs. We stock solenoid valves, gaskets, paper ribbons, solenoid repair kits, air filters, check valves, steam traps, steam regulators, safety valves, PM packs, Bowie Dick tests, Steam Autoclave Indicator Tape, 3 & 10 Minute Flash Integrator, steam traps and more! Contact us today to see if we have the right parts for you!

Sterilizer Parts

Check Valves:

Item #	Item Description
EL0012014A	1/2 Ball Cone Check Valve \$
P-056402-068	Check Valve 1 Npt \$
P-150828-442	Check Valve 1/2 Swing
P-150822-354	Check Valve 1/2 Swing Brz 125# Ips Viton \$
P-150829-501	Check Valve 1/4 \$
P-083521-001	Check Valve 1/4 Npt
P-010278-091	Check Valve 1/4 Swing Brz 125# Ips Viton \$
P-056402-067	Check Valve 3/4 Npt
P-150828-444	Check Valve 3/4 Swing Brz 125# Ips Viton \$
P-083870-001	Check Valve 3/4 Vertical Brz 125# Teflon \$
P-056402-065	Check Valve 3/8 Npt
P-005424-091	Check Valve 3/8 Swing Brz 125# Ips Viton
AUV01213	Check Valveasco 3/4 Fpt
GE513699	Check Valve Getinge 1 Fpt \$
GE513362	Check Valve Getinge 1/2 Fpt \$
GE513363	Check Valve Getinge 3/4 Fpt \$
GE513361	Check Valve Getinge 3/8 Fpt \$
RE02370	Check Valve Reimers 1/2
RE02692	Check Valve Reimers 1/2 Ball Cone Spring
RE02462	Check Valve Reimers 1/2 Swing
P-150829-647	Check Valve Steris 1/2 Ck 6 Viton \$
P-056402-066	Check Valve Steris 1/2 Npt \$
P-764321-287	Check Valve Steris 1/4 Cone \$
P-150829-648	Check Valve Swing Check 3/4



Sterilizer Parts

Repair Kits:

Item #	Item Description
C038-004-01	3/4 Vac Breaker Repair Kit
FHC-764072-001	Fhc Kit Repair (S-4,S-7) 12F22C2-Z01R(FHC-093911-328)
FHC-764324-895	FHC Kit Repair Valve (S-1) (FHC-093911-329)
FHC-764317-688	FHC Kit Repair Valve (S-2)(FHC-093911-331)(16F24C2-201R)
FHC-764317-687	Fhc Kit Repair Valve (S-2,S-9) (FHC-093910-650)
FHC-764070-001	FHC Kit Repair Valve (S-3) (FHC-093910-477)
FHC-764071-001	FHC Kit Repair Valve 1 (S-16) (FHC-093911-327)
FHC-764078-001	FHC Kit Repair Valve 3/4 (S-1) (FHC-084444-002)
FHC-764073-001	FHC Kit Repair Valve 3/8 (S-4) (FHC-083263-002)
RE04245	Guage Set Reimers Valve Repair Kit
RE03314	Kit Reimers Repair For Re02585 Water In Solenoid .375
GE61301604084	Kit Repair (517346)
P-754361-003	Kit Repair Angle Valve 3/4 Npt
GE513369-1/2	Kit Repair Check 1/2 Fpt
AU216287	Kit Repair Check 3/4 Fpt
GE513369-3/4	Kit Repair Check 3/4 Fpt
GE513369-3/8	Kit Repair Check 3/8 Fpt
GE68145	Kit Repair Service Package (517347)
GE56161	Kit Repair Service Package (517349)
GE61301600442	Kit Repair Service Package (541582)
GE61301608963	Kit Repair Service Package (61301608583)
GE54190	Kit Repair Service Package 51734553177/61457
GE54185	Kit Repair Spare Parts Package (517342)
GE54186	Kit Repair Spare Parts Package (517342)
GE54187	Kit Repair Spare Parts Package 517343
P-754359-003	Kit Repair Steam Regulator 3/4
P-754359-001	Kit Repair Steam Regulator 3/8
P-764324-147	Kit Repair Steris Valve 1/2

Sterilizer Parts

Repair Kits: (Cont.)

Item #	Item Description
P-764320-920	Kit Repair Steris Valve Eagle 10
P-764324-090	Kit Repair Valve 1/8
GE27557	Kit Steam Trap 3/4 Npt Rebuild
P-764080-001	Kit Steam Trap Repair 1/2 3/4
P-117951-000	Kit Steris Solenoid Steam 1
K302020	Kit Valve Repair
K302306	Kit Valve Repair
K304392	Kit Valve Repair
K312702	Kit Valve Repair
P-764075-001	Kit Valve Repair
P-764188-001	Kit Valve Repair
P-764319-952	Kit Valve Repair
P-117950-211	Kit Valve Repair
P-754742-091	Kit Valve Repair
P-764137-001	Kit Valve Repair
P-764265-001	Kit Valve Repair
P-764321-495	Kit Valve Repair
P-764322-007	Kit Valve Repair
P-764324-355	Kit Valve Repair
P-764330-438	Kit Valve Repair (3017)
P-764328-522	Kit Valve Repair (51808)
P-764328-225	Kit Valve Repair (61301600442)
P-764324-895	Kit Valve Repair (S-1)
P-764317-687	Kit Valve Repair (S-2 S-9)
P-764070-001	Kit Valve Repair (S-3)
P-764317-688	Kit Valve Repair 1 (S-2)
P-764071-001	Kit Valve Repair 1 (S-3)
K302283-E	Kit Valve Repair 1 Jht8210B54E

Sterilizer Parts

Repair Kits: (Cont.)

Item #	Item Description
K302273	Kit Valve Repair 1/2 (8210)
K304030	Kit Valve Repair 1/2 J8222A76
K302014	Kit Valve Repair 1/2 J8262C2
P-764323-595	Kit Valve Repair 1/4 (Steam Generator) Model Chs
K302015	Kit Valve Repair 1/8 8262C043
P-764189-001	Kit Valve Repair 1-1/4
P-764324-356	Kit Valve Repair 3/4
P-764324-417	Kit Valve Repair 3/4
P-764078-001	Kit Valve Repair 3/4 (S-1)
P-764072-001	Kit Valve Repair 3/4 (S-4S-7)
K302277	Kit Valve Repair 3/4 J8210D9
K304032	Kit Valve Repair 3/4 J8222A49
K304669	Kit Valve Repair 3/4 J8222E3
P-764187-001	Kit Valve Repair 3/8
P-764073-001	Kit Valve Repair 3/8 S-4
GE68164	KIT VALVE REPAIR 517338,32664
GE61301600443	Kit Valve Repair 541581, 61301601701
GE61301609163	Kit Valve Repair 61301601697
GE61301608965	Kit Valve Repair 61301608458 (700 Series)
K310304	Kit Valve Repair 8263 Ac 1/4 3/8
P-764326-482	Kit Valve Repair Exhaust Manifold
K300092	Kit Valve Repair For Hv222309-1
K312487	Kit Valve Repair For Hv2585491 (EI0013092A) Water In Steam
K310635	Kit Valve Repair J8220A1 J8220A3 3/81/2
K310716	Kit Valve Repair J8220A5
P-764316-147	Kit Valve Repair Solenoid
P-764324-556	Kit Valve Repair Solenoid
P-764326-478	Kit Valve Repair Stm Exhaust

Sterilizer Parts

Repair Kits: (Cont.)

Item #	Item Description
P-764326-479	Kit Valve Repair Stm Exhaust
P-764326-621	Kit Valve Repair Water Manifold
GE513700	Repair Kit Check Valve 1 Fpt
K310416	Valve Repair Kit
K323468	Valve Repair Kit 1/2 8220 Ac
K312712	Valve Repair Kit 1/2 8220G21
K304031	Valve Repair Kit 1/2 J8222B93J8222B94J8222B95
K302037	Valve Repair Kit 1/4 3/8 8263
K304354-E	Valve Repair Kit 1/8 1/4 Or 3/8 8262
K220938	Valve Repair Kit 10/Bx
K220939	Valve Repair Kit 10/Bx
K302791	Valve Repair Kit 3/4 8030 Ac
K302272	Valve Repair Kit 3/8 1/2 3/4 8210
K302841	Valve Repair Kit 3/8 8267B009
K302347	Valve Repair Kit 8210 Ac
K302327-E	Valve Repair Kit For 8210 Ac
K302334	Valve Repair Kit For 8210 Ac
K302335	Valve Repair Kit For 8210 Ac P
K304057	Valve Repair Kit For 8222 Ac
K258249-E	Valve Repair Kit For F210



M6

Sterilizer Parts

Door Gaskets:

Item #	Item Description
P-074367-091	Door Gasket Amsco 16 x 16
P-078767-091	Door Gasket Amsco 20 x 20
P-097487-091	Door Gasket Amsco 24 x 36
P-075006-091	Door Gasket Amsco 24 x 36 w/ 32 Socket HD
P-146653-007	Door Gasket Amsco 900 901
P-426637-261	Door Gasket Amsco Eagle 10 & 10 Plus
GE513966	Door Gasket Castle 16 x 16 U-Shape
GE513967	Door Gasket Castle 20 x 20 U-Shape
GE536651	Door Gasket Castle 3600 24 x 36 Red
GE58397	Door Gasket Castle VD 16 x 16
GE61301605017	Door Gasket Castle VD 20 x 20
GE58398	Door Gasket Castle VD 20 x 20
FHCW0020	Door Gasket FHC Bottom FHCDWC24 S/S Warming Cabinet
FHCW0078	Door Gasket FHC Bottom FHCDWC60 S/S Warming Cabinet
FHCW0019	Door Gasket FHC Top FHCDWC24 S/S Warming Cabinet
FHCW0205	Door Gasket FHC W/C SWC24-G DWC24-G Upper (Glass Door)
FHCW0212	Door Gasket FHC Warming Cabinet FHCSWC1824 (Glass Door)
FHCW0082	Door Gasket FHC Warming Cabinet FHCSWC1824 (S/S Door)
FHCW0080	Door Gasket FHC Warming Cabinet FHCSWC36 (S/S Door)
FHCW0109	Door Gasket FHC Warming Cabinet FHCSWC36-G (Glass Door)



Sterilizer Parts

Door Gaskets: (cont.)

Item #	Item Description
FHCW0081	Door Gasket FHC Warming Cabinet FHCSWC72 (S/S Door)
FHCW0192	Door Gasket FHC Warming Cabinet FHCSWC72-G (Glass Door)
FHCW0206	Door Gasket FHC Warming Lower Cabinet FHCDWC24-G (Glass Door)
P-146660-159	Door Gasket G-116 V-116
GE61301605016	Door Gasket Getinge 20 x 20 133HC Blue Solid
GE61301609907	Door Gasket Getinge 833
GE61301607691	Door Gasket Getinge VD 16 x 16 400 Series
GE61301607692	Door Gasket Getinge VD 20 x 20 500 Series
GE61301609906	Door Gasket Getinge VD 26 x 36 700 Series
REPCG019	Door Gasket Pelton Crane (Magnaclave)
REPCG014	Door Gasket Pelton Crane (OCM)
REPCG015	Door Gasket Pelton Crane (OCR)
REPCG065	Door Gasket Pelton Crane Validator
RCG019	Door Gasket Ritter 7 & M7
P-146660-160	Door Gasket Steris G-120V - 120
TU02610020	Door Gasket Tuttnauer 1730MK
TU02610118	Door Gasket Tuttnauer 2340E/EK, 2340M/MK
TU02610023	Door Gasket Tuttnauer 2540E, 2540EK, 2540M, 2540MK, EZ10K
P-101007-551	Door Gasket Vernitron 20 x 20
P-129373-376	Steris Door Gasket 26 x 37 1/2 (V-136, 48, 60)

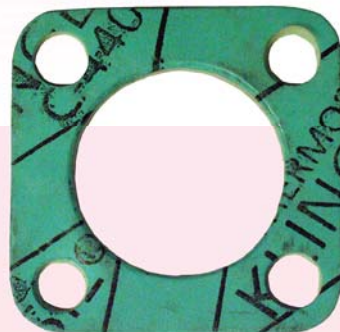
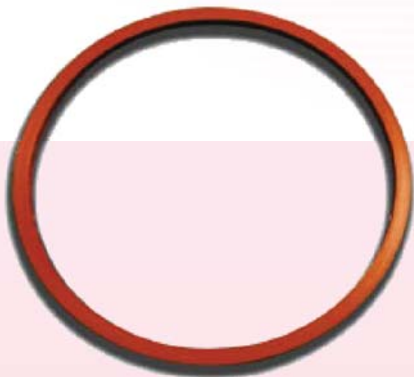

Sterilizer Parts

Solenoid Valves:

Item #	Item Description
J8210D2	1/2 120/60 Nc Solenoid Valve
J8222A76	1/2 120/60 Nc Solenoid Valve
FHC-093911-331	FHC Solenoid Valve 1 (16F24C2-Z01Aafph0569)
FHC-093911-327	FHC Solenoid Valve 1 (16Fj5C2-Z01Adfph0569) M-S3S16 S-S16
FHC-093911-328	FHC Solenoid Valve 3/4 (12F22C2-Z01Aafph0569) M-S4S7 S-7
FHC-093911-329	FHC Solenoid Valve 3/4 (12F2302148Acfph0569W) M-S1 S-S1
FHC-093910-477	FHC Solenoid Valve 3/4 (12Fs3C2-Z02Acfph0569) M-S5 S-S3
FHC-093910-650	FHC Solenoid Valve 3/8 S-S2S9 (06Fs5C2-Z03Acfph0569)
FHC-083228-002	FHC Valve Solenoid 3/4 (S-3S-5) (12Fs3C2-Z02Aaf4C0569)
FHC-083261-002	FHC Valve Solenoid 3/4 (S-4S-7) (12F22C2-Z01Aaf4C0569)
FHC-083263-002	FHC Valve Solenoid 3/8 (S-4) (06F23C2-Z01Acf4C0569)
EL0013998	Solenoid Valve Electro Steam 1/2 Water Inlet
EL0013998B	Solenoid Valve Electro Steam 1/2 Water Inlet 220V
P-764323-548	Solenoid Valve Emerson 204Cd 1/4B5/32P \$
RE02585	Solenoid Valve Reimers .375 120V Water \$
RE02301	Solenoid Valve Reimers .50 120V Water \$
P-093911-327	Solenoid Valve Steris 1 120/60
P-093911-331	Solenoid Valve Steris 1 S-2 S9
P-338520-126	Solenoid Valve Steris 1/2 Npt (444) \$
P-093910-477	Solenoid Valve Steris 3/4 120/60
P-093911-328	Solenoid Valve Steris 3/4 120/60
P-093911-329	Solenoid Valve Steris 3/4 120/60
P-093910-650	Solenoid Valve Steris 3/8 120/60
GE61301604961	Valve Getinge Solenoid
GE61301601695	Valve Getinge Solenoid 24/60 100 Series
GE61301601698	Valve Getinge Solenoid 24/60 100 Series



M9

Sterilizer Parts

Solenoid Valves: (cont.)

Item #	Item Description
GE61301601696	Valve Getinge Solenoid 24/60 100 Series \$
GE61301608423	Valve Getinge Solenoid 24/60 400 Series
GE61301604082	Valve Getinge Solenoid 2-Way Nc 1 24Vac E
GE61301601697	Valve Getinge Solenoid 3/8 24/60 Steam To Chamber \$
GE517357	Valve Getinge Solenoid Door Safety \$
GE517356	Valve Getinge Solenoid Mld 3 Flow Nc .750-14
GE517355	Valve Getinge Solenoid Mld 3Way Nc .250-18
GE541581	Valve Getinge Solenoid S3 Air-In \$
GE517300	Valve Replacement Solenoid Coil 517339
P-150822-311	Valve Solenoid 1 (S-2) 120/60 \$
P-083229-002	Valve Solenoid 1"
P-117950-179	Valve Solenoid 1/2 \$
J8220A3	Valve Solenoid 1/2 120/60 Nc
AU8210G2	Valve Solenoid 1/2 Water 120/60110/50
P-764328-224	Valve Solenoid 1/4
HV222309-1	Valve Solenoid 1/4 3-Way 120/60
GE517338	Valve Solenoid 1/4 Fpt Nc Tpl# 21319 120/60 \$
P-093910-479	Valve Solenoid 1/4 Npt
P-093910-478	Valve Solenoid 1/4 Npt 120/60
J8262C2	Valve Solenoid 1/8 120/60 Nc
GE61301601701	Valve Solenoid 2-Way 3/4 24/60 22/50 Nc \$
GE517339	Valve Solenoid 2-Way 3/8 Fpt Nc 120/60V \$
GE517347	Valve Solenoid 2-Way 3/8 Nc 120/60V \$
P-083228-002	Valve Solenoid 3/4 (S-3S-5)
P-083261-002	Valve Solenoid 3/4 (S-4S-7)
P-764319-004	Valve Solenoid 3/4 120/60 \$



M10

Sterilizer Parts

Solenoid Valves: (cont.)

Item #	Item Description
J8220A5	Valve Solenoid 3/4 120/60 Nc Solenoid Valve
J8222A49	Valve Solenoid 3/4 120/60 Steam
GE517349	Valve Solenoid 3/4 Fpt 120/60 Nc \$
P-084444-002	Valve Solenoid 3/4 Npt (S-1) \$
P-150822-309	Valve Solenoid 3/8
P-083263-002	Valve Solenoid 3/8 (S-4) \$
J8220A1	Valve Solenoid 3/8 120/60 Nc
AUSC8222G2	Valve Solenoid 3/8 24/60V
AU8210G1	Valve Solenoid 3/8 Water 120V/60Hz
GE61301604083	Valve Solenoid Chamber Drain 517346, 61301604083 120/60V
GE517342	Valve Solenoid Jacket 3/4 120/60V \$
GE541582	Valve Solenoid S/S 1/4 Fpt120/60 Nc 3 Way Tpl#18877 \$
AU8262C43	Valve Solenoid S/S 1/8 120/60 Nc
P-117956-362	Valve Solenoid S/S Water 1/2 Npt 120/60 \$
GEV502011800	Valve Solenoid Steam
GEV503001700	Valve Solenoid Steam 230/50-60 \$
GEV503114100	Valve Solenoid Steam 230/50-60 \$
GE517341	Valve Solenoid Steam To Chamber 1 120/60V (6900)
P-084430-002	Valve Solenoid Steris 3/8 120/60 Npt \$
PAVA13-W5	Valve Solenoid Wheel Operated
GE61301609315	Valve Solenoid Wtrhmr 2-Way 3/4 Npt
P-117956-360	Valve Solenoid-1/2 Steam Npt 120/60 \$
P-117956-359	Valve Solenoid-1/2 Water Npt 120/60 \$
GE61301609450	Valve solenoid 2-Way Nc.375 24Vac Air In (433)
EL0013092A	Water Inlet Solenoid 3/8



M 1 1

Sterilizer Parts

Safety Valves:

Item #	Item Description
P-075421-091	Safety Valve 1/2 X 1 100 PSI
P-764323-459	Safety Valve 1/2 X 1 100 PSI
C029-202-21	Safety Valve 1/2 X 1 100 PSI (V)
C029-202-62	Safety Valve 1/2 X 1 33 PSI (UV)
C029-202-61	Safety Valve 1/2 X 1 36 PSI (UV)
GE61301604180	Safety Valve 1/2 X 1 40 PSI (UV) Steam
C019-KDCL-50	Safety Valve 1/2 X 3/4 50 PSI (UV)
P-093918-511	Safety Valve 1/2 X 3/4 50 PSI (UV)
P-764316-742	Safety Valve 100 PSI
P-764323-460	Safety Valve 100 PSI (Steam) 1/2 X 3/4
P-084342-001	Safety Valve 3/4 36 PSI (UV)
GE56913	Safety Valve 3/4 X 1 40 PSI (UV) Steam
C029-303-21	Safety Valve 3/4 X 1-1/4 100 PSI (V)
P-150828-478	Safety Valve 40 PSI (Steam) 1 X 1-1/4
P-150828-473	Safety Valve 40 PSI (Steam) 1/2 X 3/4
P-150828-476	Safety Valve 40 PSI (Steam) 3/4 X 1
EL0012003	Safety Valve Electro-Steam 1/2 100 PSI
GE56916	Safety Valve Getinge 1 X 1-1/4 40 PSI (UV)
GE49949	Safety Valve Getinge 1/2 X 1 100 PSI
GE62257	Safety Valve Getinge 1/2 X 1 40 PSI (UV) Steam
GE61301608100	Safety Valve Getinge 45 PSI (Steam) 1/2 X 3/4
GE61301601576	Safety Valve Getinge 45 PSI (Steam) 3/4 X 1
RE02637	Safety Valve Reimers 1/2" X 1" 100# Swp
RE02010	Safety Valve Reimers 3/4 15# Swp H.Whl
RE03571	Safety Valve Reimers S/S .5 100# Swp 3/4
P-056402-028	Safety Valve Steris 1" Npt Ped 45 PSI UV (Steam)
P-093921-266	Safety Valve Steris 45 PSI UV 1 X 1-1/4 (Steam)
SU99137	Safety Valve Sussman Es-100-180 1 X 1-1/4 100 PSI



M12

Sterilizer Parts

Steam Traps:

Item #	Item Description
P-129222-001	Steam Trap 1/2 NPT
GE23614	Steam Trap 3/4 NPT
GE61301602492	Steam Trap Geringe .50 NPT



Air Filters:

Item #	Item Description
47225	Air Filter
GE61301600303	Air Filter, Geringe (100 Series)
P-093909-592	Filter, Steris Air Assembly



Solenoid Coils:

Item #:	Item Description
P-764324-600	Coil, 1 Solenoid (P-093911-327)
P-764323-941	Coil, 3/4 Solenoid S1, S2, S3, S9, S35, S37, S40
238210-032-D	Coil, Solenoid 120/60 110/50 (AU8210G1)
238212-032	Coil, Solenoid 120/60 w/ Din Terminal Connector (SC8210G2)
P-764326-632	Coil, Solenoid S1
P-764323-940	Coil, Solenoid S4, S7
P-764323-942	Coil, Solenoid

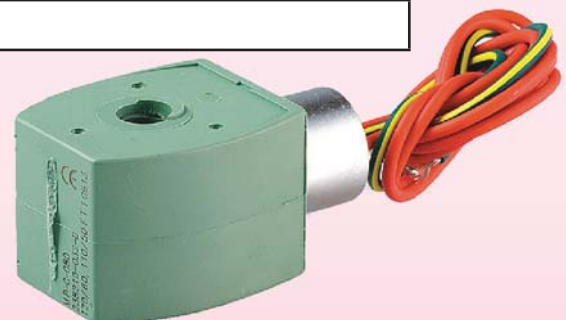

Sterilizer Parts

PM Packs:

Item #	Item Description
P-764324-193	P/M Kit E2 And 3 Sm Vac Sol Valve
P-764324-747	P/M Kit Stage 3 Gravity 16/20 Sterilizer
P-764324-749	P/M Kit Stage 3 Pre-Vac 16/20 Sterilizer
P-754360-002	PM Pack 16 Door
P-754360-003	PM Pack 20 Door
P-764326-486	PM Pack Century D/D Manifold
P-764332-098	PM Pack Century Medium
P-764324-196	PM Pack Door 24X36 2000/3000 Single Door
P-764324-197	PM Pack E2 & 3 Med Vac Prv Valve
P-764324-188	PM Pack E2 & 3 Sm Vac Prv Valve
P-764324-198	PM Pack E2 & E3 Medium Gravity Solenoid Valve
P-764332-060	PM Pack Eagle 2000/3000 S2 Med Vac
P-764332-061	PM Pack Eagle 2000/3000 S3 16/20 Gravity
P-764324-202	PM Pack Eagle 2000/3000 S3 16/20 Gravity Sol Vlv
P-764332-058	PM Pack Eagle 3000 S3 1620 Small Vac
P-764332-096	PM Pack Eagle 3000 S3 Med Vac Solenoid Valves Kits
P-764332-067	PM Pack Eagle 3000 S3 Small Vac 1620 Solenoid Valves Kits
P-764332-056	PM Pack Eagle 3K Stage 3 Med Vac
P-764326-480	PM Pack Exhaust Manifold (Less Seats)
FHC-764330-259	PM Pack FHC Major Insp #2 S3 1620 Vac 1620 FHC Valves
P-764330-245	PM Pack Major #1 Intergal Generatorchromalox Chs
P-764330-818	PM Pack Major #1 Synergy
P-764330-819	PM Pack Major #1 Synergy (Electric Units)
P-764330-262	PM Pack Major #2 2000/3000 Stage 2 Vacmatic 24X36
P-764330-247	PM Pack Major #2 Intergal Generator Chromalox Chs
P-764330-264	PM Pack Major #2 Stage 3/Renaissance 24 X 36 Vac
P-764330-306	PM Pack Major Insp #1 444 Before S/N-3624502-XXX W/D

Sterilizer Parts

PM Packs: (cont.)

Item #	Item Description
P-764330-816	PM Pack Major Insp #1 444 W/D After S/N-3624502-Xxx
P-764330-305	PM Pack Major Insp #1 444 W/D B4 S/N-3624502-XXX (Steam Heated Unit)
P-764330-257	PM Pack Major Insp #2 2000 S2 1620 Vac
P-764332-062	PM Pack Major Insp #2 2K3K Stage 2 1620 Vac
P-764330-302	PM Pack Major Insp #2 410 W/D
P-764330-817	PM Pack Major Insp #2 444 W/D After S/N-3624502-Xxx
P-764330-259	PM Pack Major Insp #2 S3 1620 Vac 1620 Ren Vac
P-764332-065	PM Pack Misc Century Small Grav & Vac
P-764324-201	PM Pack Package E2 & 3 Sm Gravity Prv & Vlv
P-764326-524	PM Pack Reliance 444 Washer
P-764326-844	PM Pack Solenoid Valves Flj
P-764324-752	PM Pack Stage 3 G.P. Check Valves
P-764324-756	PM Pack Stage 3 Gp lws Filter
P-764326-475	PM Pack Steam Manifold (Less Seats)
P-764334-176	PM Pack Steris Pk 2 26X37.5 Prevacuum
P-764334-175	PM Pack Steris Pk1 26X37.5 Prevacuum
P-764325-763	PM Pack Trap/Chk Valve 3000-3
P-764326-519	PM Pack Valve Repair (3017)
P-764326-619	PM Pack Valve Repair Water Manifold (Less Seats)



Sterilizer Ink/Ribbons:

Item #:	Item Description
P-150828-440	Ribbon Amsco Century 2/PK (Epson)
47024	Ribbon FHC Epson Printer
GE61301600006	Ribbon Getinge Printer
GE61301687314	Ribbon Getinge/Castle Epson Printer
P-129356-118	Ribbon Steris Ink 2/BX (Olivetti)



Sterilizer Parts

Repair Services:

**Celebrating Over 40 Years
of Loyal Service.**



Don't forget Future Health Concepts also has specially trained, and qualified service technicians to perform maintenance on the majority of your medical equipment at an affordable price!

Transport Stretchers



FHC7100

FHC 7100 MobileCare Transport Stretcher

Standard Features:

- 8" Tente total/directional locking casters
- Brake steer pedals all 4 corners
- Single cylinder Fowler assist
- Dual pedestal lift mechanism
- Trendelenburg/reverse Trendelenburg
- Lift/Trendelenburg pedals on both sides
- Fold forward side rails w/ built in push handles
- 4" standard mattress
- 2 hook removable telescopic I.V. pole
- I.V. pole sockets at all corners
- O2 storage underneath

Optional Features:

- Fold down push handles
- Manual knee gatch
- Manual Fowler
- 29" or 31" wide patient surface

Specifications:

Overall dimensions: 83" long x 31" wide
Patient surface: 75" long x 26" wide
Height adjustment range: Min 23"/Max 35"
Trend/reverse Trend: +/- 18°
Fowler position: 90°
I.V. attachment sockets: 4
Weight capacity: 550 lbs

Stretcher Pad Specs:

Overall dimensions: 83" long x 31" wide
Patient surface 75" long x 26" wide

FHC7100-29 Wide:

Overall dimensions: 83" long x 34" wide
Patient surface: 75" long x 29" wide

FHC7100-31 Extra Wide:

Overall dimensions: 83" long x 36" wide
Patient surface: 75" long x 31" wide

Transport Stretchers



FHC7200

FHC 7200 MobileCare Transport Stretcher

Standard Features:

- 5th Wheel
- 8" Tente total/directional locking casters
- Brake steer pedals all 4 corners & both ends, 6 total
- Dual cylinder Fowler assist
- Dual pedestal lift mechanism
- Trendelenburg/reverse Trendelenburg
- Lift/Trendelenburg pedals on both sides
- Fold forward side rails w/ built in push handles
- 4" standard mattress
- 2 hook removable slow descent telescopic I.V. pole
- I.V. pole sockets at all corners
- O2 storage underneath stretcher top

Optional Features:

- Fold down push handles
- Manual knee gatch
- Manual Fowler

Specifications:

Overall dimensions: 83" long x 31" wide
Patient surface: 75" long x 26" wide
Height adjustment range: Min 23"/Max 35"
Trend/reverse Trend: +/- 18°
Fowler position: 90°
I.V. attachment sockets: 4
Weight capacity: 750 lbs

Stretcher Pad Specs:

Overall dimensions: 83" long x 31" wide
Patient surface 75" long x 27" wide

FHC7200-31 Extra Wide:

Overall dimensions: 83" long x 35" wide
Patient surface: 75" long x 31" wide

Transport Stretchers

NEW

FHC7200
5th WHEEL, 750 lb CAPACITY
TRANSPORT STRETCHER



Come see what our stretchers have to offer your facility. Future Health Concept's Transport Stretchers provide the best blend of features, value, and customer support in the industry.

CALL OR EMAIL US TODAY!

www.fhcusa.com

Phone: (888)282-8644.

sales@fhcusa.com

RETRACTABLE CENTER FIFTH WHEEL PROVIDES STRAIGHT LINE MOBILITY ALONG WITH EFFORTLESS PIVOTING AND CORNERING

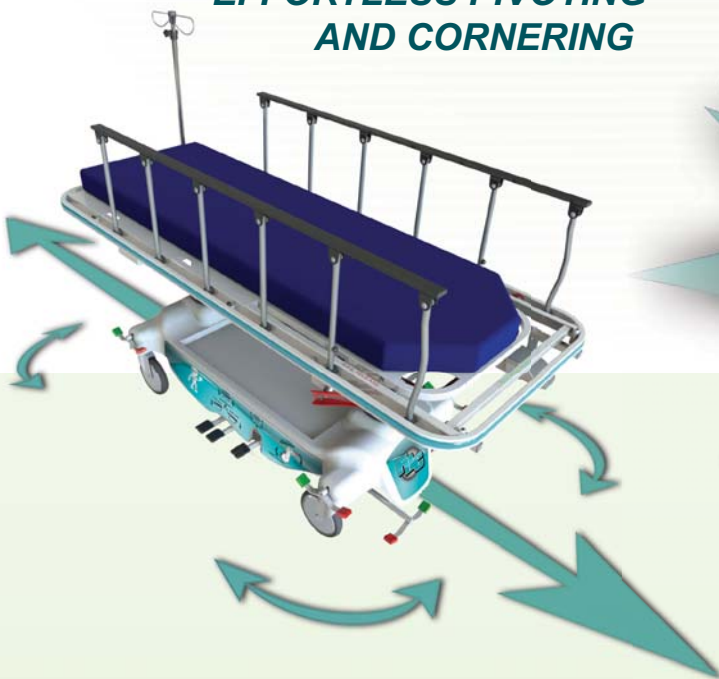

OMNI-DIRECTIONAL STEERING
MAKES FOR EASY STORAGE
IN TIGHT SPACES

N3

Transport Stretchers



**TREND/REVERSE TREND $\pm 18^\circ$
SIX BRAKE/STEER PEDAL LOCATIONS**



**DUAL FOWLER ASSISTED LIFT BACK
REST WITH 90° OF ADJUSTABILITY**

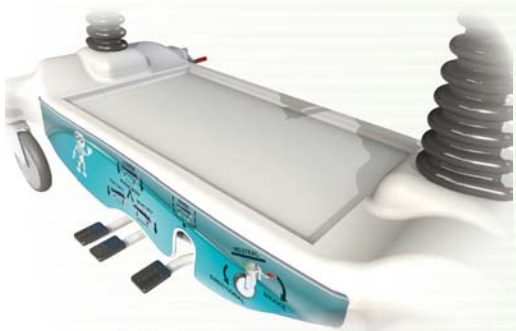

**LARGE STORAGE AREA FOR
PATIENT BELONGINGS**

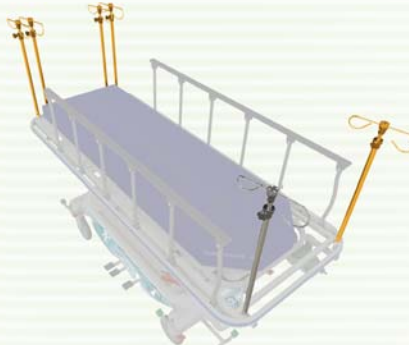

**SIX I.V. POLE
CONFIGURATIONS**



**ERGONOMICALLY
LOCATED O₂
TANK HOLDER**

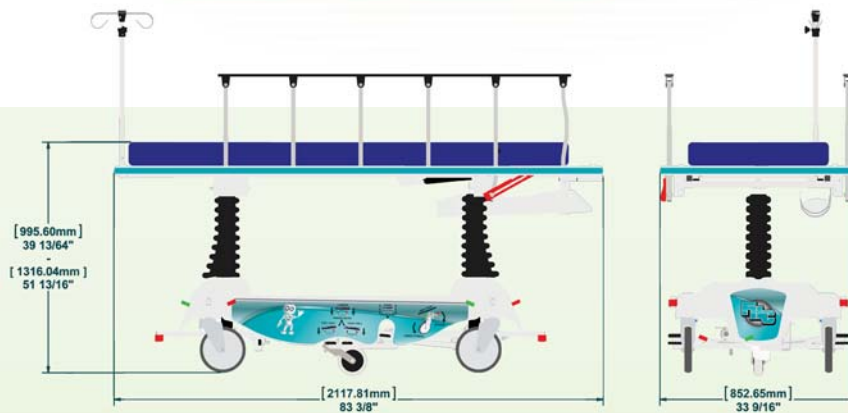
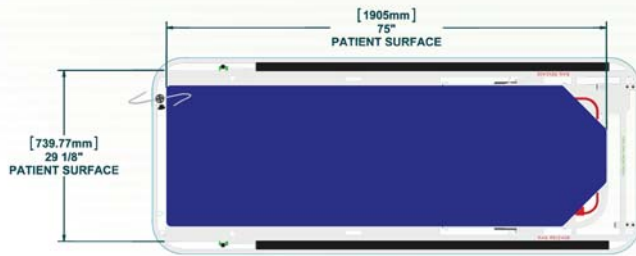

information regarding this product is subject to change without prior notice

Transport Stretchers



FHC7100-EYE1

FHC 7100-Eye Mobilecare Transport Stretcher

Standard Features:

- Quick adjustment dual articulating head attachment
- Low profile for surgeon leg room
- 8" Tente total/directional locking casters
- Brake steer pedals all 4 corners
- Manual Fowler assist
- Manual knee gatch
- Dual pedestal lift mechanism
- Trendelenburg/reverse Trendelenburg
- Lift/Trendelenburg pedals on both sides
- Fold forward side rails w/ built-in push handles
- 4" standard mattress
- 2 hook removable telescopic I.V. pole
- I.V. pole sockets at all corners
- O2 storage underneath

(optional wrist rest available)

Specifications:

Overall dimensions: 94" long x 31" wide
Patient surface: 85" long x 25" wide
Height adjustment range: Min 23"/Max 35"
Trend/reverse Trend: +/- 18°
Fowler position: 90°
I.V. attachment sockets: 4
Weight capacity: 550 lbs

FHC7100-29-EYE1 Wide:

Overall dimensions: 83" long x 35" wide
Patient surface: 85" long x 29" wide

FHC7100-31-EYE1 Extra Wide:

Overall dimensions: 94" long x 37" wide
Patient surface: 85" long x 31" wide

Transport Stretchers

Standard

Consists of standard open cell high density polyurethane foam with a Lectrolite™ Cover. Meets OEM Specifications.

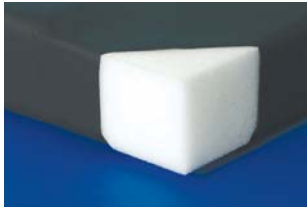

Deluxe

Consists of standard open cell high density polyurethane foam with a multi-directional stretch anti-shear Fusion™ Cover. Exceeds OEM specifications.

Softcare

Consists of high density polyurethane foam support layer with a top layer of memory foam covered with a multidirectional stretch anti-shear Fusion™ Cover. Exceeds OEM specifications.



Softcare Plus

Consists of a closed cell rubber anti-bottoming layer then a high density polyurethane foam support layer with a top layer of memory foam covered with a multidirectional stretch anti-shear Fusion™ Cover.



All of our stretcher pads can be sized to meet your specifications. Call us for a quote!

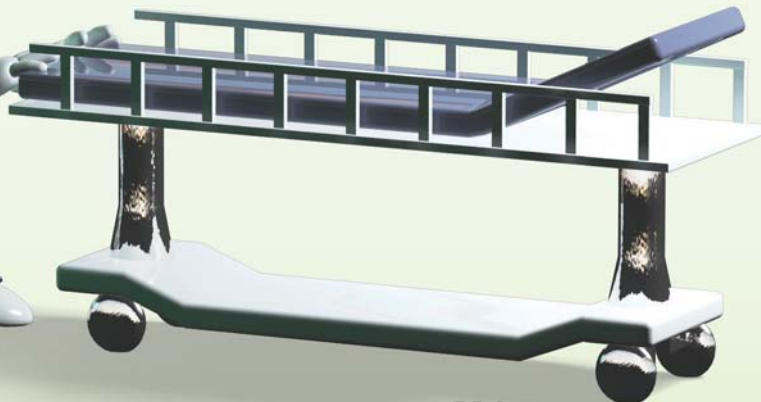

N6

Anesthesia Machines

FHC offers top quality new anesthesia machines from Penlon.

Penlon Prima 450 Anesthesia System:

- Electronic flow display & conventional flowmeter options available
- AV-S ventilator
- A200SP absorber
- Sigma Delta vaporizer
- Electronic flow display
- 6 ventilation modes
- New top shelf w/ secure GCX mounting system for patient monitors
- Territory-specific electrical outlet options
- Selectactec compatible back-bar (1 or 2 stations)
- Illuminated work space
- Large capacity drawer units
- GCX compatible aluminum uprights for additional accessory mounting
- Integrated CO2 absorber and bellows unit w/ ventilator interface
- HIS connectivity
- Intuitive design in compact footprint
- Low life costs

2 Year Warranty!



PEPRIMA450

Penlon Prima 460 Anesthesia System:

- Electronic flow display & conventional flowmeter options available
- AV-S ventilator
- A200SP absorber
- Sigma Delta vaporizer
- Electronic flow display
- 6 ventilation modes
- New top shelf w/ secure GCX mounting system for patient monitors
- Territory-specific electrical outlet options
- Selectactec compatible back-bar (2 or 3 stations) w/ interlock on 3 station option
- Up to 4 cylinders
- Illuminated work space with pull-out writing surface
- Large capacity drawer units
- GCX compatible aluminum uprights for additional accessory mounting
- Integrated CO2 absorber and bellows unit w/ ventilator interface
- HIS connectivity
- Intuitive design in compact footprint
- Low life costs

2 Year Warranty!



PEPRIMA460

Anesthesia Machines

We also carry refurbished anesthesia machines from Datex & Drager

Datex Ohmeda Aespire S/5 7900 Anesthesia Machine:

- Enhanced monitor integration capabilities with Datex-Ohmeda anesthesia monitor
- Optional integrated auxiliary O2 flowmeter and suction control/pressure waveform available
- Advanced breathing system (ABS™)
- One-step bag/vent switch turns ventilator on/off
- Minimal number of parts and tube connections greatly reduces the potential for leaks and misconnects
- Easy disassembly (no tools required)
- Fully autoclavable and latex-free
- 7900 ventilator s/n - volume and pressure modes with electronic peep
- Exhaled volume airway pressure and inspired oxygen monitoring capabilities
- Direct access to ventilator parameter settings
- Smart alarms direct user to specific problems and affected parameters
- Pressure bar graph for visual reference on a breath-by-breath basis
- Improved low flow/reduced life cycle costs
- Only one scheduled maintenance check per year



Datex Ohmeda Aestiva 5 Anesthesia Machine:

- Enhanced monitor integration
- Lightweight and compact
- Advanced breathing system
- Fully autoclavable and latex-free
- Oxygen monitoring capabilities
- Volume and pressure modes with electronic peep
- Improved low flow/reduced life cycle costs
- Superior 7900 SmartVent technology
- Optional: integrated auxiliary O2 flowmeter and suction control, and pressure waveform available



Drager Narkomed GS Anesthesia Machine:

- Air O2 & N2O flow control assembly with yokes
- Triple exclusion system absorber system complete with hoses & peep system scavenger
- O2-Med FIO2 monitor w/ new fuel cell/sensor cable
- Breathing pressure monitor
- Respiratory volume monitor
- Ave elect. ventilator w/ ascending latex-free bellows & insp. pressure limiter
- ORC O2 ratio monitor
- Drawer assembly w/ central key locking system
- Built-in monitor
- 5" casters w/ front wheel locks
- Nasal O2 flowmeter & vacuum regulator

***One year parts and labor warranty on all refurbished anesthesia machines. Excludes travel time, rubber components, monitor sensors, fuel cells, seals, gaskets and other expendable items. Anesthesia machine warranty service must be performed by FHC or an authorized agent.**

Anesthesia Machine Parts

From ventilators to vaporizers, we have all the anesthesia parts you need.



Penlon Nuffield 200 Ventilator Features:

- Pneumatically driven time-cycle ventilator
- Preset volume & flow rate for adult or pediatric
- Easy-to-use
- Compact
- Multi-use capabilities - (Co-axial circuit, Ayre's Tee Circuit, Circle System, Resuscitation)
- Use w/ Newton Valve to deliver ultra low tidal volumes for neonates/premature babies

Penlon Sigma Delta Vaporizer Features:

- Superb performance, particularly at low flow
- Four backbar mounting systems
- Multiple agent and filler block options
- Low body weight
- Key fill, Quik Fil, or Pour fill
- Sevoflurane, Isoflurane, Halothane & Enflurane
- Selectatec, Drager Plug-In, North American Drager, Cagemount
- Internationally recognized
- Award-winning design



FHC Fiber Optic Laryngoscope Blades:

- MAFO4310 - Mac #0
- MAFO4311 - Mac #1
- MAFO4312 - Mac #2
- MAFO4313 - Mac #3
- MAFO4314 - Mac #4
- MAFO4315 - Mac #5



FHC Miller, WIS & Paed Fiber Optic Blades:

- MAFO52200 - Miller #00
- MAFO5220 - Miller #0
- MAFO5221 - Miller #1
- MAFO5222 - Miller #2
- MAFO5223 - Miller #3
- MAFO5224 - Miller #4
- MAFO7230 - WIS #0
- MAFO7231 - WIS #1
- MAFO7232 - WIS #2
- MAFO7233 - WIS #3
- MAFO7234 - WIS #4
- MAFO92250 - WIS Pediatric #0
- MAFO92251 - WIS Pediatric #1
- MAFO92251.5 - WIS Pediatric #1 1/2



MAFO8102

FHC Small F.O. Battery Handle:

- Small F.O. battery handle for two AA batteries, complete



MAFO8103

FHC Stubby F.O. Battery Handle:

- Stubby fiber optic battery handle, 2.5v

We carry a full line of anesthesia parts & accessories to accommodate your needs. Ask your rep if we have what your facility needs!



Anesthesia Machine Parts

FHC Continuous Analog Vacuum Regulator Features:

- Continuous analog vacuum regulator w/ Ohmeda adapter & tubing nipple
- High (0 - 760mm)
- Easy to service and clean
- Smallest & lightest unit on the market (10oz)
- Can be easily upgraded (intermittent/digital)
- Color-coded gauges
- ABS polymer casing is impact resistant & durable
- Same housing for both continuous and intermittent
- Reinforced inlets/outlets
- Removable back plate and gasket
- Can be sterilized internally w/ cold disinfectant
- Designed to meet all current CGA, HCA, & FDA requirements
- Also available with: Chemtron, Puritan Bennet and DISS connectors

***12 Year Warranty!**



FHCVR-CHUT-OMA

FHC Continuous Digital Vacuum Regulator Features:

- Continuous analog vacuum regulator w/ Ohmeda adapter & tubing nipple
- High (0 - 760mm)
- Easy to service and clean
- Smallest & lightest unit on the market (10oz)
- Can be easily upgraded (intermittent/digital)
- Color-coded gauges
- ABS polymer casing is impact resistant & durable
- Same housing for both continuous and intermittent
- Reinforced inlets/outlets
- Removable back plate and gasket
- Can be sterilized internally w/ cold disinfectant
- Designed to meet all current CGA, HCA, & FDA requirements
- Also available with: Chemtron, Puritan Bennet and DISS connectors

***12 Year Warranty!**



FHCVR-CHUT-OMD



Intermittent also available!



Multiple Color Options!

Anesthesia Machine Parts

FHC O2 Flowmeter with Ohmeda Adapter Features:

- Available in USA and ISO colors
- Smallest and lightest chromed brass bodied flowmeter in the industry
- Color-coded inner tube and labeling
- Easy to service
- No strip "D" shape knob
- Includes an inlet filter and inlet extension
- Complete line of flowmeters from neonatal to adult
- Available in standard Thorpe style & Dial style
- Standard 1/8" FNPT connection, but may also be fitted with different adapters & accessories to customize your needs
- MRI options are available
- Smallest & lightest chromed brass bodied flowmeter in the industry
- Available with Chemtron adapter, Ohmeda adapter, Puritan Bennett adapter, and 1/8" NPT female adapter

***5 Year Warranty!**



FHCFM-15UO-OH



Dial Styles:

- Available in Oxygen in 25, 15, 8, & 4 LPM
- Available in Medical Air in 25 & 15 LPM
- Smallest and lightest in the industry
- Small increment is 1/32
- Color-coded labeling for specific gas
- Encased in a anodized aluminum housing
- Easy to read window



(Dual Outlet w/ Flowmeter)



(Dual /Y-block Flowmeter Assembly)

Accessories:



Reusable Humidifier



Disposable Humidifier



Swivels/Christmas Trees



Power Takeoff

Anesthesia Machine Parts

Bulk Hose & Hose Assemblies



Gas	Conductive	Non-Conductive	Gas	Conductive	Non-Conductive
Oxygen:	HS-01U-OC4	HS-01U-ON4	GEN 1/4":	HS-01U-GC4	HS-01U-GN4
Air:	HS-01U-AC4	HS-01U-AN4	CO2:	HS-01U-CC4	HS-01U-CN4
Vac 1/4":	HS-01U-VC4	HS-01U-VN4	WAGD 1/4":	HS-01U-EC4	N/A
Vac 5/16":	HS-01U-VC5	N/A	WAGD 5/16":	N/A	HS-01U-EN5
N20:	HS-01U-2C4	HS-01U-2N4	NIT:	HS-01U-NC4	HS-01U-NN4



Wall Mount Hoses	Hose & Connections
HS-12U0-DHOMC4	Oxygen 12 ft. w/ Diss Handtight & Ohmeda Male
HS-12U0-DHCCMC4	Oxygen 12 ft. w/ Diss Handtight & Chemetron Male
HS-12UA-DHOMC4	Medical Air 12 ft. w/ Diss Handtight & Ohmeda Male
HS-12UA-DHCCMC4	Medical Air 12 ft. w/ Diss Handtight & Chemetron Male
HS-12U2-DHOMC4	N20 12 ft. w/ Diss Handtight & Ohmeda Male
HS-12U2-DHCCMC4	N20 12 ft. w/ Diss Handtight & Chemetron Male
HS-12UV-DHCXC5	Vacuum 12 ft. w/ Diss Handtight & Blank
HS-12UV-DHOMC5	Vacuum 12 ft. w/ Diss Handtight & Ohmeda Male
HS-12UV-OMXC5	Vacuum 12 ft. W/ Ohmeda Male & Blank
HS-12UV-CMXC5	Vacuum 12 ft. w/ Chemetron Male & Blank
HS-12UV-DHDHC5	Vacuum 12 ft. w/ Diss Handtight & Diss Handtight

Anesthesia Machine Parts

From ventilators to vaporizers, we have all the anesthesia parts you need.

OHMEDA Adapters

	 OXYGEN	 MEDICAL AIR	 VACUUM	 N ₂ O	 WAGD	 CO ₂
 1/8" NPT Male	AMAD-OHUO-M2	AMAD-OHUA-M2	AMAD-OHUV-M2	AMAD-OHU2-M2	AMAD-OHUW-M2	AMAD-OHUC-M2
 1/4" Hose Barb 5/16" Hose Barb	AMAD-OHUO-HB4	AMAD-OHUA-HB4	AMAD-OHUV-HB4 AMAD-OHUV-HB5	AMAD-OHU2-HB4	AMAD-OHUW-HB4 AMAD-OHUW-HB5	AMAD-OHUC-HB4
 DISS Male	AMAD-OHUO-DM	AMAD-OHUA-DM	AMAD-OHUV-DM	AMAD-OHU2-DM	AMAD-OHUW-DM	AMAD-OHUC-DM
 1/4" NPT Male	AMAD-OHUO-M4	AMAD-OHUA-M4	AMAD-OHUV-M4	AMAD-OHU2-M4	AMAD-OHUW-M4	AMAD-OHUC-M4
 1/8" NPT Female	AMAD-OHUO-F2	AMAD-OHUA-F2	AMAD-OHUV-F2	AMAD-OHU2-F2	AMAD-OHUW-F2	AMAD-OHUC-F2
 DISS Handtight	AMAD-OHUO-DH	AMAD-OHUA-DH	AMAD-OHUV-DH	AMAD-OHU2-DH	AMAD-OHUW-DH	AMAD-OHUC-DH
 DISS Nut & Nipple	AMAD-OHUO-DN	AMAD-OHUA-DN	AMAD-OHUV-DN	AMAD-OHU2-DN	AMAD-OHUW-DN	AMAD-OHUC-DN

Anesthesia Machine Parts













OHMEDA Couplers

	 OXYGEN	 MEDICAL AIR	 VACUUM	 N ₂ O	 WAGD	 CO ₂
 1/8" NPT Male	AMCO-OHUO-M2	AMCO-OHUA-M2	AMCO-OHUV-M2	AMCO-OHU2-M2	AMCO-OHUW-M2	AMCO-OHUC-M2
 1/4" Hose Barb 5/16" Hose Barb	AMCO-OHUO-HB4	AMCO-OHUA-HB4	AMCO-OHUV-HB4 AMCO-OHUV-HB5	AMCO-OHU2-HB4	AMCO-OHUW-HB4 AMCO-OHUW-HB5	AMCO-OHUC-HB4
 DISS Male	AMCO-OHUO-DM	AMCO-OHUA-DM	AMCO-OHUV-DM	AMCO-OHU2-DM	AMCO-OHUW-DM	AMCO-OHUC-DM
 1/4" NPT Male	AMCO-OHUO-M4	AMCO-OHUA-M4	AMCO-OHUV-M4	AMCO-OHU2-M4	AMCO-OHUW-M4	AMCO-OHUC-M4
 1/8" NPT Female	AMCO-OHUO-F2	AMCO-OHUA-F2	AMCO-OHUV-F2	AMCO-OHU2-F2	AMCO-OHUW-F2	AMCO-OHUC-F2
 DISS Handtight	AMCO-OHUO-DH	AMCO-OHUA-DH	AMCO-OHUV-DH	AMCO-OHU2-DH	AMCO-OHUW-DH	AMCO-OHUC-DH
 DISS Nut & Nipple	AMCO-OHUO-DN	AMCO-OHUA-DN	AMCO-OHUV-DN	AMCO-OHU2-DN	AMCO-OHUW-DN	AMCO-OHUC-DN

Anesthesia Machine Parts

From ventilators to vaporizers, we have all the anesthesia parts you need.

CHEMETRON Adapters

	 OXYGEN	 MEDICAL AIR	 VACUUM	 N ₂ O	 WAGD	 CO ₂
 1/8" NPT Male	AMAD-CHUO-M2	AMAD-CHUA-M2	AMAD-CHUV-M2	AMAD-CHU2-M2	AMAD-CHUW-M2	AMAD-CHUC-M2
 1/4" Hose Barb 5/16" Hose Barb	AMAD-CHUO-HB4	AMAD-CHUA-HB4	AMAD-CHUV-HB4 AMAD-CHUV-HB5	AMAD-CHU2-HB4	AMAD-CHUW-HB4 AMAD-CHUW-HB5	AMAD-CHUC-HB4
 DISS Male	AMAD-CHUO-DM	AMAD-CHUA-DM	AMAD-CHUV-DM	AMAD-CHU2-DM	AMAD-CHUW-DM	AMAD-CHUC-DM
 1/4" NPT Male	AMAD-CHUO-M4	AMAD-CHUA-M4	AMAD-CHUV-M4	AMAD-CHU2-M4	AMAD-CHUW-M4	AMAD-CHUC-M4
 1/8" NPT Female	AMAD-CHUO-F2	AMAD-CHUA-F2	AMAD-CHUV-F2	AMAD-CHU2-F2	AMAD-CHUW-F2	AMAD-CHUC-F2
 DISS Handtight	AMAD-CHUO-DH	AMAD-CHUA-DH	AMAD-CHUV-DH	AMAD-CHU2-DH	AMAD-CHUW-DH	AMAD-CHUC-DH
 DISS Nut & Nipple	AMAD-CHUO-DN	AMAD-CHUA-DN	AMAD-CHUV-DN	AMAD-CHU2-DN	AMAD-CHUW-DN	AMAD-CHUC-DN

Anesthesia Machine Parts

CHEMETRON Couplers

	 OXYGEN	 MEDICAL AIR	 VACUUM	 N ₂ O	 WAGD	 CO ₂
 1/8" NPT Male	AMCO-CHUO-M2	AMCO-CHUA-M2	AMCO-CHUV-M2	AMCO-CHU2-M2	AMCO-CHUW-M2	AMCO-CHUC-M2
 1/4" Hose Barb 5/16" Hose Barb	AMCO-CHUO-HB4	AMCO-CHUA-HB4	AMCO-CHUV-HB4 AMCO-CHUV-HB5	AMCO-CHU2-HB4	AMCO-CHUW-HB4 AMCO-CHUW-HB5	AMCO-CHUC-HB4
 DISS Male	AMCO-CHUO-DM	AMCO-CHUA-DM	AMCO-CHUV-DM	AMCO-CHU2-DM	AMCO-CHUW-DM	AMCO-CHUC-DM
 1/4" NPT Male	AMCO-CHUO-M4	AMCO-CHUA-M4	AMCO-CHUV-M4	AMCO-CHU2-M4	AMCO-CHUW-M4	AMCO-CHUC-M4
 1/8" NPT Female	AMCO-CHUO-F2	AMCO-CHUA-F2	AMCO-CHUV-F2	AMCO-CHU2-F2	AMCO-CHUW-F2	AMCO-CHUC-F2
 DISS Handtight	AMCO-CHUO-DH	AMCO-CHUA-DH	AMCO-CHUV-DH	AMCO-CHU2-DH	AMCO-CHUW-DH	AMCO-CHUC-DH
 DISS Nut & Nipple	AMCO-CHUO-DN	AMCO-CHUA-DN	AMCO-CHUV-DN	AMCO-CHU2-DN	AMCO-CHUW-DN	AMCO-CHUC-DN

Defibrillators

A Defibrillator for Every Application—One User Interface



Accessories Available!



Future Health Concepts offers a full line of new and factory refurbished Zoll defibrillators with a large variety of parameters available to accommodate any patient. All of our refurbished defibrillators come as **Factory Demo** to provide customers with the new product quality, at a competitively low price.



Defibrillators

ZOMBP

Zoll M Series Biphasic Defibrillator w/ Pacing

GENERAL

Size: 6.8" (17.3 cm) H x 10.3" (26.2 cm) W x 8.2" (20.8 cm) D
 Weight: 11.5 lbs (5.23 kg) with Multi-Function Cable and battery;
 13.5 lbs (6.14 kg) with paddles
 Design Standards: Meets or Exceeds UL Standards

ECG MONITORING

Patient Connection: 3, 5 or 12 -lead ECG cable, paddles or MFE Pads.
 Bandwidth: 0.5-40 Hz (-3 dB) or 0.5-30 Hz; 0.05-150Hz diagnostic
 ECG Size: 0.5, 1, 1.5, 2, 3 cm/ mV – display on monitor
 Heart Rate: Digital display 0-3000 bpm \pm 5%

DISPLAY

Screen Type: High-resolution display
 Screen Size: 5.6" (14.2cm) diagonally
 Sweep Speed: 25mm/ sec
 Viewing Time: 4 seconds
 Channels: 2

DEFIBRILLATOR

Waveform: Damped Sinusoid or Zoll Rectilinear Biphasic
 Energy Selection: Selectable 1, 2, 3, 4, 5, 6, 7, 8, 9, 10, 15, 20, 30, 50, 75, 100, 150, 200, 300, 360 joules. (Delivered into 50 Ω load.)
 Charge Time: Less than 7 seconds with new fully charged battery
 Paddles: External anterior/ anterior adult and pediatric



ZOMCCTBPSNI

Zoll M Series Bi-Phase Defibrillator w/ SPO2, NIBP, IBP Advisory AED

ZOLL XL Battery for long transport times
 Transport-ready design
 Easy-to-read display
 Full range of parameters for a full range of patients
 Flexible color display
 Quick, easy connections
 Ready to gather and share critical data



ZOAED-PLUS

Zoll Defibrillator : AED Plus

Lightweight 6.7lbs
 Easily identifiable green exterior
 Uses low cost consumer batteries
 Voice prompts provide feedback and encouragement
 LED lights show rescuers proper steps in order
 One piece CDR-D padz



FHC-LIFEPAK12-B

Physio Control Lifepak 12 Biphasic Defibrillator w/ Pacing

Compact and portable
 Choice of standard paddles, pediatric paddles, and/or sterilizable internal and external paddles
 Compatible with QUIK-COMBO® pacing/defibrillation/ECG electrodes
 Masimo SET® pulse oximetry offers accurate and stable oxygen saturation monitoring
 Oscillometric (NIBP) monitoring
 End-tidal CO2 (EtCO2) monitor
 GE Marquette 12SL™ ECG analysis program
 Either 50mm or 100mm printers
 Data Storage: Up to 50 patient records

Patient Monitors

FHC offers a full line of vital sign & anesthesia monitoring.



LAF3-86-390-0910-97

Star 60 Color Patient Monitor:

- 10.4" High resolution backlit LED display
- 6-channel Multi-parameter monitor
- Standard parameters: ECG, respiration, dual temperature, NiBP, SpO2 (Nellcor), IBP
- Upgradable to (internal/external), Microstream EtCO2 (with IPI™)
- ST segment analysis && Arrhythmia detection
- Advanced alarm management system including Satseconds™
- WiFi connectivity with Central Nursing Station (Optional)

Star 90 Color Patient Monitor:

- 10 channel sleek, slim monitor
- 15" high resolution (touch) color backlit LED display
- Modular form with inbuilt rack
- Basic configuration: ECG, SpO2, NiBP, dual temperature, dual IBP, respiration
- OxyCRG & Drug dose calculation
- Multiple screen formats w/ auto-format screen
- Adult, pediatric and neonatal applications
- 240 hours of graphical & tabular trends
- External modules and host of pluggable device connectivity
- 2 hours of battery backup
- 24 hrs waveform storage and download
- Specialty module options: NiCCO, EtCO2 (with IPI™)
- WiFi ready
- Wireless connectivity to CNS Skyline 55 & Skyview mini
- Eco-friendly data manager
- Advanced alarm management system



LAF3-99-390-0136-37

Patient Monitors

AGM 55 Module:

- Anesthesia gas monitoring module
- Compatible with Star 90 and Star 55 monitors
- Detection of 5 agents and 3 gases
- Auto detection of primary and secondary agents
- Measurement and display of MAC value

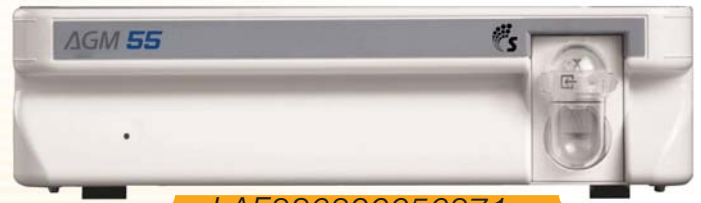

LAF386390056371

SpotSkan Spot-Check Vital Sign Monitor:

- 6.5" color TFT display
- Capacitive touch keypad
- SpO2 with Plethbar
- Quick temperature measurement
- NiBP measurement
- Pulse rate from SpO2/NiBP
- Adult and pediatric applications
- 12 patients' history storage
- Thermal recorder printer
- Battery back-up



LAF3-85-390-0335-13



**Don't see a monitor you like?
Call a sales rep and ask to see
our full patient monitor line to
ensure you get the right patient
monitor you need for your
facility!**

Monitor Stands & Mounts

Medical Monitor Stands:

- Load capacity up to 25 lbs.
- Overall height: 42"
- Sturdy 25" base
- 3" locking casters
- 5" slide-in monitoring plate or VESA 75/100 plate
- Optional accessories available

Part #'s:

- Planet 55 - LAFSTAND-55
- Planet - LAFSTAND-P
- Star - LAFSTAND
- Stellar - LAFSTAND-S

***5 Year Warranty!**



AMSSM-150

FHC 22" Double Pivot Monitor Arm:

- 22" extension
- 30 lb. arm rating
- $\pm 30^\circ$ tilt
- Integrated & intelligent cable management
- Tilt and swivel adjustments
- Swivel arm provides lateral functionality
- Compatible w/ Ergotron & Rubbermaid computer carts

***5 Year Warranty**



AMSSM-350

FHC 16" Double Pivot Monitor Arm:

- 16" extension
- 30 lb. arm rating
- $\pm 30^\circ$ tilt
- Integrated & intelligent cable management
- Tilt and swivel adjustments
- Swivel arm provides lateral functionality
- Compatible w/ Ergotron & Rubbermaid computer carts

***5 Year Warranty**



AMSSM-050

FHC Monitor Arm:

- 9" or 12" single arm lengths
- Available for wall channel or rail mounting
- 60 lb. arm rating
- Integrated & intelligent cable management
- Tilt and swivel adjustments
- Swivel arm provides lateral functionality
- Color options available (white is standard)

***5 Year Warranty**

Stainless Steel Cabinetry

At FHC, we offer complete customization to fit any special requests or requirements that the customer needs, at a competitive price. We use fully engineered CAD renderings to supply perfection and accuracy in every aspect. With fully-welded construction and top quality stainless steel, our cabinets are built for long-lasting durability and reliability. Whether it's Supply Storage, Nurse Documentation, or Overhead Storage, we have the equipment you can count on.

Supply Storage Cabinets:

Standard Features:

- Fully-welded construction
- Multiple layouts for individual requirements
- Full CAD renderings
- Engineered room layouts in CAD

Options:

- Glass or stainless steel hinged doors
- Glass or stainless steel sliding doors
- Freestanding, recess or on casters
- T-handle locks
- Pegboard back
- Drawers
- Variable height bases
- Slope tops
- Electronic keypad door locks
- Pull out catheter hooks with card holder
- Pass through construction

Standard Sizes:

- Depths: 18" and 24"
- Widths: 24", 30", 36", 48" and 60"
- Flat top heights: 60", 64", 72", 78" and 84"
- Slope top heights: 70", 78", 84" and 90"

Freestanding cabinet w/ hinge glass doors



Freestanding cabinet w/ sliding glass doors

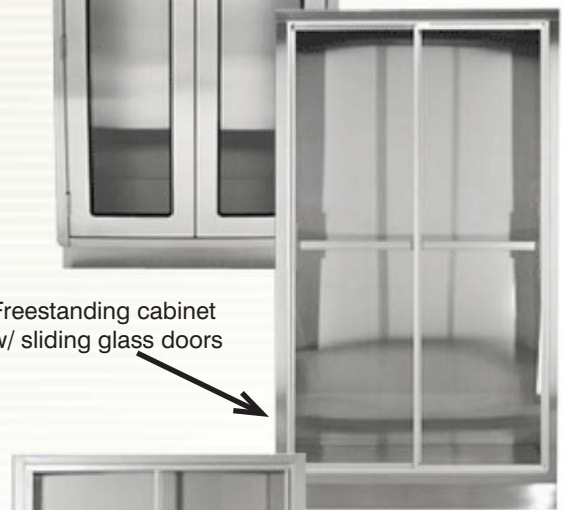

Recessed cabinet w/ sliding glass doors



Custom sizes available upon request

Stainless Steel Cabinetry

Sample Supply Storage Cabinet:

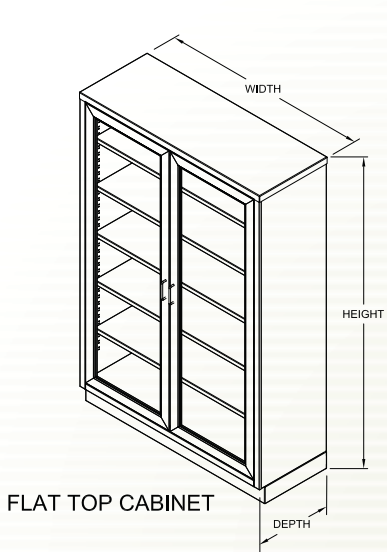

FLAT TOP CABINET

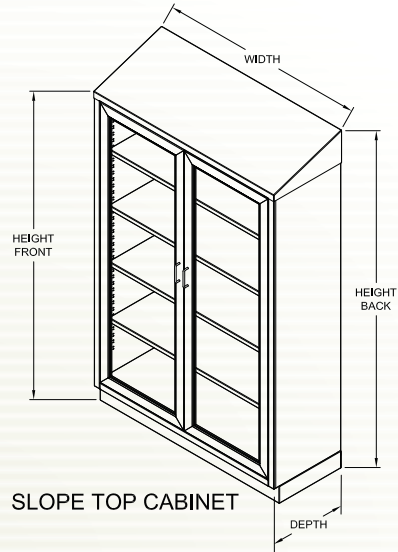

SLOPE TOP CABINET

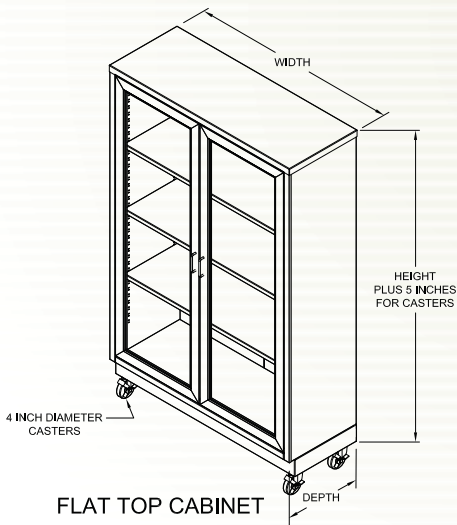

FLAT TOP CABINET

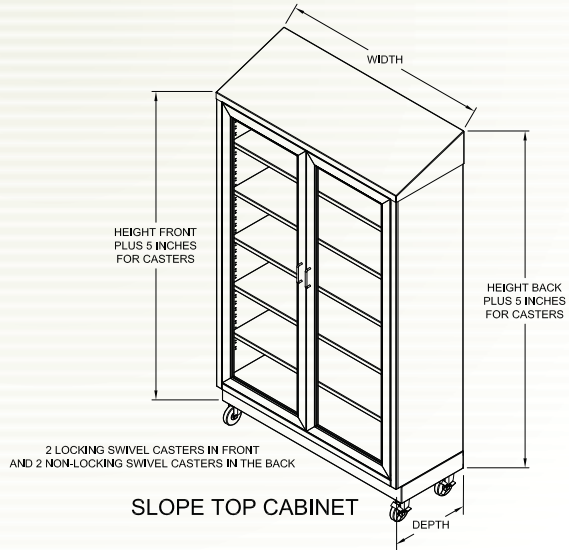

SLOPE TOP CABINET

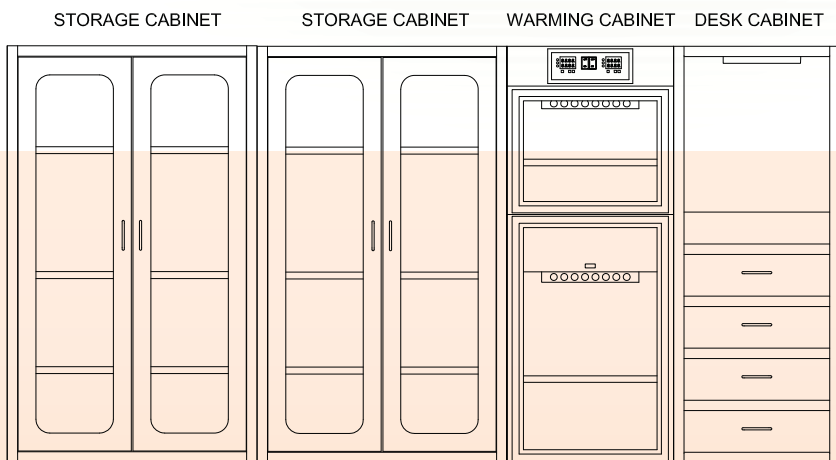

ANY COMBINATION OF STORAGE CABINETS, DESK CABINETS, AND WARMING CABINETS CAN CREATE A CONTINUOUS BANK OF CABINETS.

Stainless Steel Cabinetry

Nurse Documentation Stations:

Standard Features:

- Fully-welded construction
- Recess or free standing
- Multiple layouts for individual requirements
- Heavy duty pull out drawers
- Vented closures for electronics
- Integrated wire management system
- Open backs for easy install
- Pull out shelf for easy PC install
- Base units, wall units and overhead units available
- Full CAD renderings
- Engineered room layouts in CAD



Options:

- Glass or stainless steel doors
- Pull out writing surface
- Overhead lighting
- Magnetic back board
- Pegboard panels
- Recess or freestanding
- T-handle locks
- Variable height bases
- Electronics keypad door locks

Custom sizes available upon request

Overhead Storage Cabinets:

Standard Features:

- Fully-welded construction
- Multiple layouts for individual requirements
- Full CAD renderings
- Engineered room layouts in CAD

Options:

- Glass or stainless steel doors
- Sliding glass doors
- T-handle locks
- Pegboard back
- Drawers
- Slope tops
- Electronics keypad door locks
- Pass through construction



Stainless Steel Cabinetry

Sample Nurse Documentation Station:

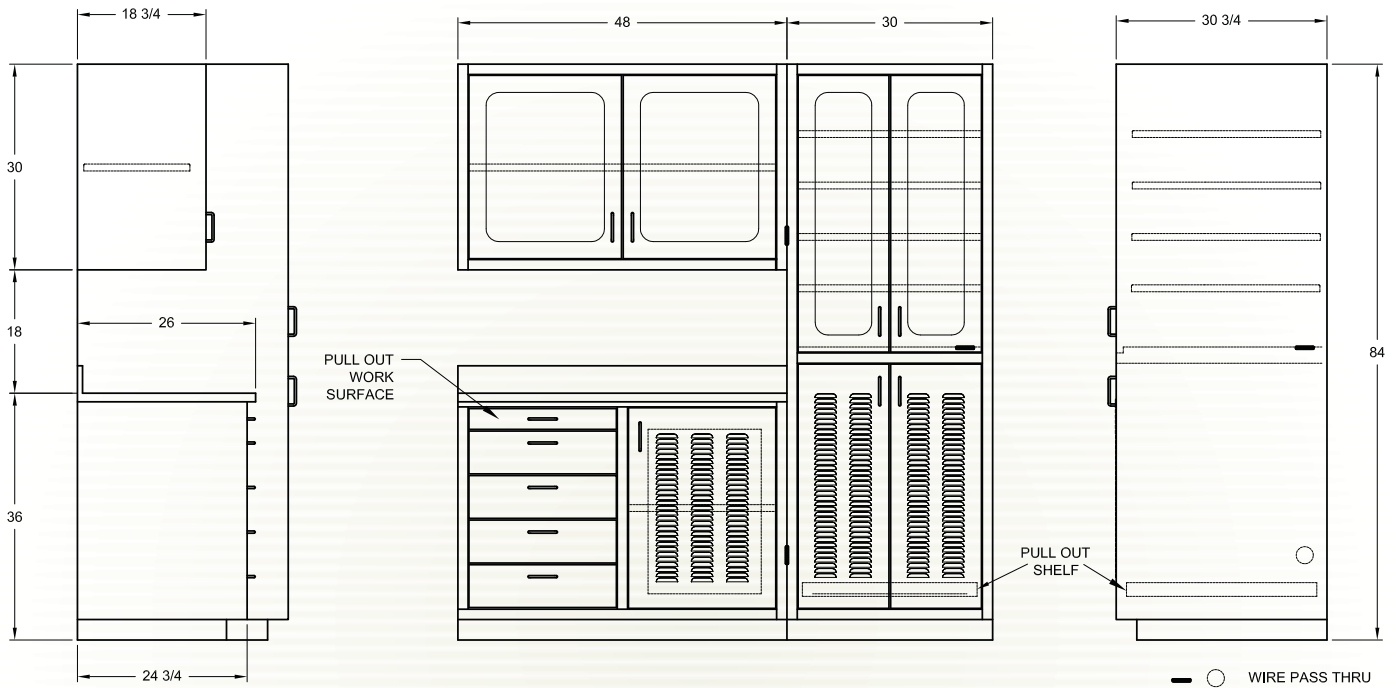

DOCUMENTATION SHOWN WITH TOWER ON THE RIGHT SIDE.
DOCUMENTATION STATION CAN BE CONFIGURED WITH THE TOWER ON THE LEFT SIDE.

WE CAN CUSTOMIZE ANY COMPONENT OF THIS DOCUMENT STATION
TO FIT A SPECIFIC SPACE OR USER REQUIREMENT.

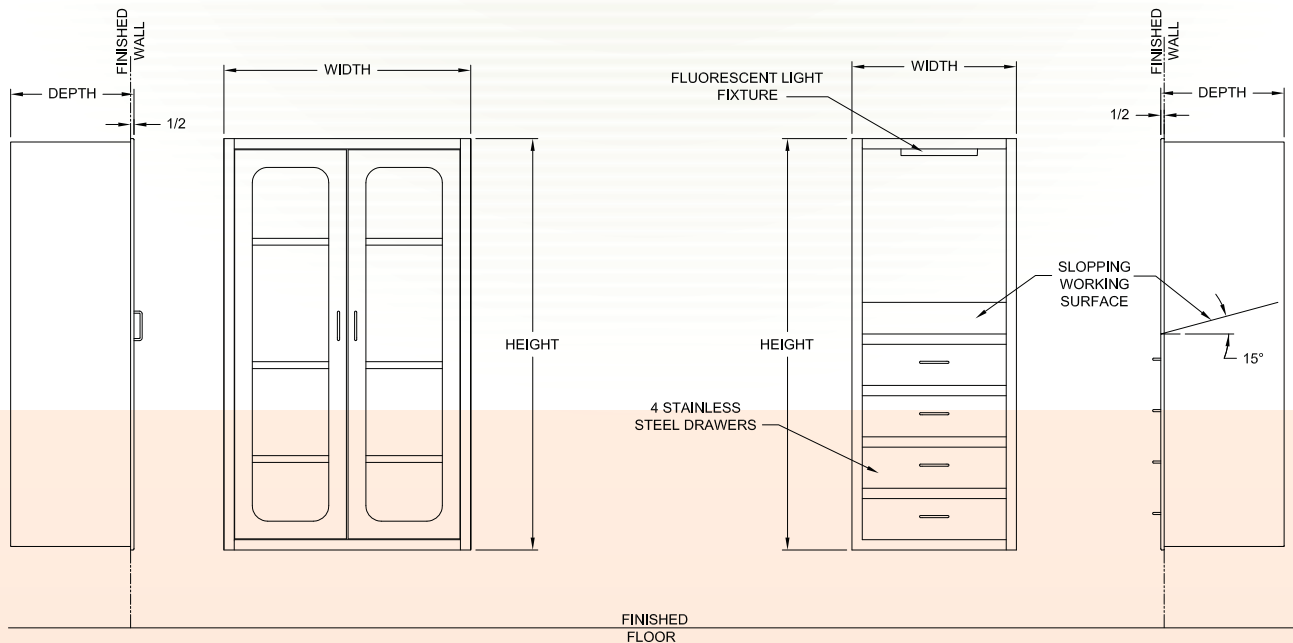

STANDARD SIZES
DEPTH 16", 18", 24"
WIDTHS 24", 30", 36", 48", 60"
HEIGHTS 60", 72"

ANY SIZE CAN BE MANUFACTURED PER REQUIRED SPECIFICATION

STANDARD SIZES
DEPTH 16", 18", 24"
WIDTHS 24", 30", 36"
HEIGHTS 60", 72"

ANY SIZE CAN BE MANUFACTURED PER REQUIRED SPECIFICATION

Storage/Organization

Call us for custom sizes and specifications on your storage needs!

AkroBins:

- Multiple sizes and colors allow color coding (vertically and horizontally) and easy identification
- Molded of industrial-grade polymers
- Bins sit on shelves or hang from Akro-Mils panels, racks, rails and carts
- AkroBins stack securely to optimize shelf space
- Bins feature wide hopper fronts for easy access
- Available in 11 colors including clear



Super-Size AkroBins:

- Perfect for organizing and protecting large or bulky items
- Heavy-duty bins stack securely atop each other or sit on shelving
- Molded of industrial-grade polymers
- Window inserts and dividers available for expanded storage options
- Available in 12 sizes and 4 colors: red, blue, yellow or clear

InSight Bins:

- Provides easy and maximum visibility
- Can stack, sit on shelving or hang on Akro-Mils rails, louvered panels or ReadySpace Storage Systems
- Optional lids protect contents from dust - stack with lids in place
- No-tip feature when bins are stacked
- Large label area for part identification and bar code scanning
- Clear length and width dividers available
- Autoclavable
- Available in 4 sizes



Storage/Organization

ShelfMax Bins:

- 6" tall bins to increase storage capacity up to 85%
- Front opening is .75" higher than comparable products
- Superior, durable construction
- Width dividers keep items neatly separated
- Rolled ridge for added strength when filled
- Can be used alone or with Akro-Mil's open or closed steel shelving, wire shelving, bench racks, or pick racks
- 12 sizes and 6 color options: red, blue, yellow, green, white or clear



Shelf Bins:

- Keep supplies neat and organized
- Create cleaner work areas
- Easy to label and color code
- Works with 12", 18" and 24" deep shelving
- Durable, one-piece construction
- Bins nest when empty for space saving
- 13 sizes and 6 color options: red, blue, yellow, green, white or clear

AkroDrawers:

- Available in 9 sizes and 5 colors including crystal clear
- Colors made of high-impact polystyrene
- Crystal clear drawers made of durable acrylic blend
- Offered in 12", 18" or 24" depths to work with shelving
- Easy to label and color code inventory
- Wide front handles for easy gripping
- Dividers available to keep contents separated
- Drawers fit securely in cabinets or enclosed steel shelving for dust-free storage



Storage/Organization

Louvered Carts:

- Industrial-grade mobile workstation with a welded-steel frame and steel-reinforced butcher block work surface
- Available in two worktop sizes: 49”L x 24”W and 37”L x 18”W
- Made from 16-gauge steel with durable powder-coated finish
- Non-marking blue elastic rubber casters allow a weight capacity of 800 lbs.



Super Modular Cabinets:

- Organize your AkroDrawers on specially designed stackable or wall-mountable cabinets
- AkroDrawers fit snugly on shelves so open top is protected from dust and debris
- Drawers hang securely from shelves by sturdy backstop tab
- 11” cabinets can be mounted to wall
- Durable powder-coated finish
- Weight capacity: 60 lbs 18” Cabinets; 75 lbs. 24” Cabinets; combined stack weight cap. 100 lbs

ProCart:

- Versatile, all-purpose cart
- Deep, molded-in compartments keep small items in reach
- AkroBins can be mounted under cart using the 9-Rail System
- 11” Deep Super Modular Cabinets can be mounted on two rails under ProCart on either side or on one side.



Storage/Organization

Stackable Cabinets:

- Increased storage capacity for AkroDrawers
- Available in 2 sizes - one for 12" AkroDrawers and one for 18" AkroDrawers
- Optional 8" high base stands raise cabinets off the floor
- Durable powder-coated finish
- Units can be safely stacked up to three high

AKAD3511PAST

AKAD3517PAST

AKAD3517BSP



AKO6704

TiltView:

- Space-saving system for improved organization and efficiency
- Can be used on a desktop, attached to steel rails, frames, or louvered panels, and are wall mountable
- Cabinets made of high-impact polystyrene; bins made of polystyrene (GPS)
- Available in 6 sizes

Heavy-Duty Lockable Bin Cabinets:

- All-welded 16-gauge steel construction with 7-gauge reinforced corners
- Heavy-duty steel padlock-ready handle ensures complete security to prevent damage or theft
- Louvered doors expand organizing options using AkroBins



AKHD4824TVABBE

Storage/Organization

Quick-View Security Bin Cabinets:

- Lexan™ door panels allow easy viewing
- Keyed handle with 3-point locking system for total security
- Purchase as complete kit using AkroBins or TiltView Bins
- All-welded 16-gauge steel construction
- Keyed handle (2 keys included)



AKAC3618QV240

Akro-Grids:

- Lightweight grid containers can be customized with optional lengthwise and crosswise dividers
- Great for organizing items and creating kits of items that are used together
- 4 colors available for color coding
- 9 sizes; same footprint models are stackable
- Also available in clear



AK33166

AK33220

AK33168

System Bins:

- Convenient 6-bin unit
- Unique-one piece design, 33"W x 5"H
- Wide hopper front allows for easy access
- Smooth surfaces are easy to fill, handle and keep clean
- Designed to fit in cabinets, drawers and on 36" wide shelving
- Cost-efficient alternative to flimsy cardboard boxes
- Optional dividers available



AK30312

Storage/Organization

Stak-N-Store Bins:

- Stacking bins are ideal for large, bulky items
- Eliminate corrugated containers from storage areas
- Same size bins can be stacked atop one another on flooring or shelving
- Easy to label
- Available in 3 sizes and 5 colors: red, blue, gray, white or clear



Secure Mini-Cabinets:

- Lockable cabinet provides secure storage
- Wall mountable
- 4 adjustable shelves w/ fully louvered panel built into back for hanging AkroBins
- Available with quick-view door or solid door
- Foam gasket around door frame seals out dust
- 18-gauge steel cabinet has a welded frame and durable powder-coated finish

19-Series Steel Storage Cabinets:

- Great for organizing dental or lab supplies
- Helps to keep inventory accurate and dust-free
- Clear windows provide easy visibility of contents
- One model available with a locking door
- Stackable, wall mountable or can be used on 36" wide shelving
- Steel frame with full steel shelf under each row of drawers
- 5 drawer colors: red, blue, black, yellow, gray



Storage/Organization

ReadySpace Storage System:

- Offered in 3 configurations: wall unit, bench unit, and mobile floor unit
- Customer-friendly appearance
- Keep supplies organized and readily available
- Utilizes valuable floor or wall space that might otherwise be wasted
- Bench and mobile floor units can create a privacy wall where needed



Louvered Panels/Bench Racks:

- Offer the ultimate in storage flexibility
- Secure stationary racks to the wall or floor and wall-mounted panels to a solid structure
- Models are available to accommodate up to 288 AkroBins
- Formed from 16-gauge cold-rolled steel for strength and durability

1800 Series AkroBins:

- Storage system for long and bulky items
- Strong, durable-molded of industrial-grade polymers
- Stackable with reinforcing ribs to prevent spreading under heavy loads
- Front and back finger grips for easy handling
- One black width divider included per bin



Storage/Organization

Suture Carts:

- Open wire design and slope of shelves allow instant identification and reduces dirt and dust build-up
- Chrome plated wire shelves, including 3 dividers
- Easy assembly without any tools
- Provided with 4 or 5 wire shelves, each adjustable on 1" vertical increments
- All shelves and truss braces are chrome plated.
- Posts are chrome plated with a 1" diameter and 16-gauge steel tubular wall
- 5" chrome plated swivel casters
- Optional additional dividers and shelves available



Cassette Transfer Carts:

- Patented QuadTruss® design makes shelves up to 25% stronger
- Ideal for transport for any hospital with a unit dose medication system
- Up to 8 cassettes, in variety of sizes can be stored on the cart
- Cart has safety edges, free of bacteria-gathering crevices
- Dolly frame with wraparound bumper
- 6" casters
- 3 - 24" x 48" chrome-plated wire shelves mounted to dolly base
- Enclosure panels provide support transporting cassettes safely
- Overall dimensions: 29 3/4"D x 52 7/8"L x 71 3/8"T
- Other sizes available



Storage/Organization

Please call us for complete model numbers.

Stem Caster Carts:

- Open-wire construction to reduce dust build-up
- Variety of 5" x 1 1/4" casters available
- Four 63" posts
- Four shelves
- Plastic split sleeves
- Donut bumpers
- 68" overall height
- Fast assembly without tools
- Available in many different sizes



Sterile Wrap Carts:

- Provide safe and convenient place to hang or store wraps
- Bottom wire can be used to hold extra or odd size wraps
- Carrier assembly supports the bar and is adjustable in 1" increments along the height of the posts
- All models come standard with four square horizontal bars; additional bars can be added as accessories
- 5" swivel casters for easy maneuverability
- Available in two lengths: 48" and 60" (60" will hold wrap up to 54" x 72")
- All models are 68" in overall height
- Units have four 1" diameter posts with grooves numbered in 1" increments
- 5" swivel chrome-plated with polyurethane tread
- Chrome-plated bottom wire shelf
- 3 sided chrome-plated top & intermediate channel frames



(Shown w/ optional bins)

Storage/Organization

QuadAdjust™ Wire Shelving:

- Patented QuadTruss® shelves for increased strength and durability
- Shelves feature special interlocking corners that fit in slots of collars mounted to split sleeve
- Tapered split sleeves create a positive lock that becomes stronger as the load increases
- Posts numbered in increments of 1" for fast and level assembly
- Leveling feet are provided to help compensate for uneven floor surfaces
- Shelf utilizes a pincer-type design with the mat wire sandwiched between the two top truss wires for significant strength and distributing loads w/o stress



ECDS Series Exchange Carts:

- 5 chrome-plated wire shelves
- 1 stainless steel solid shelf
- Chrome-plated 63" posts
- Chrome dolly frame with wraparound bumper
- 6" polyurethane caster, two with brake
- 1 slide assembly
- 2 tote boxes 6" deep with box dividers
- 2 or 3 shelf dividers
- 6 plastic shelf markers



Storage/Organization

ECES Series Exchange Carts:

- 5 chrome-plated wire shelves
- 1 stainless steel solid shelf
- Chrome-plated 63" posts
- Chrome dolly frame with wraparound bumper
- 6" polyurethane casters, 2 with brake
- 1 slide assembly
- 2 tote boxes 6" deep with box dividers
- 2 or 4 shelf dividers
- 6 plastic shelf markers



ECT Series Exchange Carts:

- 4 chrome-plated wire shelves
- Choice of chrome-plated wire or stainless steel solid 5th shelf
- Chrome-plated 63" posts
- 1 slide assembly
- 2 tote boxes 6" deep with box dividers
- 5" resilient stem casters, 2 with brake
- 6 plastic shelf markets



Storage/Organization

EC Series Exchange Carts:

- 5 chrome-plated wire shelves
- Chrome-plated 63" posts
- 5" resilient stem casters, 2 with brake
- 6 plastic shelf markers



ECE Series Exchange Carts:

- 5 chrome-plated wire shelves
- Chrome-plated 63" posts
- Chrome dolly frame with wraparound bumper
- 8" polyurethane casters, 2 with brake
- Side and back enclosure panels
- 1 or 2 slide assemblies
- 2 or 4 tote boxes 6" deep with box dividers
- 4 or 6 shelf dividers
- 12 plastic shelf markers



Storage/Organization

ECD Series Exchange Carts:

- 5 chrome-plated wire shelves
- Chrome-plated 63" posts
- Chrome dolly frame with wraparound bumper
- 6" polyurethane casters, 2 with brake
- 1 slide assembly
- 2 tote boxes 6" deep with dividers
- 2 or 3 shelf dividers
- 6 plastic shelf markers



ECS Series Exchange Carts:

- 4 chrome-plated wire shelves
- 1 stainless steel solid shelf
- Chrome-plated 63" posts
- 5" resilient stem casters, 2 with brake
- 6 plastic shelf markers



Storage/Organization

ECDT Series Exchange Carts:

- 5 chrome-plated wire shelves
- Chrome-plated 63" posts
- Chrome dolly frame with wraparound bumper
- 6" polyurethane casters, 2 with brake
- 3 slide assemblies
- 6 tote boxes with box dividers
- 3 shelf dividers
- 6 plastic shelf markers



ECD7/ECE7 Series Exchange Carts:

- 4 chrome-plated wire shelves
- Choice of chrome-plated wire or stainless steel solid 5th shelf
- Chrome-plated 63" posts
- 3 slide assemblies
- 8" polyurethane casters, 2 with brake
- 3 slide assemblies
- 7 tote boxes with snap-on card holders and box dividers
- 12 plastic shelf markers



Storage/Organization

Burn-In Carts:

- Ideal for use as simple testing and preparation station for electronic products
- Also for transporting products to and from testing areas
- Includes four 24" x 60" shelves
- Shelves feature QuadTruss® design making shelves up to 25% stronger and provide built-in retaining ledge
- 5" diameter swivel casters with resilient tread and donut bumpers
- Power harness is standard and features 4 full-length strips (1 per shelf, each w/ 9 outlets) and NEMA 5-15P plug. Single and 4 strip replacement power harness available



Linen Carts:

- Carts can be altered to meet changing requirements by adding or removing accessories. Any number of combinations can be made to customize any linen cart for specific use
- Numerically calibrated grooved posts, tapered split sleeves and shelf collars combine to make shelving assembly a simple 2-step exercise
- Open-wire construction promotes higher visibility by allowing light to pass through the shelves, permits greater air circulation which helps reduce dust and contamination build-up, and increases the effectiveness of fire-suppression systems
- Posts are numbered on vertical 1" increments to ensure fast and level assembly
- All components are chrome-plated



Storage/Organization

Catheter Procedure Carts:

- QuadTruss® design makes shelves up to 25% stronger and provides a retaining ledge for increased storage stability and product retention
- Combination of hooks, shelves, and tote boxes give the versatility to hold all sizes and styles of catheter packages
- Adjustable components, shelves are vertically adjustable on 1" increments
- Hooks, shelf dividers, and tote boxes allow for easy organization
- Label holders provided to help in organization of inventory
- 5" diameter swivel casters with polyurethane tread, 2 with brakes



Inhalation Therapy Carts:

- QuadTruss® design makes shelves up to 25% stronger and provides a retaining ledge for increased storage stability and product retention
- Top and bottom inserts are PVC coated for noise and vibration reduction
- Chrome finished handles, frames, and bottom shelf
- Aluminum split sleeves and conductive casters reduce static and electrical charge
- Each PVC-coated insert has 12 compartments, each measuring 4 1/2" square
- UL-recognized 5" diameter conductive casters, 2 with brakes
- Easy assembly and adjusted without use of tools



Don't forget to ask about our 100% polyester cart covers to prevent airborne contaminants from resting on cart items!

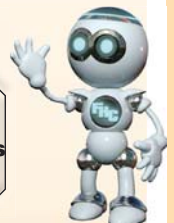

Surgical Case Carts



Standard Features:

- Fully-welded construction
- Sound-proofed tops and doors for quiet operation
- 8.5" x 11" card holder
- Adjustable perforated stainless steel roll out shelves
- Exterior push handles for better control and more interior space
- Non marring wrap-around bumper
- Positive lock door latches
- Sealed doors for sterility control
- Stainless steel casters
- Large 6" diameter, easy rolling, cart-washable casters with sealed bearings

Options:

- Fully extended perforated roll out shelves
- Top extensions shelves
- Directional locks
- Total locks
- Silicon door gasket for complete sterility control
- Door safety seal tab to ensure door close through transport

Custom sizes available upon request

Model	Case Dimension			OA Dimension			Adjustable Shelves	Card Holder
	Width	Depth	Height	Width	Depth	Height		
FHCMMCC1	26	24.25	47.25	31.75	28.375	56.375	2	1
FHCMMCC2	28.5	28.5	47.25	34.25	32.625	56.375	2	1
FHCMMCC3	40.25	24.25	30.25	46	28.375	39.375	1	1
FHCMMCC4	40.25	24.25	47.25	46	28.375	56.375	2	1
FHCMMCC5	36	25	47.25	41.75	29.125	56.375	2	1
FHCMMCC6	23.625	25	30.5	29.375	29.125	39.625	1	1
FHCMMCC7	35.5	24	44.5	41.25	28.125	53.625	2	1
FHCMMCC8	23	24.25	28.5	28.75	28.375	37.625	1	1
FHCMMCC9	23.625	25	46.25	29.375	29.125	55.375	2	1
FHCMMCC12	36	25	31	41.75	29.125	40	1	1
FHCMMCC14	46.5	25.25	31.25	52.25	29.375	40.25	2	1

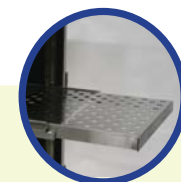
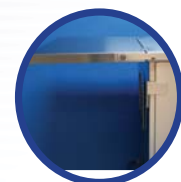

Surgical Case Carts

Open Case Carts:

- Overall size: 40.375"W x 28.625"D x 41.125" H
- Case dimensions: 36"W x 25"D x 30.125"H
- Open design
- Full wrap around non-marring bumper
- 1 stainless steel adjustable shelf w/ fixed stainless steel top and bottom
- Stainless steel guard rail
- Large 6" diameter, easy rolling, cart-washable casters with sealed bearings

Options:

- Wire grid on back side
- 8" casters
- Wire shelves
- Push handles



Custom sizes available upon request

Open Case Cart w/ Wire Shelves:

- Overall size: 60.375"W x 26.125"D x 67"H
- Heavily built distribution cart
- Perfect for storage, supplies, linen or distribution
- Full wrap around non-marring bumper
- 3 standard solid stainless steel adjustable shelves
- Large 6" diameter, easy rolling, cart-washable casters with sealed bearings

Options:

- Wire grid on back side
- 8" casters
- Wire shelves



Custom sizes available upon request

Medical Carts

- FHC offers a full line of medical, crash, anesthesia carts, cart packages, & cart accessories to ensure all your medical cart needs are met! Each of our cart packages & accessories are sold separately to allow customers to customize individual carts to their specific needs.

Medical Cart Features:

- Antimicrobial properties built in to protect portions of the product.
- Double wall construction
- Ball bearing slides with quick release
- Easy grip solid poly handles
- Stabilizer base w/ high impact, non-marking plastic bumper to add stability and keep cart from tipping
- 5" Premium easy roll casters (2 braking, 1 tracking, 1 swivel)
- ABS plastic top
- Premium latex-free powder coat paint
- Pre-threaded holes on side & back to easily mount accessories

Drawer Configurations: 3, 4, 5, or 6 drawers available for most carts. Pediatric carts available in 9 or 10 drawers.

Locking Options Available:

- Key lock
- Push button lock
- Lever/Breakaway lock
- Electronic lock
- Proximity lock



FXRL-433669-RED



FXGS-433669-ELB



W1

Medical Carts

Drawer Colors Available for Most Carts:



Available Cart Sizes:

ALUMINUM:



Elite Aluminum Unicarts:
29"W x 24.5"D
(includes stabilizer base)
Drawer interior dimensions:
22"W x 16.5"D

Elite Aluminum Med-Jr. Carts:
23"W x 24.5"D
(includes stabilizer base)
Drawer interior dimensions:
16.5"W x 16.5"D

STEEL:

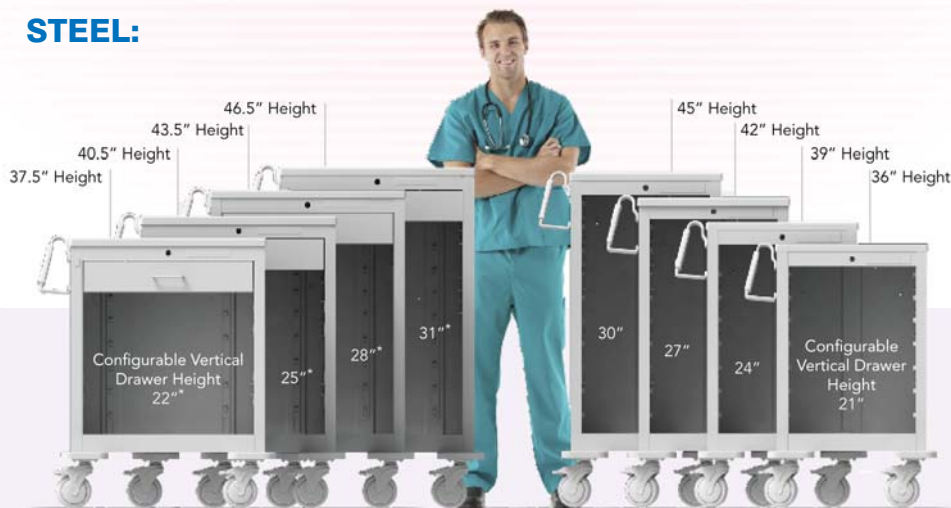

Steel Unicarts:
29"W x 24.5"D
(includes stabilizer base)
Drawer interior dimensions:
22"W x 16.5"D
*includes required 4" top drawer

Steel Med-Jr. Carts:
23"W x 24.5"D
(includes stabilizer base)
Drawer interior dimensions:
16.5"W x 16.5"D

Medical Carts

Anesthesia Carts:

FTGS-433369-DKB



Small, easy-to-clean & removable work surface.

Pre-drilled holes to mount accessories.

Advanced nylon reinforced poly carbonate bumper offers a wider wheel base for more stability while offering superior protection. Single piece construction that resists scuffs & scratches.

5" Premium "Easy-roll" sealed bearing casters with precision bearing swivels. Thread guards minimize sutures and other materials from collecting around axles and keep carts rolling smooth.

(Traditional Steel shown)

Isolation Carts:

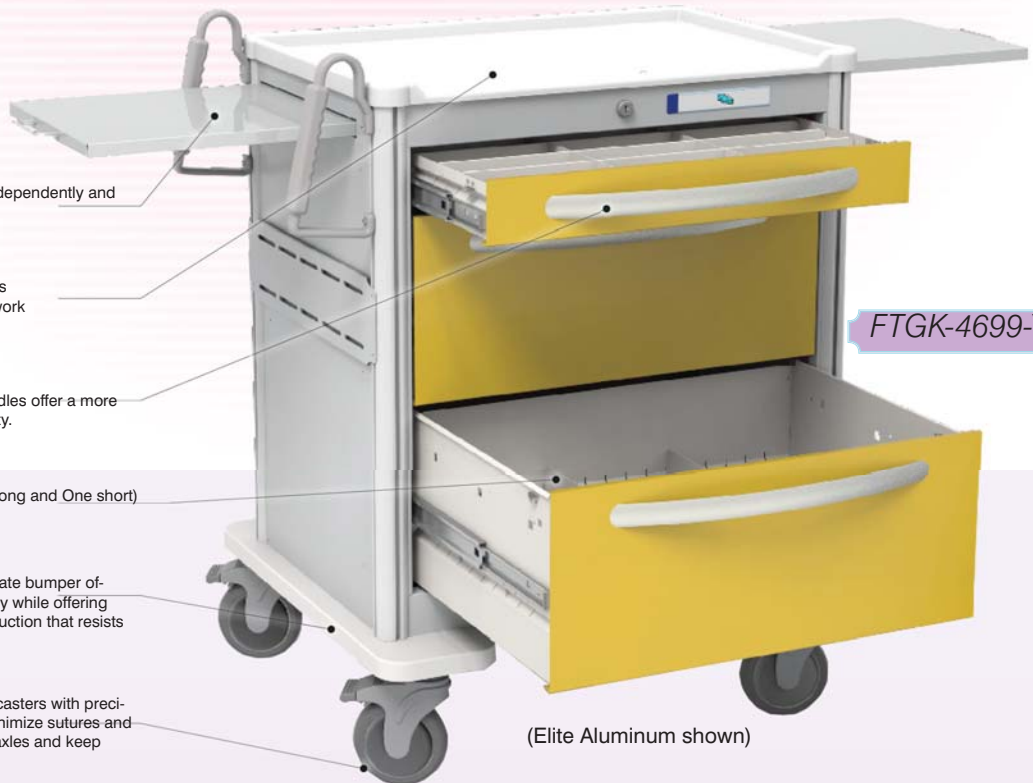

Dual slide out work surfaces operate independently and virtually double your work surface.

Included plastic top with cutaway front is designed to be "Wrist friendly" as you work on the cart top.

Large stylish/contemporary drawer handles offer a more updated look and enhanced functionality.

Adjustable metal drawer dividers (One long and One short) included in all aluminum cart drawers.

Advanced nylon reinforced poly carbonate bumper offers a wider wheel base for more stability while offering superior protection. Single piece construction that resists scuffs & scratches.

5" Premium "Easy-roll" sealed bearing casters with precision bearing swivels. Thread guards minimize sutures and other materials from collecting around axles and keep carts rolling smooth.

FTGK-4699-YEL

(Elite Aluminum shown)

Medical Carts

Emergency/Crash Carts:



(Elite Aluminum shown)

FTRLA-333369-RED



(Traditional Steel shown)

FXRL-433669-RED

Pediatric Emergency Carts:



(Elite Aluminum shown)

FTGLA-9PEDS-MULT



(Traditional Steel shown)

FTGL-9PEDS-MULT

Medical Carts

Hyperthermia Carts:



MPMMH-330-DB

The Steel Malignant Hyperthermia Cart helps with patient safety by providing a convenient way to store and transport refrigerated cold packs and saline solutions. The cart can store critical items needed with a 1.6 cubic feet refrigerator.



FXGKA-36F-DKB

This Aluminum Hyperthermia Cart Includes a SUMMIT 1.6 cu. ft. interior refrigerator with exterior digital thermostat and temperature alarm. The internal fan and gel packs help to stabilize the interior temperature. Key locking front door and hospital grade plug come standard.

Phlebotomy Carts:

This very popular cart offers a variety of storage compartments and tilt bins for all your phlebotomy supplies. But this cart is much more than for phlebotomy alone. With the built in tilt bins, waste receptacle and removable trays this cart can be used as an IV cart, Suture cart, etc...



FMSWA-34696-WHT

Medical Carts

Slim Med Junior Carts:

Consider our keyless locking options for Steel Med-Jr carts which include mechanical push-button, Electronic keypad and even Proximity card readers for swipe in/swipe out convenience! All carts available with a "Low profile" package that includes 3" casters mounted directly under the cart. (No Bumpers)



FJTGS-333369-SPG

Value Carts:

FHC value carts are designed with budget and size in mind. If you need a compact mobile storage solution that keeps an eye on your pocketbook then our Value cart is for you!

Standard Features:

- Centralized key lock.
- Ball bearing glide drawers.
- Removable ABS plastic top.
- 5" Premium easy roll casters (two braking, one steering, and one full swivel).
- Antimicrobial properties.



FESGK-399-LTG

Medication Carts:

Our full size cart offers half size drawers on the left for storage and supplies and space for up to 50 patient bins or full size drawers on the right. We also have a half size cart for use where space is limited. This cart can hold full size storage drawers, patient bins or a mix of both.



FMTK1-4B411/6TTTT

Medical Carts

Cross Reference Spec Chart:

CART FRAME DATA					DRAWER DATA				SECURITY	ANTI-MICROBIAL
FRAME STYLE	OVERALL DIMENSIONS	WEIGHT RANGE (lbs)	EXTERIOR COLORS	PULL-OUT SHELF	DRAWER INSIDE DIMENSIONS	DRAWER SIZES (inches high)	BUILT-IN DIVIDERS	DRAWER COLORS	LOCK OPTIONS	
ALUMINUM UNICART										
Short	36"h x 29"w x 24.5"d	65-90	LTG, RED, ELB	Yes	22"w x 16.5"d	3, 6, 9, 12	Yes	All 16 Options	Lever, Key, Pushbutton, Electronic, Proximity Card	Yes
Medium	39"h x 29"w x 24.5"d	70-95	LTG, RED, ELB	Yes	22"w x 16.5"d	3, 6, 9, 12	Yes	All 16 Options	Lever, Key, Pushbutton, Electronic, Proximity Card	Yes
Tall	42"h x 29"w x 24.5"d	75-95	LTG, RED, ELB	Yes	22"w x 16.5"d	3, 6, 9, 12	Yes	All 16 Options	Lever, Key, Pushbutton, Electronic, Proximity Card	Yes
X-Tall	45"h x 29"w x 24.5"d	80-100	LTG, RED, ELB	Yes	22"w x 16.5"d	3, 6, 9, 12	Yes	All 16 Options	Lever, Key, Pushbutton, Electronic, Proximity Card	Yes
STEEL UNICART										
Short	37.5"h x 29"w x 24.5"d	85-100	LTG, RED, ELB	No	22"w x 16.5"d	3, 4, 6, 9, 12, Panel	No	All 16 Options	Lever, Key, Pushbutton	Yes
Medium	40.5"h x 29"w x 24.5"d	85-100	LTG, RED, ELB	No	22"w x 16.5"d	3, 4, 6, 9, 12, Panel	No	All 16 Options	Lever, Key, Pushbutton	Yes
Tall	43.5"h x 29"w x 24.5"d	90-120	LTG, RED, ELB	No	22"w x 16.5"d	3, 4, 6, 9, 12, Panel	No	All 16 Options	Lever, Key, Pushbutton	Yes
X-Tall	46.5"h x 29"w x 24.5"d	100-140	LTG, RED, ELB	No	22"w x 16.5"d	3, 4, 6, 9, 12, Panel	No	All 16 Options	Lever, Key, Pushbutton	Yes
ALUMINUM BEDSIDE/MED JR.										
Short	36"h x 23"w x 24.5"d	60-80	LTG	Yes	16.5"w x 16.5"d	3, 6, 9, 12	Yes	All 16 Options	Lever, Key, Pushbutton, Electronic, Proximity Card	Yes
Medium	39"h x 23"w x 24.5"d	60-85	LTG	Yes	16.5"w x 16.5"d	3, 6, 9, 12	Yes	All 16 Options	Lever, Key, Pushbutton, Electronic, Proximity Card	Yes
Tall	42"h x 23"w x 24.5"d	65-85	LTG	Yes	16.5"w x 16.5"d	3, 6, 9, 12	Yes	All 16 Options	Lever, Key, Pushbutton, Electronic, Proximity Card	Yes
X-Tall	45"h x 23"w x 24.5"d	70-90	LTG	Yes	16.5"w x 16.5"d	3, 6, 9, 12	Yes	All 16 Options	Lever, Key, Pushbutton, Electronic, Proximity Card	Yes
STEEL BEDSIDE/MED JR.										
Short	36"h x 23"w x 24.5"d	80-95	LTG	No	16.5"w x 16.5"d	3, 6, 9, 12	No	All 16 Options	Lever, Key, Pushbutton, Electronic, Proximity Card	Yes
Medium	39"h x 23"w x 24.5"d	80-95	LTG	No	16.5"w x 16.5"d	3, 6, 9, 12	No	All 16 Options	Lever, Key, Pushbutton, Electronic, Proximity Card	Yes
Tall	42"h x 23"w x 24.5"d	85-115	LTG	No	16.5"w x 16.5"d	3, 6, 9, 12	No	All 16 Options	Lever, Key, Pushbutton, Electronic, Proximity Card	Yes
X-Tall	45"h x 23"w x 24.5"d	90-130	LTG	No	16.5"w x 16.5"d	3, 6, 9, 12	No	All 16 Options	Lever, Key, Pushbutton, Electronic, Proximity Card	Yes

Cart Size Options:

1. Choose a cart size (Short, Tall, X-Tall)
2. Select any combination of 3", 6", 9" or 12" drawers that fit within your cart's configurable drawer space.
3. Select drawer front colors based on color options below.

Build Your Part Number: (Ex: FTGKA-33669-RED)

Section 1 Letters:

- 1..."F" (for FHC cart)
- 2..."S" = Short, "M" = Medium, "T" = Tall, "X" = X-tall exterior
- 3..."B" = Blue, "G" = Lt. Gray, "R" = Red exterior ("W" = wood, for Tall exteriors only)
- 4..."K" = key, "L" = lever, "S" = simplex, "E" = electronic, "P" = proximity
- 5..."A" = aluminum (Traditional Steel if no 5th letter)

Section 2 Letters:

- 1...Height of 1st drawer
 - 2...Height of 2nd drawer
 - 3...Height of 3rd drawer
 - 4...Height of 4th drawer, etc.
- (Total for sec. 2 must = 21in. for short cart; 27in. for tall cart; 30in. for X-tall cart)

Section 3 Letters: (3 letters signify color choice for drawer fronts. See page 2 of carts for color choices)

*This Page
Intentionally
Left Blank*

Medical Cart Accessories

Drawer Accessories:



Clear Plastic Dividers

two per kit. Includes dividers. Fits in all drawers except half-sized Unicart or Medrx drawers.

FDIV-TRAY



Cut & Clip Divider System

Score the plastic strips and snap them to create your own divider system. Fits in all drawers. Set includes 22" long white plastic strips & 8 clips. FDIV-CC2 includes 2" H strips/FDIV-CC4 includes 4" H strips

**FDIV-CC2/FDIV-CC4
FDIV-CLIP**



2.5" Deep Configurable Gray Plastic Divider Tray

2.5" deep, includes dividers. Fits 2 per drawer, and typically used in 3" and 4" deep drawers. 9.25"W x 15"D x 2.5"H

FWDC-2025



4.75" Deep Configurable Gray Plastic Divider Tray

4.75" deep, includes dividers. Fits 2 per drawer, and typically used in 6", 9", and 12" deep drawers. 9.25"W x 15"D x 2.5"H

FWDC-2050



Adjustable Divider System w/ Large Divider Sections

Fits in 6", 9" and 12" deep full-sized Unicart drawers. 21.5"W x 15.25"D

FDIV-DRW5



Ampule Holder Divider System

With white plastic trays. Fits in all full-sized Unicart drawers. 21.5"W x 15.25"D x 2.3"H

FDIVTRAY-AMP



White Divider Box w/ Clear Lid

White plastic divider box with clear lid. Can be sealed with clear plastic seal.

21.75"W x 15.75"D x 2.5"H

FEMER-BOX



White Plastic Tray with Configured Bins

Can be easily reconfigured. Fits in all full-sized Unicart drawers.

22"W x 15"D x 2.5"H

FTT-1A



White Plastic Tray with Configured Bins

Can be easily reconfigured. Fits in all full-sized Unicart drawers.

22"W x 15"D x 2.5"H

FTT-1B

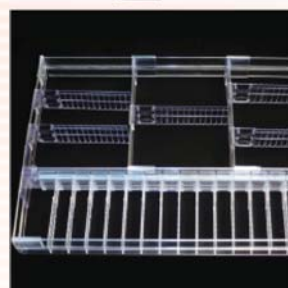

Adjustable Divider System w/ Row of Ampule Holders

21.5"W x 15.25"D

FDIV-DRW12



Adjustable Divider System w/ Large Divider Sections

21.5"W x 15.25"D

FDIV-DRW34

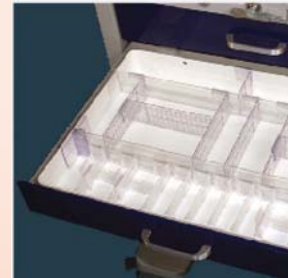

Ampule Holder Divider System

With white plastic trays. Fits in all full-sized Unicart drawers.

21.5"W x 15.25"D x 2.3"H

FDIVTRAY-ANES

Medical Cart Accessories

Drawer Accessories: (Continued)



Standard Divider System
With white plastic tray. Fits in all full-sized Unicart drawers.
21.5"W x 15.25"D x 2.3"H

FDIV-TRAY-STD
also available in 5" high version
FDIV-TRAY-STD5



Complete Ampule Holder Divider System
With white plastic tray. Includes 3 rows of 17 ampule dividers.
21.5"W x 15.25"D x 2.3"H

FWMT-3



Slim Med-Jr. Ampule Holder Divider System
Full drawer tray with 12 ampule dividers, ampule tray, rail and 4 adjustable dividers.
Fits 1 per drawer.
16"W x 16"D x 2.3"H

FWMT-4



Slim Med-Jr. Full Drawer Divider System
Full drawer tray with 2 rails and 4 adjustable dividers. Fits 1 per drawer.
16"W x 16"D x 2.3"H

FWMT-5



Divider Kit for 3" Aluminum Unicart Drawers
Includes 1 front-to-back and one side-to-side divider.

FDIV-AU3



Divider Kit for 6", 9", & 12" Aluminum Unicart Drawers
Includes 1 front-to-back and one side-to-side divider.

FDIV-AU6



Front & Back Divider System for Unicart Drawers
NOT for Med Jr. Drawers. Includes 3 front to back panels to create up to 4 compartments in one drawer.

FDIV-UC6 - For 6"H Drawers
FDIV-UC9 - For 9"H Drawers



Clear Dividable Trays
Trays fit in Unicart drawers and Instant Access Series.

FER-TRAY3
FER-TRAY6
For dividing systems, purchase **FDIV-DRW12ER**, **FDIV-DRW3ER** or **FDIV-DRW5ER**

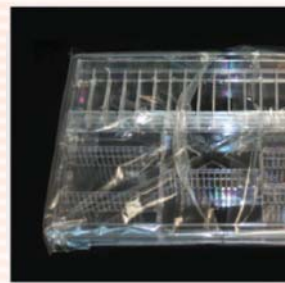

Sealable, Perforated Bags
Fits over divider trays. Package of 20.

FBAG-3
23"W x 17"D x 5.5"H
FBAG-6
23"W x 17"D x 7"H

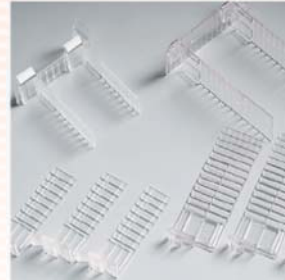

Long or Short, Clear Plastic Dividers
For use with **FDIV-DRW12**, **FDIV-DRW34**, **FDIVTRAY-STD**, **FDIVTRAY-AMP**, **FDIVTRAY-ANES**

FDIV-10L - Long dividers
FDIV-10S - Short dividers



Divider Kit for 3" Aluminum Med-Jr. Drawers
Includes 1 front-to-back and one side-to-side divider.

FDIV-AJ3



Divider Kit for 6", 9", & 12" Aluminum Med-Jr. Drawers
Includes 1 front-to-back and one side-to-side divider.

FDIV-AJ6

Medical Cart Accessories

Cart Accessories:



Lightweight Backside Cardiac Board Mount

Lightweight plastic cardiac board and metal mounting brackets for back side of Steel Unicart. Please see FCBB-7 for Aluminum Unicarts, FCBB-PC345 for FPC343 & FPC345. 24"W x 1"D x 18"H

FCBB-6



Lightweight Side Cardiac Board Mount

Lightweight plastic cardiac board and side mounting brackets for back side of Aluminum Unicarts or Med Jr. 24"W x 1"D x 18"H

FCBB-8



Thin Solid Plastic Cardiac Board Backside Mount

Thin solid plastic cardiac board and brackets for Steel or Aluminum Unicarts. 21"W x 15.25"D x 0.5"H

FCBB-9



FER2000 Backside Cardiac Board Mount

Lightweight plastic cardiac board mounting bracket and board for back side of the FER2000 cart.

FCBB-ER



Non-Locking Sharps Container Mounting Bracket

Mounts to side of all Unicarts, Med Jr, Medtrix, and DMC. Designed for 5 qt. container.

FSB-2



Utility Hooks

Mounts to existing holes on either side or back of cart. 2 hooks per package.

FUH-2



Oxygen Tank Mount

Plastic oxygen tank brackets with adjustable Velcro straps. For all Unicarts or Med Jr carts. For FPC343 or FPC345.

Please use part # FOTB-PC345.

FOTB-4



Metal Oxygen Tank Bracket

Can be mounted to all Unicarts and Med Jr carts.

FOTB-5



Sharp Container Mounting Bracket

With adjustable velcro strap. Mounts to side of all Unicarts, Med Jr, FER-2000, Medtrix, & DMC.

FSB-1



Locking Sharps Container Mounting Bracket

Mounts to side of all Unicarts, Med Jr, Medtrix, & DMC. Designed for 5 quart container.

FSB-2L



Self-Adhesive Chrome Hooks

Set of two self-adhesive chrome hooks that easily mount on any cart.

FABH-2



IV Pole

Chrome IV pole and mounting bracket. Mounts on Unicart, Med Jr, Medtrix, and DMC. For FER2000 please use part # FIV-3

FIV-2

Medical Cart Accessories

Cart Accessories: (Continued)



Coat Rack with Hooks
Made from lightweight aluminum. Mounts on Unicart, Med Jr, Medtrx, or DMC carts.

FCR-1



Side Mount Bucket Holder
Side mounting bucket holder and towel bar. Holds (2) 165oz cast buckets. 17.5"W x 6.5"D x 8.8"H

FCAST-1



Glove Box Holder
The NEW glove box holders are available in 3 sizes to fit any facilities' needs.

FBH-1 - one box (10"H x 4"D x 6"W)
FBH-2 - two box (10"H x 4"D x 12"W)



Small Waste Basket
Small (6 qt.) plastic waste basket. Requires accessory rail. 9"W x 6.25"D x 8.8"H

FBSK-1



Horizontal Glove Box Holder
Horizontal glove box holder. Holds 3 standard sized glove boxes.

FBH-3H



Large Waste Basket
Large (20 qt.) plastic waste basket. Requires accessory rail. 13"W x 8.5"D x 15"H

FBSK-2



Glove & Mask Glove Box Holder
Made from lightweight aluminum. Adjusts to many sizes of boxes. Mounts to railing on cart.

FGMH-1



Tilt Bins
Clear plastic tilt bins with white exterior. Available in 3,4,5, or 6 bin units. Mounts to base rail systems (FBRS-2, FBRS-3, or FBRS-JR)

FTB-3
FTB-4
FTB-5
FTB-6



Utility Receptacles
Available in 3 sizes. Requires accessory rail.

FUR-1 - .85 liters
FUR-2 - 1.5 liters
FUR-3 - 2.8 liters



Chart Holder
Gray steel chart holder. Mounts to accessory rail. 14.25"W x 1.75"D x 10"H

FCHT-1



Cylindrical Utility Receptacle
4" opening, 11" tall

FUR-4L



Notebook Mount
Wire notebook holder. Mounts to accessory railing. 12.5"W x 2.5"D x 10"H

FWNH-1

Medical Cart Accessories

Cart Accessories: (Continued)



Extra-Large Wire Basket
Mounts to accessory railing.
15.5"W x 9.5"D x 5.5"H

FWSB-1



Large Wire Basket
Mounts to accessory railing.
15.5"W x 5.5"D x 3.5"H

FWB-1L



Small Wire Basket
Mounts to accessory railing.
8.5"W x 5.5"D x 3.5"H

FWB-1S



Large Clear Plastic Organizer
Includes clear slide-in dividers. Mounts to accessory railing.
18"W x 5"D x 3"H

FORG-1L



Flat Shelf
Mounts to the horizontal rail system. (FBRS-2). Aluminum carts purchase FSHLF-3 & FBRS-3.
24"W x 10"D x 3/4"H

FSHLF-2



Two-Tier Shelving Unit
Mounts above Steel Unicarts. Order FSHLF-110A for aluminum carts.
26.5"W x 15.5"D x 1"H

FSHLF-110 - Steel
FSHLF-110A - Aluminum



Small Clear Plastic Organizer
Includes clear slide-in dividers. Mounts to accessory railing.
9"W x 5"D x 3"H

FORG-1S



Tape Dispenser
White tape dispenser with suction cups to attach to the top of a cart.

FTD-1



Horizontal Rail System
For hanging accessories and mounting shelves on Unicarts. Includes 2 vertical and 3 horizontal rails.

FBRS-2 - Steel or Aluminum carts
FBRS-JR - Med Jr. carts



Wrap-Around Aluminum Railing

May be used to hang accessories.

FR-3 - Steel carts
FR-4 - Aluminum carts
FR-JR - Med Jr. carts



Swiveling Monitor Shelf
Full swivel monitor shelf capable of locking in place. Includes adjustable strap to secure items in place. Max weight capacity 25 lbs. 13"W x 17"D x 12"H

FER-SHLF - Steel cart
FER-SHLFA - Aluminum cart
FER-SHLF2000 - Instant Access cart



Steel Scope Holder
Our durable steel scope holders secure easily to the wall or our Unicarts. Available in 2 sizes. Locking Plexiglas doors also included for added security.

FSH-2 - 2 scope holder
FSH-4 - 4 scope holder

Medical Cart Accessories

Cart Accessories: (Continued)



Collapsible Side Shelf

For Steel Unicart & Med Jr. Hangs on either side of cart. Surface area: 17.5"W x 15"D

FSSG-2C



Suction Shelf

For Unicart or Med Jr. Fits majority brands of suction units. 18" W x 8"D x 3"

FSS-M

Suction Pump

AC/DC portable unit provides 550mm HG and 50 lpm flow at the pump

FCEV3



Catheter Holder

Catheter holder for Unicart or Med Jr. 7.5"W x 2"D x 23"H

FCH-3



Backside Mounted Shelving System

This shelving unit includes (2) vertical rails, (1) top horizontal rail and (2) suture shelves. Aluminum carts require purchase of FAMP-2 for installation of this item.

Each shelf: 21.5"W x 5.5"D x 3.25"H

FSUT-1



Accessory Back Rail for Steel Med-Jr

Accessory rail for back attachment of accessories to the Steel Med Jr only.

FCB-2



Outlet Power Strip

Hospital grade outlet strip. 15 ft. long cord with 6 outlets.

FOS-1



Accessory Mounting Panel

For Lightweight Aluminum Unicarts. Mounts to SIDE to hold additional accessories.

FAMP-1



Accessory Mounting Panel

For Lightweight Aluminum Unicarts. Mounts to BACK to hold additional accessories.

FAMP-2



Accessory Side Rail

For Steel Unicarts or Steel Med-Jr carts. Rails for mounting various accessories to side of cart.

FSR-1



Accessory Back Rail

For Steel Unicarts or Steel Med-Jr carts. Rails for mounting various accessories to back of cart.

FCB-1



Cord Wrap

Usually used with outlet strip sold separately.

FCW-1



Fluid/Equipment Storage Tray System

For Steel, Med Jr or Medtrx/Halftr carts. Includes 2 trays. Each tray measures 17.52"W x 4.04"D x 4.5"H

FT-1 - Steel cart

FTA-1 - Aluminum cart

Medical Cart Accessories

Cart Accessories: (Continued)



Plastic Cart Cover

For Unicarts. Includes 5 bags.
Dimensions: 33" x 23" x 42"

FBAG-COVER5



Self-Adhesive Label Holders

1"H x 3"W, package of 100. Holders are loaded from the side.

FLH-1



Flexible Magnetic Light

For use on steel carts. Requires 2 AA batteries. Uses highly efficient LED bulb (included).

FLT-1



Locking Security Box

For use of transportation of narcotics or permanently mounted inside drawer. Includes 2 keys.
15.6"W x 11.4"D x 2.5"H

FSD-3



Deep Drawer Security Box

With security lid to secure medication in any full size Steel or Aluminum Unicart drawer 9"H. Includes lock w/ 2 keys.

FNARC-BOX



Proximity Lock Management Software

Management software for electronic and proximity locking systems.

FLOCKMANAGER

Proximity Card (pictured)

FPROX-1



Push-Button Locking Security Box

For use in transportation of narcotics. Permanently mounted. Includes override lock with 2 keys.

FSD-3S



Full Drawer Locking Security Box

Key locking, full drawer security box. Permanently mounted into drawer. Includes 2 keys. 21.5"W x 15.5"D x 2.5"H

FSD-3F



Aluminum Cart Gate Lock

For use on Lightweight aluminum carts. Can be used for securing narcotics and liquids or as a visible inventory management system. Available in Key-locking or Breakaway locking and in 3" increments up to 30" long.

FGLB -*Breakaway gatelock

FGLK -*Key gatelock

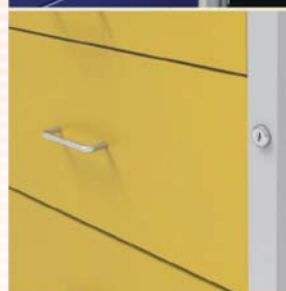

Steel Cart Gate Lock

For use on Steel carts. Available in Key-locking or Breakaway locking and in 3" increments up to 30" long.

FGLB -*Breakaway gatelock

FGLK -*Key gatelock

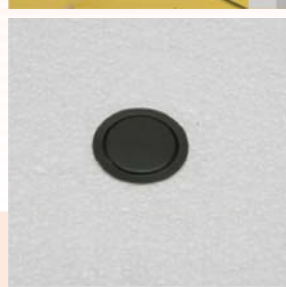

Self-Adhesive Proximity Tag

Small, adhesive proximity tag. 1" diameter

FPROX-2



Plastic Breakaway Seals

Can be used with lever locking systems, breakaway gate locks and FEMER-BOX divider trays.

FPS-100

Medical Cart Accessories

Example Cart Configurations:

FTRL-43336P-RED



FTGEA-333369-DKB



FTGK-433369-DKB-ANES-PKG



FTGLA-9PEDS-PKGA

Endoscopy Equipment

FHC Carrys a Full Line of state-of-the-art FSN Endoscopy Display Monitors.



FHC-STRYKER1188

**COMPLETE SYSTEM
READY TO SHIP!**



FS-L2701DT

FHC carries a full line of FSN medical-grade display monitors, ranging in size from 19" to 55". Each display comes with an extensive list of input and output connections and touchscreen option. FSN's highly integrated design approach takes into consideration the multitude of video formats that are in use today. FSN's medical video solutions are engineered for compatibility with other highly specialized surgical and diagnostic equipment used in surgical suites, operating rooms, emergency rooms, and procedural facilities.

Endoscopy Equipment

We also offer choice refurbished Endoscopy Systems set-up & ready to ship!

50-Watt LED Light Source:

- 50-watt LED light source
- More than 50,000 hours LED array life
- 6500°K color temperature
- Turret ports (Storz, ACMI, Olympus, Wolf)
- Manual variable light intensity control
- Dimensions: 7.6" x 5" x 7.75"

Also available: BR900-2460 - 100-Watt LED Light Source



BR900-2453

180-Watt Xenon Light Source:

- 180-watt Xenon arc
- Average of 650 hours prorated lamp life
- 5600°K color temperature
- Turret ports (Storz, ACMI, Olympus, Wolf)
- Manual variable light intensity control
- Dimensions: 14" x 4.75" x 13.4"

Also available: BR900-2301 - 300-watt LED Light Source



BR900-2181

150-Watt Halogen Light Source:

- 150-watt Halogen
- 3600°K color temperature
- Single ports (Storz), other adapters available
- Manual variable light intensity control
- Dimensions: 7" x 3.25" x 8"

Also available: BR900-2252HLS - 250-watt Dual Lamp Halogen Light Source



BR900-2150HLS

Xenon, LED/Halogen, and Wireless LED Headlamps Also Available!

Endoscopy Equipment

Control OR Video Integration System:

- Simultaneous distribution of signal sources to one or more displays
- Input/output connections using analog, digital, and fiber standards
- Picture-in-picture, picture-by-picture, and picture-on-picture capabilities
- Configure video distribution via touch screen tablet interface
- Upgrades and maintains signal integrity
- Small footprint - resides on cart or boom shelf, next to video sources



FS-IPS1000A

Wireless Transmitter & Receiver:

- Wireless HD video without compression
- Signal is encrypted and bonds 1-to-1
- Range is designed to stay within one room
- FDA 510k clearance
- Near zero latency
- 60 Ghz reliability
- Mounts easily to a variety of surfaces
- Transmitter and receiver automatically synchronize
- Supports high quality 1080p video
- Multiple transmitter and receivers can be configured to form a network



FS-WIS1000

Signal Conditioner:

- Scales a video signal, up or down, for optimum wireless transmission
- Mounts as a base to FS-WIS1000 wireless transceivers
- Supports high quality 1080p video
- Optional VESA mount bracket



FS-WIS1001

Endoscopy Equipment

19" FSN Medical LCD Display Monitor:

- Rapid signal detection, robust mode tables
- High-bright LED backlight
- Fanless - sterile field compatible
- Built to last, rugged aluminum housing
- Calibrated to clinical color
- DVI & SDI connections
- Image pan, zoom, freeze, picture-in-picture



FS-Y1901D

24" FSN Medical LCD Display Monitor:

- Rapid signal detection, robust mode tables
- High-bright LED backlight
- 2 DVI in/out
- 5v DC power output
- Fanless - sterile field compatible
- Built to last, rugged aluminum housing
- Optical enhancement
- Calibrated to clinical color
- Image pan, zoom, freeze, picture-in-picture



FS-L2402D

26" FSN Medical LCD Display Monitor:

- Rapid signal detection, robust mode tables
- High-bright LED backlight
- Touch option
- Artifact-free HD images
- Enhancement option
- Fanless - sterile field compatible
- Built to last, rugged aluminum housing
- Calibrated to clinical color
- Image pan, zoom, freeze, picture-in-picture



FS-P2601D

Endoscopy Equipment

26" FSN Medical Enhanced LCD Display Monitor:

- Improved contrast ratio and brightness
- Humidity and breakage resistant
- Rapid signal detection, robust mode tables
- Artifact-free HD images
- High-bright LED backlight
- Fanless - sterile field compatible
- Built to last, rugged aluminum housing
- Calibrated to clinical color
- Image pan, zoom, freeze, picture-in-picture



FS-P2602D

26" FSN Medical Expanded LCD Display Monitor:

- Rapid signal detection, robust mode tables
- High-bright LED backlight
- Expanded input/output options
- Artifact-free HD images
- 2 DVI in/out, 2 3G-SDI in/out
- Fanless - sterile field compatible
- Calibrated to clinical color
- Polymer housing
- Image pan, zoom, freeze, picture-in-picture

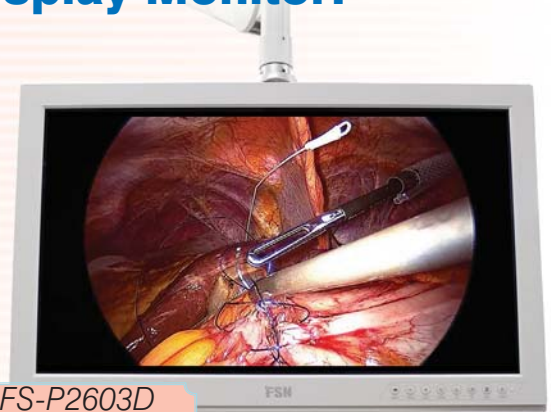

FS-P2603D

27" FSN Medical LCD Touch LCD Display Monitor:

- Touch-screen display
- Rapid signal detection, robust mode tables
- High-bright LED backlight
- Artifact-free HD images
- Fanless - sterile field compatible
- Built to last, rugged aluminum housing
- Flush surface
- Lightweight of only 18 lbs.
- 1 SD/HD/3G-SDI in/out
- 2 DVI in, 1 DVI out
- Image pan, zoom, freeze, picture-in-picture



FS-L2701DT

Endoscopy Equipment

32" FSN Medical LCD Display Monitor:

- Rapid signal detection, robust mode tables
- High-bright LED backlight
- Artifact-free HD images
- Fanless - sterile field compatible
- Built to last, rugged aluminum housing
- Calibrated to clinical color
- 2 DVI in/out
- 5v DC power output
- 2 3G-SDI in/out
- Image pan, zoom, freeze, picture-in-picture

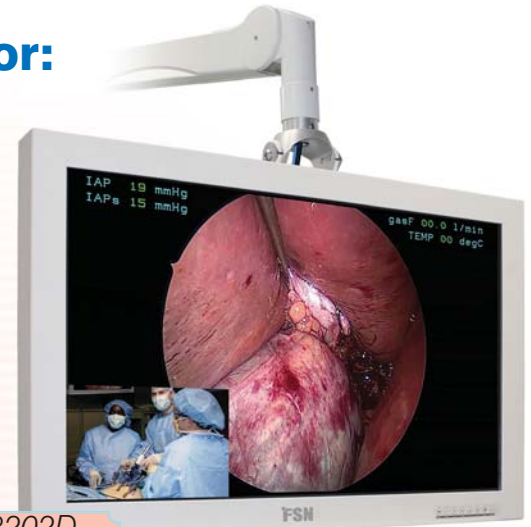

FS-L3202D

46" FSN Medical LCD Touch Display Monitor:

- Large touch-screen display
- Rapid signal detection, robust mode tables
- High-bright LED backlight
- Artifact-free HD images
- Fanless - sterile field compatible
- Built to last, rugged aluminum housing
- Flush surface
- 1 DVI-D and 1 SD/HD/3G-SDI in/out
- image pan, zoom, freeze, picture-in-picture

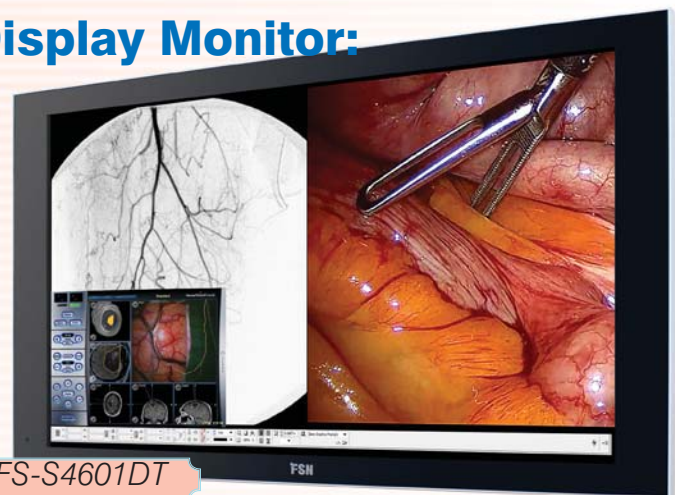

FS-S4601DT

55" FSN Medical LCD Display Monitor:

- Rapid signal detection, robust mode tables
- High-bright LED backlight
- Fanless - sterile field compatible
- Ultimate large-screen display
- Built to last, rugged aluminum housing
- Calibrated to clinical color
- DVI & SDI connections
- Internal power supply
- Image pan, zoom, freeze, picture-in-picture

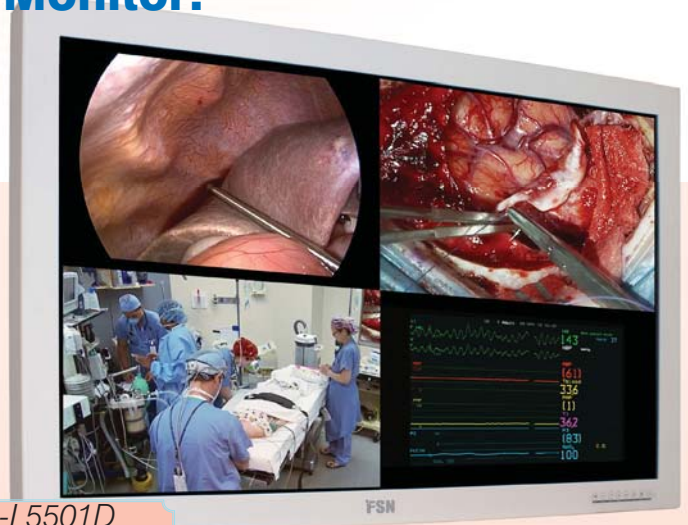

FS-L5501D

Electrosurgical Units

We offer quality new & refurbished ESU's from the best manufacturers of today.



AAA1250

Bovie Aaron 1250 ESU Features:

- Cut, Blend, Coagulation, Fulguration, and Bipolar modes
- Automatic safety features: self-test circuits, audible tones, discreet outputs, isolated circuitry and Bovie NEM™
- 120 watts cutting power
- Both monopolar and bipolar functions
- 90 watts blended (80 watts max power) and fulguration (40 watts max power)
- Two levels of coagulation: pinpoint and fulguration
- Large illuminated digital displays

Bovie Aaron 2250 ESU Features:

- 10 blend settings & 1 cut mode
- Monopolar & bipolar functions
- 10 blend modes
- 200 watts maximum power
- Digital error detection
- BovieFDFS™ (Fast Digital Feedback System)
- 2 levels of coagulation:
 - Coagulation (120 watts max power)
 - Fulguration (80 watts max power)



AAA2250

Bovie Aaron 3250 ESU Features:

- 10 blend settings
- Monopolar & bipolar functions
- 10 blend modes
- 2 cut modes
- 300 watts maximum power
- Highest level of quality and safety
- Cost-efficient
- Digital error detection
- 10 presets for common settings
- BovieFDFS™ (Fast Digital Feedback System)
- 2 levels of coagulation:
 - Coagulation (120 watts max power)
 - Bipolar (80 watts max power)
 - Fulguration (80 watts max power)



AAA3250



AAA812

**Don't forget to ask your sales rep
about our ESU Mobile Stands!**



Electrosurgical Units



FHC-VALLEYLABFX

ValleyLab FX ElectroSurgical Unit

- **Dimensions:** 4.375" H x 14" W x 17" L
- **Weight:** 18 lbs.
- **Input Power Requirements:**
 - Operating Range: 170 - 264 VAC
 - Max Current: 3.5 A in cut and 2 A in coag
- **Output Waveforms: Bipolar:**
 - Precise, standard & Macros: 470 kHz sinusoid
- **Monopolar Cut:**
 - Low: 390 kHz sinusoid similar to pure cut mode except max voltage limited to a lower value. Pure 390 kHz sinusoid
 - Blend: 390 kHz bursts of sinusoid, recurring at 27 kHz intervals, 50% duty cycle envelope.
- **Monopolar Coag:**
 - Desiccate: 240 kHz sinusoid repeated at 39 kHz, 8% duty cycle
 - Fulgurate: 390 kHz damped sinusoidal bursts with a repetition frequency of 57 kHz into 300 Ohm
 - Spray: 390 kHz damped sinusoid bursts w/ randomized repetition centered at 28 kHz
 - Frequencies include 21 kHz < f < 35 kHz
- **Low Frequency Leakage:** 50 - 60 Hz
- **High Frequency Leakage:**
 - Bipolar: < 59.2 mArms
 - Monopolar: < 150 mArms
 - CEM™: < 150 mArms at < or equal 50 W

ValleyLab Force 2 Electro Surgical Unit

- **Dimensions:** 8"H x 13"W x 21"L
- **Weight:** 23 lbs.
- **Input Power Requirements:**
 - Operating Range: 85 - 135 VAC
- **Output Waveforms:**
 - Cut:** 510 kHz sinusoid
 - Blend 1:** 510 kHz sinusoidal bursts at 50% duty
 - Blend 2:** 510 kHz sinusoidal bursts at 37.5% duty cycle recurring at 31 kHz
 - Blend 3:** 510 kHz sinusoidal bursts at 25% duty cycle recurring at 31 kHz
 - Low Voltage Coag:** 510 kHz sinusoidal bursts at 25% duty cycle recurring at 31 kHz
 - Bipolar:** 510 kHz
- **Low Frequency Leakage:** 50 - 60 Hz
- **High Frequency Leakage:** Less than 150 mArms



FHC-VALLEYLAB2

Footstools

EZ Stacking Interlocking Step Stool:

- Dimensions: 12"D x 18"W x 5"H
- Slip proof rubber tread surface
- Tip resistant
- Stools can interlock to form desired size platform
- Stools are stackable for increased height and storage
- Fully welded stainless steel construction



Optional:



Stacking Stool Carry Cart

- 16 gauge stainless steel
- Fully welded construction
- Provides storage/transportation for stacking stools as an all-in-one- solution
- 3" scuff-resistant casters
- Designed to carry 4 stools
- Reinforced handle

Chrome Rigid Footstool

- Dimensions: 11 3/8"D x 14 1/4"W x 9 1/2"H
- Triple chrome plated steel
- All welded steel construction
- 17 weld points on each stool
- Non-slip black rubber mat
- Metal washers inside rubber tips to protect flooring surfaces



Chrome Rigid Footstool with Handle

1251



- Dimensions: 11 3/8"D x 14 1/4"W x 9"H
- Measures 35 3/4" from top of rail to floor
- Triple chrome plated steel
- All welded steel construction
- 17 weld points on each stool
- Non-slip black rubber mat
- Metal washers inside rubber tips to protect flooring surfaces

S/S Tables

Instrument & Back Tables:

Not only are our instrument tables made from the highest quality stainless steel available, they are also manufactured to cater to all of your specific space requirements to fit your facility's needs.

Standard Features:

- Fully-welded construction
- Reinforced tops
- Durable 1 1/4" 16 gauge stainless steel legs
- 16 gauge type 304 stainless steel top
- 18 gauge type 304 stainless steel under shelf
- 2" swivel casters

Options:

- 3" swivel casters
- Locking casters
- Drawers under all sizes
- Stainless steel guard rails
- H or U brace instead of under shelf
- Nesting sets
- Multiple under shelves

Standard Models:

Model #	Width	Depth	Height
FHC8018	16	20	34
FHC8016	16	30	34
FHC8010	24	36	34
FHC8008	24	48	34
FHC8004	24	60	34
FHC8000	24	72	34



Custom sizes available upon request

S/S Tables

Example Table Configurations:



FHC8016

Table with H-Brace



FHC8004

Table with Under Shelf



FHC8000

Table with U-Brace

Sterile Process/Work Tables:

Standard Features:

- Fully-welded construction
- Sound-proofed reinforced tops
- Durable 1 1/4" to 1 5/8" 16 gauge type 304 stainless steel legs
- 16 gauge type 304 stainless steel top
- 18 gauge type 304 stainless steel under shelf
- 5" swivel casters



Nesting Tables

Options:

- Hydraulic adjustable heights for ergonomics
- Locking casters
- Full base unit underneath
- Drawers under all sizes
- Stainless steel guard rails
- H or U brace instead of under shelf
- Nesting sets
- Multiple under shelves

Custom sizes available upon request



Work Table

S/S Tables

Utility Tables/Prep Stands:

Standard Features:

- Fully-welded construction
- Reinforced tops
- Durable 1 1/4" 16 gauge stainless steel legs
- 16 gauge type 304 stainless steel top
- 18 gauge type 304 stainless steel under shelf
- 2" swivel casters

Options:

- 3" swivel casters
- Locking casters
- Drawers under all sizes
- Stainless steel guard rails
- H or U brace instead of under shelf
- Nesting sets
- Multiple under shelves



Available in 4 models: single, double, triple, & four drawers
Size: 16"D x 20"W x 34"H

Custom sizes available upon request



(Models shown with optional locking casters)

AB3

S/S Tables

Space Saver Instrument Tables:

Standard Features:

- Main table size: 30"D x 60"W x 34"H
- Top shelf size: 20"D x 60"W
- Used for large instrument/equipment intensive cases
- Top cantilevered shelf holds multiple trays & angled for easy view of instruments
- Shelf is easily raised when extra space is required or lowered into its storage position if not in use
- Crank handle enables one-person operation
- S/S 4" casters, 2 w/ brakes & 2 non-locking
- Round or square leg options available
- 2" swivel casters

Custom sizes available upon request



Sample Space Saver Drawing:

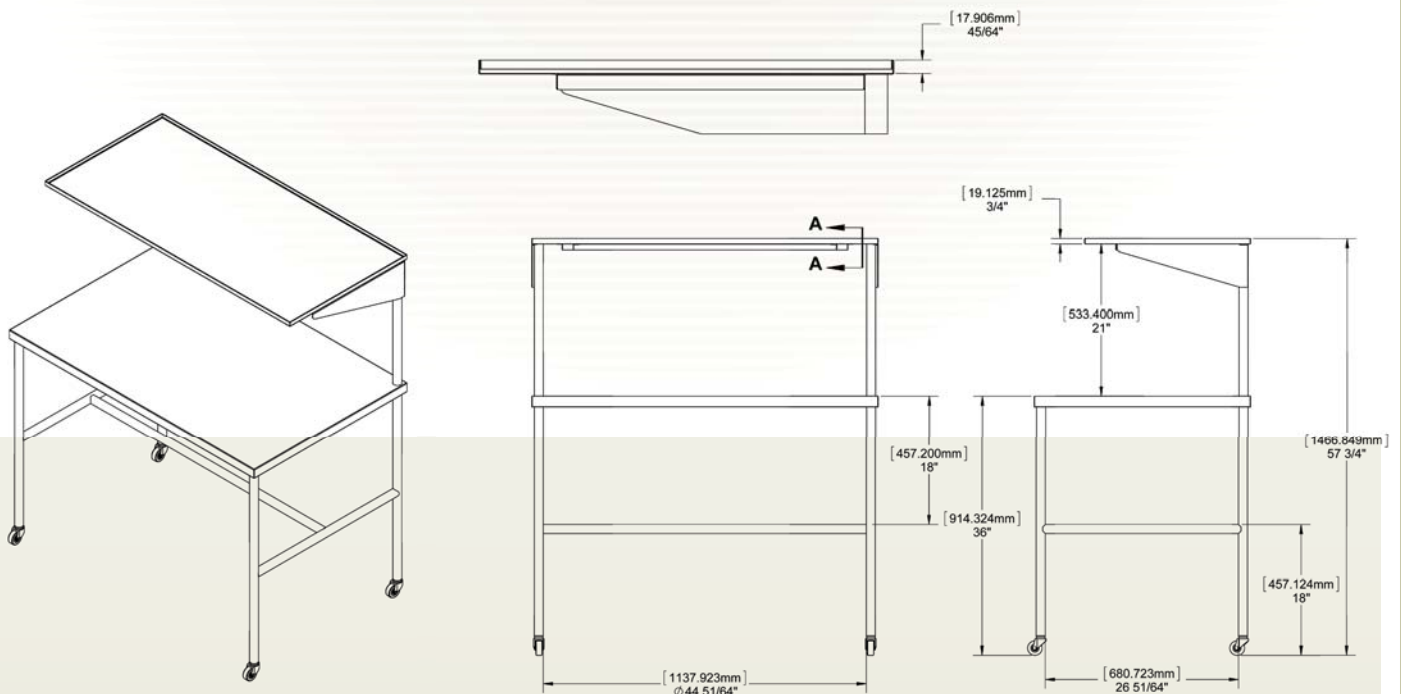

AB4

IV Stands

Constructed with fully welded stainless steel and tip-resistant base, the FHC IV stands are built with durability and reliability in mind. The FHC1315 and FHC1415 series IV poles give customers the option between hand or foot operated adjustment, and the number of hooks to be included.

FHC1315 Series Standard Features:

- Fully welded stainless steel construction
- 2" swivel casters
- Tip resistant base
- 68" - 108" height adjustment
- Hand operated
- Five leg stand

FHC1315-2 - 2 hook design

FHC1315-4 - 4 hook design

FHC1315-6 - 6 hook design

FHC1415 Series Standard Features:

- Fully welded stainless steel construction
- 2" swivel casters
- Tip resistant base
- 68" - 108" height adjustment
- Foot operated
- Five leg stand

FHC1415-2 - 2 hook design

FHC1415-4 - 4 hook design

FHC1415-6 - 6 hook design

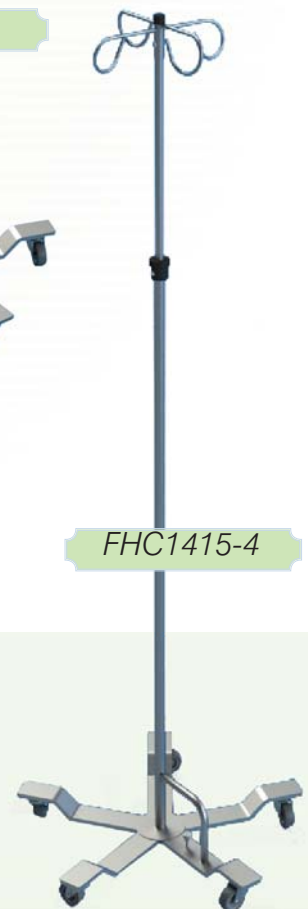
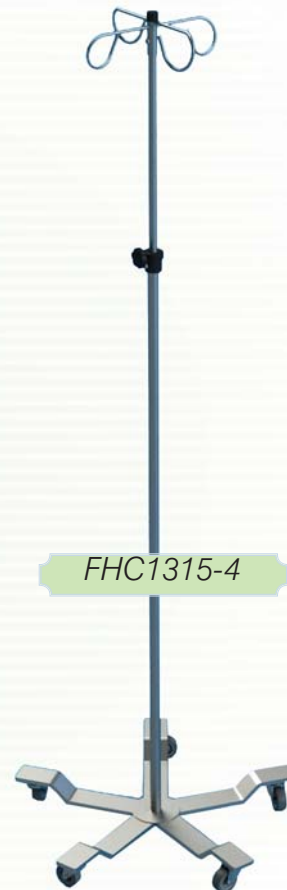

FHC1410 Series Standard Features:

- 2" swivel casters
- Tip resistant base
- 68" - 108" height adjustment
- Hand operated
- Four leg stand
- Knocked-down design for low-cost shipping

FHC1410-2 - 2 hook design

FHC1410-4 - 4 hook design

FHC1410-6 - 6 hook design



FHC1510 Series Standard Features:

- 2" swivel casters
- Tip resistant base
- 68" - 108" height adjustment
- Hand operated
- Five leg stand
- Knocked-down design for low-cost shipping

FHC1510-2 - 2 hook design

FHC1510-4 - 4 hook design

FHC1510-6 - 6 hook design



Also available: FHC1610 IV stand:

- Six-leg stand

IV Stands

Stainless Steel Lift Assist IV Pole Standard Features:

- Eliminates back injuries
- Easily lifts heavy loads by simply turning the crank
- Height adjustable from 56" - 96" high
- 6 leg base offers supreme stability
- 3" scuff resistant casters provide unmatched maneuverability
- 2" square stainless steel tube base post
- 1 1/4" stainless steel extension post tube
- No electric motors or hydraulic pumps to be concerned about or replace
- Many accessories optional available (universal clamp, infusion pump frame, add-a-tray)

FHC251 - 4 hook design

FHC252 - 8 hook design

FHC253 - 28 hook design



Shown with optional:
FHC260 - add-a-tray
FHC259 - infusion pump frame
FHC257 - universal clamps

AC3

Stainless Steel 5-Leg Infusion Pump Stand Standard Features:

- 16" diameter space saving base decreases obstruction in the operating room
- Base weight of 21 pounds for unmatched stability
- 3" scuff resistant casters
- Stainless steel pole section & detachable top
- Height adjustable from 52" - 94"
- Soft touch friction knob
- Standard base color is charcoal
- Optional base colors available upon request: (Red, Green, Yellow, Blue)

FHC221 - 2 hook design

FHC222 - 4 hook design

FHC223 - 6 hook design



Infusion Pump Stand Color Options:



Solution Stands



FHC Single Basin Ring Stand

- Fully-welded stainless steel construction
- Overall size: 14"D x 14"W x 34"H
- Removable 7 quart stainless steel basin
- 2" casters cap swivel
- Accessible from any side with open frame design

FHC7809HB - optional 8 1/2 quart basin

FHC7808HB

FHC Single Basin Ring Stand w/ Shelf

- Fully-welded stainless steel construction
- Overall size: 14"D x 14"W x 34"H
- Removable 7 quart stainless steel basin
- Stainless steel lower shelf
- 2" casters cap swivel
- Accessible from any side with open frame design

FHC7809SS - optional 8 1/2 quart basin



FHC7807SS

Solution Stands



FHC7808HB

FHC Double Basin Ring Stand

- Fully-welded stainless steel construction
- Overall size: 14"D x 28"W x 34"H
- Two removable 7 quart stainless steel basins
- 2" casters cap swivel
- Accessible from any side with open frame design

FHC7808HB - optional 8 1/2 quart basin

FHC Double Basin Ring Stand w/ Shelf

- Fully-welded stainless steel construction
- Overall size: 14"D x 28"W x 34"H
- Two removable 7 quart stainless steel basins
- Stainless steel lower shelf
- 2" casters cap swivel
- Accessible from any side with open frame design

FHC7810SS - optional 8 1/2 quart basin



FHC7808SS

Linen Hampers

FHC Triangular Linen Hamper:

- Fits 18" bags
- Fully welded, heavy gauge stainless steel construction
- 3" double ball bearing, swivel casters
- Full, heavy gauge stainless steel platform supports bags & ease of removal
- Overall size: 35"H x 57 1/4" perimeter
- Accommodates 18" diameter bags
- Available with foot control (FHC2301SS-FC)

Options:

- Foot operated stainless steel lid
- Rotating bumper guards over casters



FHC Large Triangular Linen Hamper:

- Fits 25" bags
- Fully welded, heavy gauge stainless steel construction
- 3" double ball bearing, swivel casters
- Full, heavy gauge stainless steel platform supports bags & ease of removal
- Overall size: 35"H x 78 5/8" perimeter
- Accommodates 25" diameter bags
- Available with foot control (FHC2302SS-FC)

Options:

- Foot operated stainless steel lid
- Rotating bumper guards over casters



Chrome Step-On Hamper w/ Lid:

- Lid dimensions: 18.63"W x 19.5"D
- Hamper height: 37.75"H
- White, polycoated steel lid
- Non-slip foot pedal
- Lid-locking ability for open position
- Supports 36 - 42 gallon bags (not included)
- Metal ring to keep bags in place
- Hamper bag storage pouch
- 3" hard wheel casters (2 locking)



Linen Hampers

FHC Circular Linen Hamper:

- Fits 18" bags
- Fully welded, heavy gauge stainless steel construction
- 3" double ball bearing, swivel casters
- Full, heavy gauge stainless steel platform to support bags & ease of removal
- Overall size: 35"H x 18" diameter
- Accommodates 18" diameter bags
- Available with foot control (FHC2201SS-FC)

Options:

- Foot operated stainless steel lid
- Rotating bumper guards over casters



FHC Large Circular Linen Hamper:

- Fits 25" bags
- Fully welded, heavy gauge stainless steel construction
- 3" double ball bearing, swivel casters
- Full, heavy gauge stainless steel platform to support bags & ease of removal
- Overall size: 35"H x 25" diameter
- Accommodates 25" diameter bags
- Available with foot control (FHC2202SS-FC)

Options:

- Foot operated stainless steel lid
- Rotating bumper guards over casters



Mayo Stands



FHC8669SS

FHC Manual Single Post Mayo Stand:

- Fully-welded stainless steel construction
- Single-post design
- Removable 21 1/4" x 16 1/4" stainless steel tray
- Manual knob operated adjustment/single post
- 2" casters

FHC8667SS - same as above, except with 19 1/8" x 12 5/8" stainless steel tray

FHC Hand Operated Single Post Mayo Stand:

- Fully-welded stainless steel construction
- Single-post design
- Removable 21 1/4" x 16 1/4" stainless steel tray
- Hand operated friction lock height adjustment/single post
- 2" casters

FHC8967SS - same as above, except with 19 1/8" x 12 5/8" stainless steel tray



FHC8969SS



FHC8868SS

FHC Foot Operated Single Post Mayo Stand:

- Fully-welded stainless steel construction
- Single-post design
- Removable 21 1/4" x 16 1/4" stainless steel tray
- Foot operated friction lock height adjustment/single post
- 2" casters

FHC8866SS - same as above, except with 19 1/8" x 12 5/8" stainless steel tray

Mayo Stands

FHC Foot Operated Dual Post Mayo Stand:

- Fully-welded stainless steel construction
- Double-post design
- Removable 21 1/4" x 16 1/4" stainless steel tray
- Foot operated friction lock height adjustment/dual post
- 2" casters

FHC8867SS - same as above, except with 19 1/8" x 12 5/8" stainless steel tray

FHC8871SS - same as above, except with 25" x 20" stainless steel tray



FHC Hand Operated Dual Post Mayo Stand:

- Fully-welded stainless steel construction
- Double-post design
- Removable 21 1/4" x 16 1/4" stainless steel tray
- Hand operated friction lock height adjustment/dual post
- 2" casters

FHC8767SS - same as above, except with 19 1/8" x 12 5/8" stainless steel tray

FHC8771SS - same as above, except with 25" x 20" stainless steel tray

Optional: Mobile Base (-MB)



Kick Buckets

FHC7768SS Standard Features:

- Overall size: 8"H x 16 1/4" diameter
- Removable 8 1/2 quart stainless steel basin
- Stainless steel frame
- Perimeter bumper to protect walls
- 2" swivel casters
- Tip resistant



FHC7766SS Standard Features:

- Overall size: 14"H x 13 1/2" diameter
- Removable 12 quart stainless steel basin
- Stainless steel frame
- Perimeter bumper to protect walls
- 2" swivel casters
- Tip resistant



*This Page
Intentionally
Left Blank*

S/S Lab/Surgical Products

Solution Pails

- Tapered for easy pouring
- Ears for handles are break-off resistant
- Designed for easy cleaning



PO12N



PO88

Storage Containers & Covers

- Variety of containers and covers available

Lab/Utility Scoops

- Heavy duty
- Seamless body
- Strong, tubular handle for easy handling and cleaning

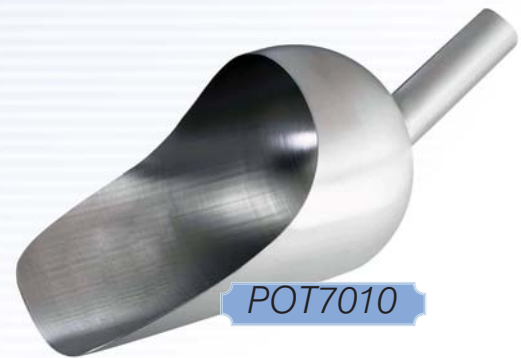

POT7010



PO6G

PO14G

Iodine/Oil Cups

- Variety of containers and covers available
- Stainless steel cups

S/S Lab/Surgical Products

Instrument Trays with Covers

- Heavy duty and seamless
- Coved corners for easy sterilization
- Recessed strap handles
- Available without covers and slight flange



Catheter Trays & Dome Covers

- Heavy duty and seamless
- Dome covers w/ strap handles
- Covers sold separately



Sterilization Trays/Bath Sets

- Used for hot or cold sterilization
- Recessed strap handle



Oblong Instrument/Drying Trays

- Covered corners
- Large, open bead for easy handling, stacking, and cleaning



S/S Lab/Surgical Products

Perforated Instrument Trays

- Heavy duty stainless steel
- Corrosion-resistant surface
- Rounded tray edges



Thermometer/Forcep Jars

- Heavyweight base to prevent tipping



Solution Basins

- Easy-to-clean large rounded radius corners
- No spin recessed bottom for stability



Emesis Basins

- Easy-to-clean, seamless design



S/S Lab/Surgical Products

Sponge Bowls

- Wide mouth
- Flat bottom and straight sides



O.R. & Procedure Bowl

- Containing/Identifying solutions
- Wide flange



Dressing Jars w/ Slip-Over Covers

- Easy-to-clean, seamless design
- Recessed lid handles



Medicine Cup - Graduated

- Stainless steel cup
- 2oz. graduated



S/S Lab/Surgical Products



POT1064

Graduated Measure

- Graduated in ounces and cc's
- Measures have easy grip handles
- Large, smooth pouring spouts

Ointment/Applicator Jars

- Stainless steel jars
- Applicator jar has 28 oz. capacity
- Ointment jar has 9 oz. capacity
- Applicator jar dimensions: 3 1/8"H x 7"H w/ strap handle cover
- Ointment jar dimensions: 3 1/8"H x 2 3/4"H w/ strap handle cover

PO257

PO25



Not enough? We can supply all the essentials for your lab/surgical supplies. Ask your sales rep to see our full line of sizes and products!

*This Page
Intentionally
Left Blank*

Medical Seating

993 Exam Stool: 360° Hand Ring Adjustment

Standard Features:

- Polished aluminum base
- Standard height adjustment: 17" – 22"
- Seat diameter: 16"
- Base diameter: 24"
- California 117 fire resistant foam
- 3/4" thick composite substrate with steel reinforcement plate
- Weight capacity: 300 lbs.
- COM requirement 1 yd

Options:

- Back rest (Order Ex. IN993-B)
- 18" polished chrome foot rest (Order ex. IN993-F)
- 7" stroke cylinder: 19" - 26" (Order ex. IN993-7)
- 10" stroke cylinder: 23" - 33" (Order ex. IN993-10)
- Soft wheel casters or glides (Please specify)



983 Exam Stool: 360° Foot Ring Adjustment

Standard Features:

- Polished aluminum base
- Standard height adjustment: 19" to 24"
- Seat diameter: 16"
- Base diameter: 24"
- Overall height with backrest: 33" to 38"
- Pneumatic height adjustment
- COM requirement 1 yd
- Weight capacity: 300 lbs.

Options:

- Back rest (Order ex. IN983-B)
- 7" stroke cylinder: 19" - 26" (Order ex. IN983-7)
- 10" stroke cylinder: 23" - 33" (Order ex. IN983-10)
- Soft wheel casters or glides (Please specify)



973 Exam Stool: D-Handle Release

Standard Features:

- Polished aluminum base
- Standard height adjustment: 17" – 22"
- Seat diameter: 16"
- Base diameter 24"
- California 117 fire resistant foam
- 3/4" thick composite substrate with steel reinforcement plate
- Weight capacity: 300 lbs.
- COM requirement 1 yd

Options:

- Back rest (Order ex. IN973-B)
- 18" polished chrome foot rest (Order ex. IN973-F)
- 7" stroke cylinder: 19" - 26" (Order ex. IN973-7)
- 10" stroke cylinder: 23" - 33" (Order ex. 973-10)
- Procedure arm (Order ex. 973-PA)
- Soft wheel casters or glides (Please specify)



963 Exam Stool: Single Lever Release

Standard Features:

- Standard height adjustment: 17" to 22"
- Seat diameter: 16"
- Base diameter: 24"
- California 117 fire resistant foam
- 3/4" thick composite substrate with steel reinforcement plate
- Weight capacity: 300 lbs.
- COM requirements 1 yd

Options:

- Back rest (Order ex. IN963-B)
- 18" Polished chrome foot rest (Order ex. IN963-F)
- 7" Stroke cylinder: 19" - 26" (Order ex. IN963-7)
- 10" Stroke cylinder: 23" - 33" (Order ex. IN963-10)
- Procedure arm (Order ex. IN963-PA)
- Soft wheel casters or glides (Please specify)



Medical Seating

933 Exam Stool: Manual Spin-Lift

Standard Features:

- Polished aluminum base
- Standard height adjustment: 19" to 24"
- Seat diameter: 16"
- Base diameter: 24"
- California 117 fire resistant foam
- 3/4" thick composite substrate with steel reinforcement plate
- Weight capacity: 300 lbs
- COM requirements 1 yd

Options:

- Back rest (Order ex. IN933-B)
- 18" polished chrome foot rest (Order ex. IN933-F)
- Soft wheel casters or glides (Please specify)



925 Exam Stool: Bariatric Fixed Height

Standard Features:

- Fixed seat height: 19"
- Seat diameter: 16"
- Base diameter: 26"
- Weight capacity: 600 lbs
- COM requirement 1 yd

Options:

- 21" height (IN926)
- Soft wheel casters or glides (Please specify)



AI3

873 Lab Stool: D-Handle

Standard Features:

- Polished aluminum base
- Seat height adjustment: 23" to 33"
- Seat diameter: 15 3/4"
- Base diameter: 24"
- California 117 fire resistant
- 3/4" thick composite substrate with steel reinforcement plate
- Adjustable seat back
- Seat back dimensions: 15 3/4" x 9 1/2"
- 18" diameter foot rest
- Standard with casters
- Weight capacity: 300 lbs.
- COM requirement 1 yd

Options:

- 7" stroke cylinder 19" - 26" (Order ex. IN873-7)
- Soft wheel casters or glides (Please specify)



863 Lab Stool: Single Lever Hand Release

Standard Features:

- Polished aluminum base
- Standard height adjustment: 19" to 24"
- Seat diameter: 16"
- Base diameter: 24"
- Overall height with backrest: 33" to 38"
- Pneumatic height adjustment
- COM requirement 1 yd

Options:

- Back rest (Order ex. IN983-B)
- 7" stroke cylinder: 19" - 26" (Order ex. IN983-7)
- 10" stroke cylinder: 23" - 33" (Order ex. IN983-10)
- Soft wheel casters or glides (Please specify)



Medical Seating

833 Ergonomic Lab Chair: Seat & Back Tilt

Standard Features:

- Polished aluminum base
- Standard height: 23" to 33"
- Base diameter: 24"
- Seat dimension: 20"W x 18"D
- Overall height with backrest: 38" to 48"
- Foot ring diameter: 20"
- Back dimension: 18"W x 16"H
- Adjustable back rest height only
- Pneumatic height adjustment
- Weight capacity: 300 lbs.
- COM requirements 1 yd

Options:

- 7" stroke cylinder: 20" - 27" (Order ex. IN833-7)
- T arms (Order ex. IN833-T)
- Soft wheel casters or glides (Please specify)



813 Ergonomic Lab Chair: Adjustable Back

Standard Features:

- Polished aluminum base
- Standard height: 23" to 33"
- Base diameter: 24"
- Seat dimension: 20"W x 18"D
- Overall height with backrest: 38" to 48"
- Foot ring diameter: 20"
- Back dimension: 16"W x 16"H
- Lateral back rest adjustment
- Pneumatic height adjustment
- Weight capacity: 300 lbs.
- COM requirements 1 yd

Options:

- 7" stroke cylinder: 20" - 27" (Order ex. IN813-7)
- T arms (Order ex. IN813-T)
- Soft wheel casters or glides (Please specify)



Medical Seating

748 Surgical Stool: Hydraulic w/ Silver Column

Standard Features:

- Brushed aluminum base
- Standard height: 19.5" to 26.5"
- Base diameter: 24"
- Seat diameter: 16"
- Overall height with backrest: 35.5" to 42.5"
- 1/2" chrome plated steel foot control
- Hydraulic height adjustment
- Rotation lock
- COM requirements 1 yd
- Weight capacity: 300 lbs.

Options:

- Back rest (Order ex. 748-B)
- Crescent back (Order ex. 748-CB)
- Soft wheel casters or glides (Please specify)



744 Surgical Stool: Hydraulic w/ Black Column

Standard Features:

- Black aluminum base
- Standard height: 19.5" to 26.5"
- Base diameter: 24"
- Seat diameter: 16"
- Overall height with backrest: 35.5" to 42.5"
- 1/2" chrome plated steel foot control
- Hydraulic height adjustment
- Rotation lock
- COM requirements 1 yd
- Weight capacity: 300 lbs.

Options:

- Back rest (Order ex. IN744-B)
- Crescent back (Order ex. IN748-CB)
- Soft wheel casters or glides (Please specify)



Medical Seating

610 Phlebotomy Chair: Upholstered

Standard Features:

- Seat height: 22"
- Seat dimension: 18.5"W x 18.5"D
- Back dimension: 19.5"W x 17"H
- Overall height: 37.5"
- Overall width: 28.5"
- Armrest adjustment height: 27" - 36"
- Overall depth: 29"
- Weight capacity: 1200 lbs.
- COM requirements 2yd

Also Available:

Bariatric Phlebotomy Chair (Order Ex. IN620)

- Seat dimensions: 24.5"W x 18.5"D
- Back dimensions: 25.5"W x 17"H
- Overall height: 37.5"
- Overall width: 34"
- Weight capacity: 1200 lbs
- COM requirements 2.5 yd



605 Phlebotomy Chair: Right Hand Arm Rest

Standard Features:

- Seat height: 22"
- Seat dimension: 18"W x 18"D
- Back dimension: 18"W x 12.5"H
- Armrest height: 27"
- Overall height: 31.5"
- Overall width: 23"
- Overall depth: 28"
- COM requirements 1.5 yd
- Weight capacity: 300 lbs.



Medical Seating

240 Patient Chairs: Wall Savers

Standard Features:

- 14 gauge tubular steel
- Seat height: 18"
- Overall height: 32"
- Overall width: 24"
- Seat dimension: 20.5"W x 19.5" D
- Back dimension: 21"W x 15"H
- Arm height: 26"
- Wall saver leg design
- Black powder coated frame
- COM requirements 2 yds
- Weight capacity 1200 lbs.

Also Available:

- Wall saver without arms (Order ex. IN242)
- Bariatric wall saver w/ arms (Order ex. IN241)
- Bariatric wall saver without arms (Order ex. IN240)



200 Patient Chairs: Stacking Wall Savers

Standard Features:

- 14 gauge black powder coated tubular steel
- Seat height: 18"
- Overall height: 32"
- Overall width: 24"
- Seat dimension: 18"W x 18" D
- Back dimension: 18"W x 12.5"H
- Arm height: 26"
- Stackable design
- COM requirements 2 yds
- Weight capacity: 250 lbs.

Also Available:

- Stacking wall saver with straight arms (Order ex. IN201)
- Stacking wall saver without arms (Order ex. IN200)



Clinical Recliners

Standard Care Cliner



- Standard trendelenberg release on back with easy-access handle
- Wide elastic bands on back frame & seat provide enhanced comfort and support
- Non-porous, fold-down side tray contains small spills (standard on right & left sides)
- Recessed hand-grips in entering and exiting chair
- Total-lock and directional-lock casters for easy maneuverability
- Removable side panels for easy cleaning and maintenance
- Optional accessories: heat or heat and massage, IV pole (left rear only), leg extensions, side cushion

Extra Large Care Cliner



- Standard trendelenberg release on back with easy-access handle
- Wide elastic bands on back frame & seat provide enhanced comfort and support
- Non-porous, fold-down side tray contains small spills (standard on right & left sides)
- Recessed hand-grips in entering and exiting chair
- Total-lock and directional-lock casters for easy maneuverability
- Removable side panels for easy cleaning and maintenance
- Optional accessories: heat or heat and massage, IV pole (left rear only), leg extensions, side cushion

Clinical Recliners

Elite Care Cliner

- Built-in headrest w/ headrest cover
- Standard trendelenburg release on back with easy access handle
- Non-porous, fold-down side tray contains small spills and standard for right and left sides
- Wide elastic bands on back frame and seat for enhanced comfort and support
- Fully upholstered arm/side panel for convenient cleaning and maintenance
- 5" nylon total-locking and directional-lock casters provide ease of maneuverability
- Variety of color options available
- Optional accessories: heat/massage, armrest covers, side cushions, IV pole, and leg extensions

***Also available with dual swing-arm armrests**



WI6900

Nocturnal Elite Care Cliner

- Left side swing-arm for modified entry and ease of cleaning
- User-adjustable positioning
- Attendant controlled trendelenburg foot release (on left and right side)
- Standard large fold-down table on left, pivot table on right; both accessible by attendant and patient
- Rear push handle
- Allows patient to lay flat easily
- Hide-away foot rest
- Independent leg rest
- Slide out foot plate for comfortable transportation
- 3 total-lock casters and 1 directional nylon caster provide easy maneuverability
- Optional accessories: oxygen tank holder, heat or heat and massage, armrest covers, side cushions, and IV pole



WI6980

Clinical Recliners

Inverness 24-Hour Treatment Recliner

- Fastener-free headrest cover
- Infinite position backrest
- Easy-pull bilateral recline handles
- Footrest with “heel drop” comfort zone
- Push handle
- Bilateral Trendelenburg access
- Foot operated arm release
- Safety shield mechanism guards
- Independent leg rest
- 180° swing arm
- Durable, easy-to-clean, powder-coated frame
- Fixed front casters with accessible lock tabs
- Locking, retractable foot plate
- Over 60 designer colors available
- Options: accessory hook, comfort-height side tables, IV pole + holder, and heat & massage switch



Drop Arm Standard Care Cliner

- Standard head-rest cover
- Padded drop-down armrests
- Dual fold down side tables
- Easy side panel cleaning
- Standard trendelenburg release on back with easy access handle
- Non-porous, fold-down side tray contains small spills and standard for right and left sides
- Wide elastic bands on back frame and seat for enhanced comfort and support
- One-touch release for drop-arms
- Total-lock and directional-lock casters (available in nylon or steel)
- Variety of color options available
- Optional accessories: IV pole, leg extensions, and side cushion



***Also available without drop arms**

Clinical Recliners

Premier LifeCare Recliner

- Push-handle for easy maneuverability
- Comfortable, contoured urethane armrests
- Low-profile 3" locking casters
- 3 position lock-bar feature for safe, secure, and comfortable positioning
- Multiple side-table options
- Fully upholstered
- "No pinch" safety zone
- Variety of colors available
- Optional accessories: IV pole, oxygen tank holder, pivot-table, designer black wheels (lowers arm, seat and height by .75"), side table, torso support, contoured headrest, lateral support, and/or side cushion



Cozy Comfort Premier Recliner

- Push-handle on back for easy maneuverability
- Optional non-porous, fold-down side tray table(s) contain small spills
- Low-profile 3" total lock casters
- Urethane armrests
- Webbed elastic suspension seat
- Variety of colors available
- Optional accessories: heat or heat & massage, IV pole, oxygen tank holder, wood armrests, pivot-table, side table, torso support, contoured headrest, and/or side cushion



***Also available in XL size**

Clinical Recliners

Convalescent Recliner

- Padded push-handle for easy maneuverability
- Comfortable, padded armrests with guards
- Non-porous tray, stores on side of chair (WI5251 or WI525S only)
- 5" total lock casters (in rear) for better control
- 3 position lock allows for safe, comfortable positioning
- Recessed hand-grips
- Variety of colors available
- Webbed suspension seating
- Side storage pocket comes standard on left panel
- WI525S/WI526S "saddle" seat models provide extra care and helps prevent skin breakdown
- Optional accessories: IV pole, torso support, lateral support, side cushion & flip-up footrests



(shown w/ optional saddle seat)

***Available with drop arms and/or XL size**

Caremor Cliner

- Push handle and back adjustment handle on back for infinite positioning
- Adjustment handle can be installed on side of chair for patient use
- Comfortable, padded armrests with guards
- Recessed hand-grips assist in entering/exiting chair
- Removable side panels for easy maintenance
- Webbed elastic suspension back and seat
- Continuous seat and legrest cushion
- Variety of colors available
- 5" total lock casters (in front) for better control
- Optional accessories: IV pole, flip-up footrests, contoured headrest, torso support, and/or side cushion



AJ5

Clinical Recliners

LifeCare Recliner

- Padded push-handle for easy maneuverability
- Comfortable, padded armrests with guards
- Non-porous tray, stores on side of chair
- 5" total lock casters (in rear) for better control
- 3 position lock allows for safe, comfortable positioning
- Plastic side panels help create a "safe zone" for patient care without pinch points
- Variety of colors available
- Webbed suspension seating
- Side storage pocket comes standard on left panel
- WI585S/WI586S "saddle" seat models provide extra care and helps prevent skin breakdown
- Optional accessories: IV pole, torso support, lateral support, side cushion & flip-up footrests



***Available with drop arms and/or XL size**

Elite Comfort Recliner

- Push-handle for easy maneuverability
- Built-in headrest
- Wide elastic bands on back frame provide enhanced comfort and support
- Non-porous, fold-down side tray contains small spills and standard on right side
- Black 3" nylon locking casters provide ease of maneuverability
- Optional accessories: heat or heat & massage, armrest covers, side cushion, IV pole, leg extensions, and/or left side tray



AJ6

Clinical Recliners

Transfer Cliner

- Infinite position back uses gas spring
- Convenient height push handle on back
- Durable powder-coated steel frame
- Standard seat belt provides additional safety
- Left/right drop arms have infinite positioning, including seat level
- Lays completely flat for easy transfers or to recline user in resting position
- Quick release tab for lowering and raising foot and leg rest
- 5" vinyl total-lock and directional-lock casters
- Independent leg rest
- Adjustable, fold-up foot rest
- Variety of colors available
- Optional IV pole available



Stretchair

- Adjustable padded arm rests lay flush for transfer in lay-flat position, raised as patient side guards, or removed altogether
- Fully upholstered in a wide variety of colors and styles
- Standard patient accessible lap/safety belt
- Integrated oxygen cylinder holder and IV pole with dual position mounts included
- 4 button handheld controller
- Flip-up and adjustable length footrests
- Independent leg rest operation
- Large rear-mounted storage bin
- Onboard battery charger, quick connect battery and charge indicator
- 1000 lb. weight capacity
- Centrally controlled multi-surface 6" casters with 4 wheel lock and 2 wheel steering settings



*This Page
Intentionally
Left Blank*

ECG/EKG Machines



NIECG-1350A

Recording Example: 12 Lead ECG 6 Traces, analysis results (auto gain)



Nihon Kohden Cardiofax Interpretive 12-Lead ECG Recorder

The Nihon Kohden Cardiofax M 1350A Color ECG/EKG machine is specifically designed to be a compact and easy to use for all medical setting. With its large color screen display, this ECG machine is perfect for viewing all 12-leads at the same time. The large memory capacity allows users to hold onto 40 ECG files in the internal memory, and 3000 ECG files with an SD memory card slot.

ECG/EKG Accessories Available!

Features and Options Overview:

- 12-leads at one time
- Selectable ID for record documentation
- Large color screen display
- Internal memory capacity of 40 ECG files
- SD memory card capacity of 3000 ECG files
- Compact design
- Variety of page formats for 12 leads/rhythms
- Light, flexible leadwire adapters
- Accommodates many electrode styles
- Patient cable protects units against high voltage shock
- Initiates recording in 4 seconds
- AC or rechargeable battery operation

*Four Year Warranty

*This Page
Intentionally
Left Blank*

Overbed Tables

Epoxy-Painted Base Overbed Table

- Tabletop dimensions: 32”L x 15.5”W
- Height adjustment: 29” - 46.5”
- Weight capacity: 40 lbs.
- Easily repositions at the touch of a button
- Constructed of reinforced cast aluminum
- Thick bull nosed edging protects walls/surface
- Available in 7 finishes (standard is solar oak)
- U-shaped base
- Dual 2” casters
- 1 year warranty



Available Finishes:



Kensington Maple

*
+



Monticello Maple



Solar Oak

*
+



Amber Cherry



Biltmore Cherry

+



African Walnut

*
+



Montana Walnut

***Camden finishes**

+ Hamilton finishes

*This Page
Intentionally
Left Blank*

Exam Tables/Chairs

Manual Exam Tables:

5240 Series Exam Table

- Seamless upholstery with antimicrobial guard
- Easy-reach articulating back adjustment
- One touch, easy-glide comfort stirrups with 3 lateral positions and fracture lock length adjustment
- Slide-out leg section with removable leg rest
- Removable 9" x 9" plastic drip pan
- Pull-out all steel non slip front step 7" high
- Paper roll holder (21")
- 2 front and 2 reversible storage drawers on full extension roller bearing drawing glides
- Leveling glides
- 500 lb. weight capacity
- Galvanized steel base, 18 gauge, powder coated



5250 Series Exam Table

- Seamless upholstery with antimicrobial guard
- Easy-reach articulating back adjustment
- One touch, easy-glide comfort stirrups with 3 lateral positions and fracture lock length adjustment
- Slide-out leg section with removable leg rest
- Removable 9" x 9" plastic drip pan
- Pull-out all steel non slip front step 7" high
- Paper roll holder (21")
- 2 front and 3 reversible storage drawers on full extension roller bearing drawing glides
- Leveling glides
- 500 lb. weight capacity
- Galvanized steel base, 18 gauge, powder coated



Exam Tables/Chairs

Manual Exam Tables:

420 Series Exam Table

- 5 full-size storage drawers
- 5 position continuous-lock stirrups
- Rubber grip pull-out step
- Paper roll holder
- Standard w/ pelvic tilt
- Pull-out leg rest w/ integrated treatment tray
- Height: 32"
- Foot step: 18"W x 17"L
- 800 lb. weight capacity
- Overall length: 72" (w/ leg rest extended)
- Width: 27"
- Drawer size: 18"W x 16.5"L x 4"D
- Weight capacity: 500 lbs.



400 Series Treatment Table

- Reinforced steel construction
- Includes roll paper holder
- Dimensions: 74"L x 27"W x 32"H
- 400 lb. weight capacity
- Paper widths: 18", 19" & 20"
- Assembly required
- Options: flat top, contour top, adjustable back, shelf, and/or 1 or 2 drawers



Exam Tables/Chairs

Manual Exam Tables:

5585 Series Treatment Table

- Seamless upholstery with antimicrobial guard
- Variety of colors available
- 350 lb. weight capacity
- 2 all metal storage drawers
- Heavy duty, full extension roller bearing drawer glides
- Leveling glides
- Optional accessories: paper cutter band, paper roll holder, fire retardant foam



5588 Series Treatment Table

- Seamless upholstery with antimicrobial guard
- Variety of colors available
- 350 lb. weight capacity
- Heavy duty, full extension roller bearing drawer glides
- Leveling glides
- Optional accessories: paper cutter band, paper roll holder, fire retardant foam



Exam Tables/Chairs

Manual Exam Tables:

8500 Series Treatment Table

- Durable medium density foam construction
- Sturdy steel leg frames
- Standard paper holder
- Adjustable leveling feet
- Heavy gauge expanded vinyl
- High strength powder-coated steel frame
- High impact leveling feet
- Optional fully laminated cabinet and/or drawer
- Optional accessories: shelves, cabinets, drawers, special leg heights (25" or 36"), & matching pillow
- Multiple colors available



8570 Series Adjustable Treatment Table

- Adjustable gas spring backrest with an angle range of 6 - 57°
- One-touch handle easily raises backrest to desired angle
- Standard paper holder
- High strength powder-coated steel frame
- High impact leveling feet ensure a sturdy table on almost any hard surface
- Heavy gauge expanded vinyl
- Medium density foam construction
- Optional accessories: shelves, cabinets, drawers, special leg heights (25" or 36"), & matching pillow
- Multiple colors available



Exam Tables/Chairs

Power Exam Tables:

4040 Power Exam Table

- Seamless upholstery with antimicrobial guard
- ADA compliant 19" low access seat height
- 600 lb. patient weight capacity
- Power hi-lo, backrest and pelvic tilt
- 2 function foot control
- Painted steel leg pullout and removable upholstered leg cushion
- Leg section elevates 10° for patient comfort
- Front storage drawer and removable stainless steel drain pan (3.5qt./3.3 L) and one touch, easy-glide stirrups
- Concealed paper roll holder (18"-21")
- Electromechanical actuator system
- Available in a variety of colors



4070 Power Exam Table

- Seamless upholstery with antimicrobial guard
- ADA compliant 19" low access seat height
- 600 lb. patient weight capacity
- Power hi-lo, and manual back with gas spring assist
- 1 function foot control
- Painted steel leg pullout and removable upholstered leg cushion
- Leg section elevates 10° for patient comfort
- Front storage drawer and removable stainless steel drain pan (3.5qt./3.3 L) and one touch, easy-glide stirrups
- Concealed paper roll holder (18"-21")
- Electromechanical actuator system
- Available in a variety of colors



Exam Tables/Chairs

Power Exam Tables:

460 Series Power Exam Table

- Pullout leg rest with integrated treatment tray
- Dual pedestal with DC electromagnetic driven power-lift
- 600 lb. patient weight capacity
- Electric-actuated drive backrest
- 5 position continuous-lock stirrups
- Powder coat foghorn finish
- Standard paper roll holder, cutter and pelvic tilt
- Optional foot control for height & back adjustment, and/or California TB-133



470 Series Bariatric Power Exam Table

- Quad pedestal base with DC electromagnetic drive
- 1000 lb. weight capacity (evenly distributed)
- Height: 20.5-37.5"
- Powder coat foghorn finish
- Paper roll holder widths: 18", 19", 20"
- California TB-133 option available
- Upholstered top dimensions: 76"L x 33"W



Exam Tables/Chairs

Economical Power Exam Tables:

5060 Economy Power Exam Table

- Seamless upholstery with antimicrobial guard
- 24" low access seat height
- 400 lb. weight capacity
- Power hi-lo, backrest, seat tilt, and leg section
- 2 function hand control
- Removable stainless steel drain pan (3.5qt./3.3L)
- Painted steel leg pullout
- Removable upholstered leg cushion
- Leg section elevates 10° for patient comfort
- One touch, easy-glide stirrups
- Concealed paper roll holder (18-21")
- Electromechanical actuator system
- Available in a variety of colors



5080 Economy Power Exam Table

- Seamless upholstery with antimicrobial guard
- 24" low access seat height
- 400 lb. weight capacity
- Power hi-lo, backrest, seat tilt, and leg section
- 2 function foot control
- Removable stainless steel drain pan (3.5qt./3.3L)
- Painted steel leg pullout
- Removable upholstered leg cushion
- Leg section elevates 10° for patient comfort
- One touch, easy-glide stirrups
- Concealed paper roll holder (18-21")
- Electromechanical actuator system
- Available in a variety of colors



Exam Tables/Chairs

Bariatric Exam Tables:

5005 Bariatric Exam Table

- Seamless upholstery with antimicrobial guard
- All-steel heavy duty construction
- 2 function hand control
- Concealed paper roll holder (18-21")
- Large, full extension storage drawers on roller bearing drawer guides
- Fully articulating 10" leg section
- Reinforced pull-out footstep with non-slip pad
- Electromechanical actuator system
- 800 lb. weight capacity
- Available in a variety of colors



(shown w/ optional accessory rail)

5050 Bariatric Exam Table w/ Power Backrest

- Seamless upholstery with antimicrobial guard
- All-steel heavy duty construction
- 1 function hand control
- Concealed paper roll holder (18-21")
- 4 large, full extension storage drawers on roller bearing drawer guides
- Fully articulating 10" leg section
- Reinforced pull-out footstep with non-slip pad
- Electromechanical actuator system
- 800 lb. weight capacity
- Available in a variety of colors



Exam Tables/Chairs

Power Procedure Chairs:

4010 Power Procedure Chair

- Seamless upholstery with antimicrobial guard
- ADA compliant 19" low access seat height
- 600 lb. patient weight capacity
- Power hi-lo, back, seat tilt, and leg section
- 4 function hand control (hi-lo, back, leg rest, & seat tilt)
- Articulating headrest
- Stainless steel leg pullout with removable drain pan (3.5 qt./3.3 L)
- Two position upholstered kneeler/footrest and one touch, easy-glide stirrups
- Concealed paper roll holder
- Trendelenburg position and electromechanical actuator system
- Variety of colors available



(Shown w/ optional accessory rail)

4011 Power Procedure Chair

- Seamless upholstery with antimicrobial guard
- ADA compliant 19" low access seat height
- 600 lb. patient weight capacity
- Power hi-lo, back, seat tilt, and leg section
- 4 function programmable foot control (hi-lo, back, leg rest, & seat tilt)
- Articulating headrest
- Stainless steel leg pullout with removable drain pan (3.5 qt./3.3 L)
- Two position upholstered kneeler/footrest and one touch, easy-glide stirrups
- Concealed paper roll holder
- Trendelenburg position and electromechanical actuator system
- Variety of colors available



(Shown w/ optional accessory rail)

Exam Tables/Chairs

Power Procedure Chairs:

5015 Power Podiatry/Wound Care Chair

- Seamless upholstery with antimicrobial guard
- Power hi-lo, backrest, and seat tilt
- 3 function memory position foot control
- 24" low access seat height
- 375 lb, weight capacity
- Adjustable, sliding, removable stainless steel debris tray (5.6 qt./5.3 L)
- Adjustable leg section and clear vinyl foot section cover
- Electromechanical actuator system
- Available in a variety of colors



(Shown w/ optional equipment)

5016 Power Podiatry/Wound Care Chair

- Seamless upholstery with antimicrobial guard
- Power hi-lo, backrest, and seat tilt
- 3 function memory position foot control
- 19" low access seat height
- 375 lb, weight capacity
- Adjustable, sliding, removable stainless steel debris tray (5.6 qt./5.3 L)
- Adjustable leg section and clear vinyl foot section cover
- Electromechanical actuator system
- Available in a variety of colors



(Shown w/ optional equipment)

Exam Tables/Chairs

Power Procedure Chairs:

8677 Power Phlebotomy/ENT Chair

- Seamless upholstery with antimicrobial guard
- 24" low access height
- 375 lb. patient weight capacity
- 2 function hand control
- Self positioning armrests and leg section
- Reclines to 30° from horizontal
- Electromechanical actuator system
- Available in a variety of colors



8678 Power Phlebotomy/ENT Chair

- Seamless upholstery with antimicrobial guard
- 24" low access height
- 375 lb. patient weight capacity
- Power hi-lo and backrest
- ADA compliant, 19" low access height
- 2 function hand control
- Self positioning armrests and leg section
- Reclines to 30° from horizontal
- Electromechanical actuator system
- Available in a variety of colors



Exam Tables/Chairs

Economy ENT and Phlebotomy Chairs

8612 Economy ENT Chair

- Sturdy steel frame
- Seamless upholstery with antimicrobial guard
- Available in a variety of colors
- 360° rotation with swivel lock
- 10° elevation from supine position
- Manual foot pedal height adjustment
- Manually adjustable backrest
- Manually adjustable footrest
- Hinged arms
- 250 lb. patient weight capacity



8675 Economy Phlebotomy Chair

- Sturdy steel frame
- Seamless upholstery with antimicrobial guard
- Available in a variety of colors
- 360° rotation with swivel lock
- 10° elevation from supine position
- Manual foot pedal height adjustment
- Manually adjustable backrest
- Manually adjustable footrest
- Interlinked backrest and leg section for reclining patient to horizontal position
- Hinged arms
- 250 lb. patient weight capacity



Exam Tables/Chairs

■ Economy Procedure & Blood-Drawing Chairs:

5020 Economy Power Procedure Chair

- Seamless upholstery with antimicrobial guard
- 24" low access seat height
- 400 lb. patient weight capacity
- Power hi-lo, back, seat tilt, and leg section
- 4 function hand control
- Articulating headrest
- Stainless steel leg pullout with 2 position upholstered kneeler/footrest
- Removable stainless steel drain pan (1.9qt./1.8L) and one touch, easy-glide stirrups
- Concealed paper roll holder (18-21")
- Trendelenburg position and electromechanical actuator system
- Variety of colors available



(shown w/ optional accessory rail)

8690 Bariatric Blood-Drawing Chair

- Seamless upholstery with antimicrobial guard
- Accommodates bariatric patients and parent with child
- Padded, flip-up, height adjustable armboard
- Heavy duty, all-welded steel frame
- 750 lb. patient weight capacity
- Adjustable leg levelers



(shown w/ flip-up tray)

Exam Tables/Chairs

Blood-Drawing Chairs:

2570/2571 Series Blood-Drawing Chair

- Durable plastic resin seat endures a year of use
- Flip-up, contoured urethane armrest provides easy access and added safety for the user
- Adjustable height armrest
- High impact leveling feet for complete sturdiness
- Fully laminated cabinet and drawer w/ roller glides (2570 only)
- Powder-coated steel frame
- Optional accessories: pivot or dual pivot arms, and IV pole
- Multiple colors available



2572/2573 Series Blood-Drawing Chair

- Comfortably padded seat and backrest
- Flip-up, contoured urethane armrest provides easy access and added safety for the user
- Adjustable height armrest
- High impact leveling feet for complete sturdiness
- Fully laminated cabinet and drawer w/ roller glides (2570 only)
- Powder-coated steel frame
- Optional accessories: pivot or dual pivot arms, and IV pole
- Multiple colors available



Diagnostic Equipment

Stethoscopes

We offer stethoscopes for all types of medical specialties from pediatric to cardiologist, to clinician, to ensure we fulfill all your diagnostic needs.



Otosopes/Ophthalmoscopes

Our line of otoscopes offer high quality optics and workmanship with consumer budget in mind.



Diagnostic Equipment

Sphygmomanometers

From clock aneroid sphygs to pocket sphygs we carry all types of sphygmomanometers to give customers the best possible options.



Blood Pressure Cuffs

We have all the essential blood pressure cuffs for your facility with sizes ranging all the way from newborn to adult.

Color Coded Cuff Sizes

NEWBORN	6cm to 11cm
INFANT	10cm to 19cm
CHILD	18cm to 26cm
ADULT	25cm to 35cm
LARGE ARM	33cm to 47cm
THIGH	46cm to 66cm



AN2

Scales

Mobile Digital Baby Scale

- Capacity: 44 lbs. / 20 kg.
- Graduation: 0.2 oz < 22 lbs. > 0.5 oz/5 g < 10 kg. > 10 g
- Only weighs 6.2 lbs. with carrying handle
- Large LCD figures
- Functions: TARE, BMIF, auto-HOLD, lbs/kg switch-over, automatic switch-off
- Battery operated
- Optional: measuring rod, head positioner, power adapter, switch-mode power adapter, carrying case



Digital Platform & Bariatric Scale

- Wireless transmission, RS232 compatible
- Capacity: 800 lbs. / 360 kg.
- Graduation: 0.1 lbs. / 50 g
- Functions: TARE, pre-TARE, HOLD, BMI, auto-HOLD, auto-CLEAR, lbs/kg switch-over, damping, automatic switch-off, SEND/PRINT
- Optional: stand for cable remote displays, power adapter, switch-mode power adapter



High Capacity Column Scale

- Wireless transmission, RS232 compatible
- Capacity: 660 lbs. / 300 kg./ 47 sts
- Graduation: 0.1 lbs. < 330 lbs. > 0.2 lbs. / 50 g < 150 kg. > 100 g / 0.1 lbs. < 23 sts > 0.2 lbs.
- Functions: TARE, pre-TARE, HOLD, BMI, mother/child-function, auto-HOLD, auto-CLEAR, lbs/kg switch over, damping, automatic switch-off, SEND/PRINT
- Measuring rod included
- Optional: telescopic measuring rod, power adapter, switch-mode, power adapter



Digital Measure & Weight Station

- Automatic BMI calculation
- Capacity: 550 lbs. / 250 kg.
- Graduation: 0.1 lbs. / 50 g
- Functions: TARE, HOLD, auto-BMI, lbs/kg switch-over
- Optional: RS232 interface
- Integrated measuring range: 43-79" (110-200 cm.)
- Graduation: 0.05" / 1 mm



Digital Column Scale

- BMI function
- Capacity: 450 lbs. / 200 kg
- Graduation: 0.2 lbs. / 100 g
- Functions: TARE, HOLD, BMI, lbs/kg switch-over, automatic switch-off
- Measuring rod included
- Optional: telescopic measuring rod, power adapter, switch-mode power adapter



Mechanical Column Scale

- Eye-level beam
- Capacity: 500 lbs. / 220 kg or 400 lbs. / 160 kg
- Graduation: 1/8 lb. / 50 g
- Functions: reset-to-zero function
- Measuring rod included



Surgical Instruments

Surgical Scissors

We carry a full line of high quality surgical scissors for any type of procedure you may need.



Thumb Forceps

We have all the thumb forceps you may need for use in any medical facility.



Forceps & Clamps

There are a variety of forceps and clamps needed in a surgical setting. We can provide all the forceps and clamps necessary at your facility.



Surgical Instruments

Retractors & Hooks

Retractors and hooks are available for your surgical instrument needs.



Needle Holders

We can supply with you all types of sizes and shapes for your needle holder needs.

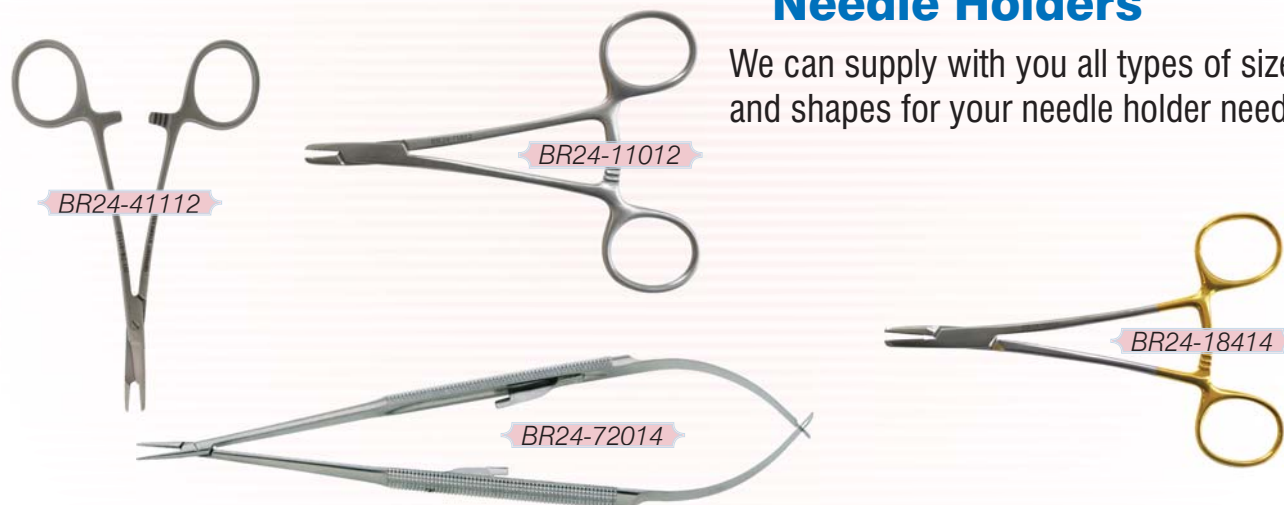

General Instruments

Along with many other surgical instruments, FHC carries products such as: blades, hammers, pin-wheels, and even cast spreaders for your convenience.

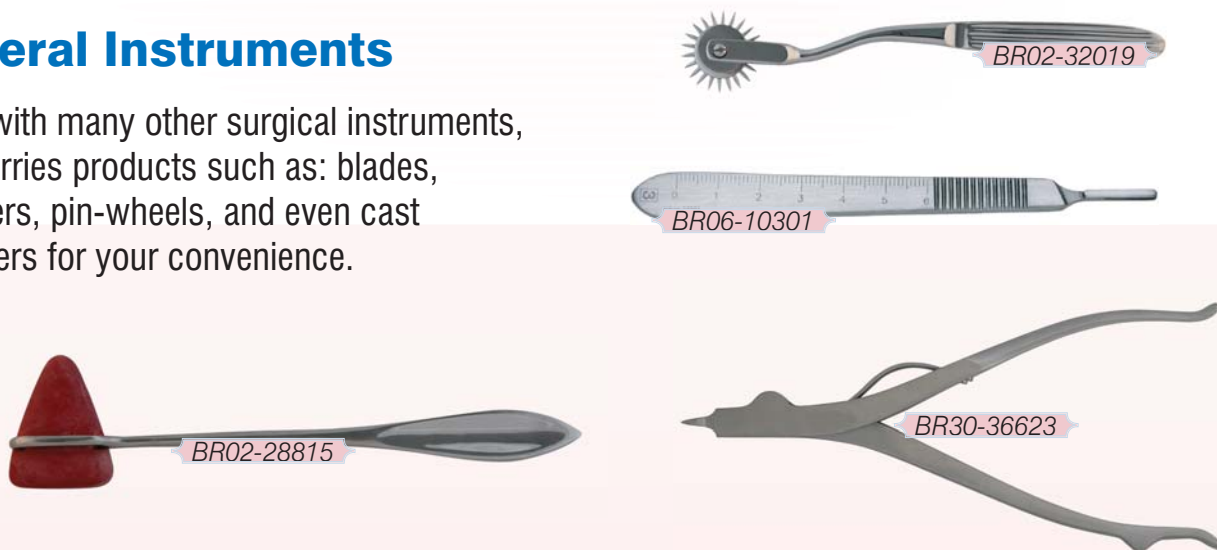

Wheelchairs

Traveler SE Series Wheelchair

- Black vinyl upholstery
- Chart pocket on back
- “Tool Free” adjustable front rigging
- Hammer tone paint provides durable finish
- Industry compatible front rigging
- 2-position axle and caster fork for 2” seat height and adjustment
- Maximum weight capacity of 250 lbs. (Evenly distributed)
- Meets Medicare code K0001 and K0002
- Limited 1 year warranty on side frames and cross braces



Traveler HD Series Wheelchair

- Embossed black leatherette upholstery with double inner lining for durability
- Hammer tone paint provides a durable finish
- Reinforced frame at all critical load-bearing points
- “Tool Free” adjustable front rigging
- Chart pocket standard on back upholstery
- 24” x 1” black plastic wheels with black handrims and non-marking polyurethane tires
- Front rigging with heel loops standard on swing-away footrests
- Durable aluminum black footplates
- 2-position axle and caster fork for 2” seat height and adjustment
- Maximum weight capacity of 500 lbs. (Evenly distributed)
- Meets Medicare code K0007
- 5 year warranty on side frames and cross braces



Wheelchairs

Paramount XD Series Wheelchair

- Best suited for bariatric patients
- Black reinforced nylon upholstery
- 19 1/2" seat depth
- Swing-away footrest and elevating legrest options
- Maximum weight capacity of 650 lbs. (Evenly distributed)
- Reinforced welds and gussets on frame
- 8" x 2" solid casters
- 24" solid rear wheels
- Limited lifetime warranty on frames and cross braces



Biodex MRI Wheelchair

- Non-ferrous with 3 available widths (18", 22", 26")
- Patient weight capacity of (250 lbs, 350 lbs., 550 lbs.)
- Roller bumpers for maximum comfort and protection
- Easy maneuverability with two 24" rear wheels with plastic wheel bearings
- Precision mounted 8" front casters are virtually unbreakable
- Chair locks securely for stable positioning
- Full-length armrests are removable for safe patient transfer
- Appearance helps eliminate confusion with non-MRI wheelchairs
- Burgundy upholstery is sealed and easily maintained
- Quick releaser safety belt and stainless steel IV pole are standard



Radiation Accessories

Lead Apron Options:

Any of our lead aprons can be custom fitted for a either for male or female by supplying the following information:

Front Aprons:

- Length (measure from the top of the shoulder, by the neck, straight down over the chest to the length required).
- Chest (measure around the chest at the underarm).

Two Piece Aprons:

- Chest (measure around the chest at the underarm).
- Vest Length (measure from the top of the shoulder over the chest to two inches below the waist).
- Waist.
- Hips (measure the widest part of the hips).
- Skirt Length (measure from the waist down to just above the knee).

Jacket

- Chest (measure around the chest at the underarm).
- Waist.
- Hips (measure around the widest part of the hips).
- Length (measure from the top of the shoulder down over the chest to the length desired).

SIZING CHART

TWO PIECE										
Size	MALE					FEMALE				
	Ht	Chest	Waist	Hips	Length (V/S)	Ht	Chest	Waist	Hips	Length (V/S)
S	5'5"	39"	28"	31"	22/20	5'2"	33"	28"	34"	19/20
M	5'7"	43"	34"	38"	24/20	5'5"	36"	31"	38"	20/23
L	5'11"	45"	39"	44"	25/21	5'8"	43"	34"	41"	22/23
Xl	6'2"	50"	42"	46"	26/21	5'10"	46"	37"	44"	22/23

JACKET										
Size	MALE					FEMALE				
	Ht	Chest	Waist	Hips	Length	Ht	Chest	Waist	Hips	Length
S	5'5"	40"	30"	40"	36"	5'2"	36"		38"	34"
M	5'7"	43"	37"	43"	38"	5'5"	38"		42"	37"
L	5'10"	45"	42"	46"	40.5"	5'8"	42"		46"	40.5"
Xl	5'11"	50"	50"	52"	42.5"	5'10"	46"		50"	42.5"

FRONT APRONS									
Size	MALE				FEMALE				
	Ht	Chest	Length	Width	Ht	Chest	Length	Dress	Width
S	5'5"	38"	34"	22.5"	5'2"	34"	34"	6-8	21"
M	5'7"	40-43"	37"	23"	5'5"	36-39"	36"	8-10	22"
L	5'11"	44-46"	40.5"	24"	5'7"	40-44"	38.5"	12-14	24"
Xl	6'2"	50-54"	42.5"	26"	5'11"	46-50"	40.5"	16-18	26"

SIZING CHART FOR XXTRA LARGE AND LARGER SIZES
(must use skin over XX size)

Size	SKIRT				VEST		JACKET			FRONT	
	MALE		FEMALE		MALE	FEMALE	MALE	FEMALE		MALE	FEMALE
	Hips	Waist	Hips	Waist	Chest	Chest	Chest	Chest	Hips	Chest	Chest
X	46"	42"	44"	37"	50"	46"	50"	46"	50"	50-54"	46"
XX	50"	46"	48"	41"	54"	50"	54"	50"	54"	54-58"	52"
XXX	54"	50"	52"	44"	58"	54"	58"	54"	58"	58-61"	56"
XXXX	58"	54"	56"		62"	58"	62"	58"		61"+	60"+

Radiation Accessories

Lead Weight Options:

	Lead Distribution		Average Attenuation	Pb. Equiv. at 80 k Vp	Approximate Weight of Front Aprons
	Jacket & Two Piece	Front Aprons			
REGULAR LEAD	.5mm front and .25mm back	.5mm lead equivalent	98.5%	.5mm	9lbs
FEATHERWEIGHT			98.5%	.5mm	8lbs
ULTRA-LITE			98.5%	.5mm	7lbs
EARTH-LITE			98.5%	.5mm	6lbs

REGULAR LEAD:

Our most economical lead which has been reformulated to make it more flexible and to reduce the weight without sacrificing the protection.

FEATHERWEIGHT:

Our Featherweight lead is approximately 15% lighter and more flexible than our regular lead but provides the same protection up to 100kVp.

ULTRA-LITE:

Unless you prefer to sacrifice protection, this is the lightest lead you can buy and still meet the standards of protection. Our Ultra-Lite aprons are approximately 10% lighter than our Featherweight aprons.

EARTH-LITE:

Protection without lead so it is environmentally safe. The Earth-Lite apron is the lightest apron available and meets the standards of protection.

WARRANTY

The manufacturer warrants all LEAD PRODUCTS to be free of defects in workmanship and materials for a period of one year. Seller's obligation is hereby limited exclusively to repair and replacement of any defective products. Seller hereby DISCLAIMS all other warranties, either expressed or implied including any implied warranty of MERCHANTABILITY. There are no warranties which extend beyond the description on the face herein.

DISPOSAL

Any apron manufactured by Pulse Medical will be disposed of by Pulse Medical at no charge for our valuable customers. To dispose any other lead, please contact the original manufacturer.

Radiation Accessories

Full Protection Aprons:



THE TWO PIECE APRON

When full protection becomes important, the **TWO PIECE** should be your choice. Two pieces add to your comfort through more efficient distribution of weight. Each front vest panel is .5mm Pb. equiv. The vest comes with shoulder pads, pocket, and embroidery. The skirt has hanging loops as well as attached belt to tighten the waist. For a smaller waist, we can sew elastic in the back of the skirt.

Part #		Part #
(Male)		(Female)
SMTF	Small	SFTP
MMTF	Medium	MFTP
LMTF	Large	LFTP
XMTF	X-Large	XFTP



THE SLOT STRETCHY BACK APRON

While still getting full protection, the customer also receives our lightest vest. This design incorporates back lumbar support with elastic in the back. The **SLOT STRETCHY BACK**, allows the customer to adjust for maximum comfort. We include shoulder pads, pocket, and embroidery.

Part #
SSBTP
(Specify Size and Gender)

To Order:

Type	Weight	Part #
Regular	9 lbs.	PU-
Featherweight	8 lbs.	PUFW-
Ultra-Lite	7 lbs.	PUUL-
Earth-Lite	6 lbs.	PUEL-

Ex: PUFW-LMTF = Large Male Featherweight Two-Piece Apron

Radiation Accessories

Full Protection Aprons:



THE JACKET APRON

Our **JACKET** apron was designed for optimal protection. Your comfort is also a primary concern so a wide support belt and shoulder pads are standard. Each front panel is .5mm Pb. equiv. An embroidered pocket is also included.

Part # (Male)		Part # (Female)
SMJ	Small	SFJ
MMJ	Medium	MFJ
LMJ	Large	LFJ
XMJ	X-Large	XFJ



THE BACK CLOSE WRAP JACKET

The **BACK CLOSE WRAP** is our lightest full protection jacket. As an improvement, this style has a strap across the shoulders to hold them in place. For a more secure fit, we added front buckles. Shoulder pads and an embroidered pocket are also included.

Part #
BCW
(Specify Size and Gender)

To Order:

Type	Weight	Part #
Regular	9 lbs.	PU-
Featherweight	8 lbs.	PUFW-
Ultra-Lite	7 lbs.	PUUL-
Earth-Lite	6 lbs.	PUEL-

Ex: PU-SFJ = Small Female Regular Jacket Aprons

Radiation Accessories

Full Protection Aprons:



THE MATERNITY JACKET APRON

The front of the **MATERNITY JACKET** apron (.5mm Pb equiv.) is tapered for maximum adjustability as needed. We can include a specially designed half-apron to be worn under the full apron for double protection in the abdomen-pelvic cavity (1.0mm Pb total equivalence). The lead used is the lightest currently available. Also available in front protection only.

Part #

MJMA (Medium: max waist 56")

LJMA (Large: max waist 60")



THE PONCHO APRON

The **PONCHO APRON** is an economical solution to the need for wrap-around protection. The one-sided Velcro closure allows greater flexibility in sizing. Front protection is .5mm Pb and the back is .25mm Pb equivalence. Sizing is unisex.

Part #

SPA (Small)

MPA (Medium)

LPA (Large)

XPA (X-Large)

(MUST SPECIFY GENDER)

To Order:

Type	Weight	Part #
Regular	9 lbs.	PU-
Featherweight	8 lbs.	PUFW-
Ultra-Lite	7 lbs.	PUUL-
Earth-Lite	6 lbs.	PUEL-

Ex: PUUL-LMA = Large Ultra-Lite Maternity Jacket

Radiation Accessories

Front Protection Aprons:

The reinforced straps are made to last and their unique positioning prevents the apron from falling off the shoulders. A belt loop is added to help hold the straps in place. Shoulder pads are standard as well as one embroidered pocket. A Velcro strap across the shoulders for added comfort is optional.

THE TIE APRON



FRONT

Part # (Male)		Part # (Female)
SMT	Small	SFT
MMT	Medium	MFT
LMT	Large	LFT
XMT	X-Large	XFT



BACK

Fluoro done? Get rid of your apron quickly and easily without breaking the sterile field. A shoulder drop-away can be used with our Stretchy Back and Cummerbund aprons. Shoulder pads are standard as well as one embroidered pocket.

THE DROP-AWAY APRON



FRONT

Part # (Male)		Part # (Female)
SMDA	Small	SFDA
MMDA	Medium	MFDA
LMDA	Large	LFDA
XMDA	X-Large	XFDA



BACK

To Order:

Type	Weight	Part #
Regular	9 lbs.	PU-
Featherweight	8 lbs.	PUFW-
Ultra-Lite	7 lbs.	PUUL-
Earth-Lite	6 lbs.	PUEL-

Ex: PUEL-MMT =
Medium Male Earth-Lite Tie Apron

AR6

Radiation Accessories

Front Protection Aprons:

Back discomfort is a complaint of the past when you wear our most comfortable apron. The wide belt takes the weight off the shoulders and provides lower back support. The shoulder pads are standard for additional comfort as well as one embroidered pocket. Shoulder drop-away optional.



FRONT

THE CUMMERBUND APRON

Part # (Male)		Part # (Female)
SMC	Small	SFC
MMC	Medium	MFC
LMC	Large	LFC
XMC	X-Large	XFC



BACK

Our unique Velcro design apron with elasticized back panels for additional support and comfort. Shoulder pads are a standard as well as one embroidered pocket. Shoulder drop-away optional. Also available with bucket closure.



FRONT

THE STRETCHY-BACK APRON

Part # (Male)		Part # (Female)
SMBS	Small	SFBS
MMBS	Medium	MFBS
LMBS	Large	LFBS
XMBS	X-Large	XFBS



BACK

To Order:

Type	Weight	Part #
Regular	9 lbs.	PU-
Featherweight	8 lbs.	PUFW-
Ultra-Lite	7 lbs.	PUUL-
Earth-Lite	6 lbs.	PUEL-

Ex: PUFW-SFC =
Small Female Cummberbund Apron

Radiation Accessories

Front Protection Aprons:

THE BUCKLE APRON



FRONT

The quick release buckle apron is user friendly and our large support straps crisscrossing the back allows proper placement of the belt at your waist. Built-in shoulder pads add to the comfort and are standard as well as one embroidered pocket.

Part #		Part #
(Male)		(Female)
SMB	Small	SFB
MMB	Medium	MFB
LMB	Large	LFB
XMB	X-Large	XFB

BACK



THE VELCRO APRON



FRONT

We have designed unique back straps to help position the apron while giving greater back support. Shoulder pads are included for additional comfort. Embroidered pocket is also included.

Part #		Part #
(Male)		(Female)
SMV	Small	SFV
MMV	Medium	MFV
LMV	Large	LFV
XMV	X-Large	XFV

BACK



To Order:

Type	Weight	Part #
Regular	9 lbs.	PU-
Featherweight	8 lbs.	PUFW-
Ultra-Lite	7 lbs.	PUUL-
Earth-Lite	6 lbs.	PUEL-

Ex: PU-XMV = Extra Large Male Regular Velcro Apron

Radiation Accessories

Front Protection Aprons:



FRONT

THE MATERNITY VELCRO APRON

This is a Velcro apron with a flared front for maximum adjustability as needed. We can include a specially designed half apron to be worn under the Velcro apron for double protection in the abdomen/pelvic cavity (1.00mm Pb equiv. total) The lead used is the lightest currently available. Also available in full protection.

See the Maternity Jacket Apron.

Size	Height	Chest	Length	Part#
Medium	5' 4"	36"	37"	MVMA
Large	5' 4"	40"	39"	LVMA
HA-8	Large Half Apron		30" x 18"	
HA-7	Medium Half Apron		26" x 16"	

To Order:

Type	Weight	Part #
Regular	9 lbs.	PU-
Featherweight	8 lbs.	PUFW-
Ultra-Lite	7 lbs.	PUUL-
Earth-Lite	6 lbs.	PUEL-

Ex: PUFW-LMTP = Large Male Featherweight Two-Piece Apron

FHC Apron Recovery:

We can recover any apron into practically any style and make it look like new. The customer assumes responsibility for checking the apron for holes prior to sending it to us. We will visually examine all lead and patch small up to 2 pin holes marked by the customer. Most aprons will be recovered with shoulder pads, and an embroidered pocket.

Recoveries are either:

- As is: same style, just replacing fabric and binding,
or
- Alteration required: tell us what to change (style or size) and we'll try to make it possible for you.

Apron Style	Part #
Buckle	PURB
Tie	PURT
Velcro	PURV
Cummerbund	PURC
Drop-Away	PURDA
Stretchy-Back	PURSB
Two Piece	PURTP
Jacket	PURJ
Slot Stretchy-Back Two Piece	PURSSBTP
Back Close Wrap	PURBCW

Radiation Accessories

Apron Accessories:

Demi-Apron Set/Rack

- Attached to soft steel spring for ease of application and to hold securely in place.
- Aprons may be purchased separately or as a set with or without the rack



Size	Width	Length	Part#
Small	8-1/2"	10"	PU803-S
Medium	12"	12"	PU803-M
Large	16"	14"	PU803-L
Xlarge	20"	16"	PU803-X

4 Demi Aprons with Rack	PU830
Demi Apron Rack Only	PU830-R

Apron Sleeves



- Attached with snaps and Velcro combination for security and comfort.
- Optional permanent attachment

Size	Length	Part#
Small	9" long	PUSS-100
Medium	11" long	PUSS-200
Large	13" long	PUSS-300
Pair	-	PUSS-500



Half Aprons

- Velcro closure
- Buckle upon request
- Custom sizes available



Drop-Away Shoulders

Convert your apron to a Drop-Away by closing the shoulders with Velcro rather than sewing.

Elastic in waist

Available for additional support or a small waist, we sew 6" wide elastic in the back panel of a skirt.



Scoliosis Shawl

Designed for use on spinal radiographic procedures involving upright or recumbent positions.

Radiation Accessories

Apron Accessories:

Thyroid Shields



Standard Thyroid

- The only thyroid made with 2" loop velcro and 1" hook, for easier closure.
- The softest, most comfortable thyroid collar made. No binding to irritate the neck.



Ring Attached

- Keep your collar attached to your apron, or detach it with this clever design.

Lap Pad

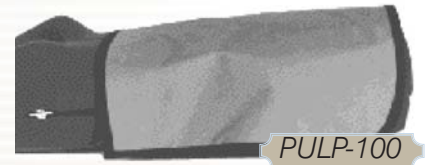

- Standard size: 18" x 24"
- Protection for any area of the body
- Any custom size available

Gonad Shields

Individual Shields (w/or w/o ties)



Gonad Shield Set

The set includes 2 small, 1 medium, 1 large gonad shields and a belt all with Velcro for an interchangeable system (shown with Gonad Shield & Belt System)

Size	Part#
Small (6 x 4")	PUGS-101
Medium (8 x 6")	PUGS-102
Large (10 x 7")	PUGS-103
Set of Four	PUGS-104

*Add T to part # for ties (PUGS-103T)



Cumberbund Belt

Size	Part#
to 25"	PU-ABXS
to 24-34"	PU-ABS
to 34-40"	PU-ABM
to 36-50"	PU-ABL
to 40-60"	PU-ABX

WOW Belt

- A patented pulley system cinches the belt for superior lumbar support.
- The perfect addition to keep the weight off the shoulders



Size	Part#
25-30"	PU-60122
30-35"	PU-60148
35-40"	PU-60137
40-45"	PU-60155
45-50"	PU-60170

Radiation Accessories

Apron Racks:



Hook Rack w/ 2 hooks

- One set of hooks
- Made of powder coated metal for durability and scratch resistance



Hook Rack w/ 4 hooks

- Four hooks with mounting plate
- Made of powder coated metal for durability and scratch resistance

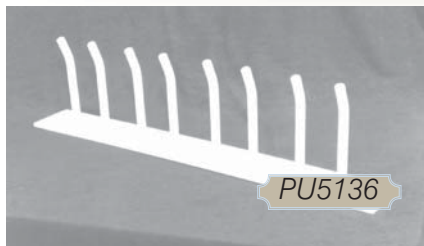

Eight Peg Rack

- Designed to hold four aprons
- Four mounting holds
- High tensile aluminum
- 24" long
- Other sizes available



Two Peg Rack

- Holds one apron, any style
- Two mounting holes
- High tensile aluminum



Single Apron Hanger

- Made specifically for lead aprons
- All metal construction

Deca Rack

- Designed with the busy OR in mind, the Deca Rack has 10 pivoted arms that fan out to 180°
- It is mounted on locking casters and has a finish of chromium and white.
- Also available with only 5 arms.



AR12

Apron & Glove Rack

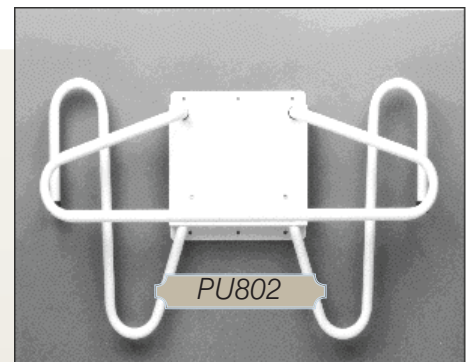

Radiation Accessories

Apron Accessories:



Valet Rack

- Dimensions: 54"H x 35"W x 24"D
- Hangers available at special price
- Almond coated metal
- Holds up to 12 aprons



Porta Rack

- Dimensions: 54"H x 35"W x 24"D
- Hangers available at special price
- Almond coated metal
- Holds up to 12 aprons



Mighty Mack

- Rugged mobile rack for ten aprons



Five Arm Swing Rack

- Space-saving hanger can fold to right or to left.
- Space required: 28"
- Order PU5137-R for right, PU5138-L for left

Radiation Accessories

Lead Glasses:

BASICS



Weight: 90 Grams
 Lead Equiv. Front: .75mmPb
 Lead Equiv. Side Shields : .75mmPb
 Prescriptions: Single, Bifocal, Progressive

A lightweight fashionable wrap around frame with a built in adjustable nose piece and spring hinges.

CLASSICS



80 grams
 .75mmPb front
 .35mmPb side
 All scripts
 Adjustable frame

FITOVERS/GOGGLES

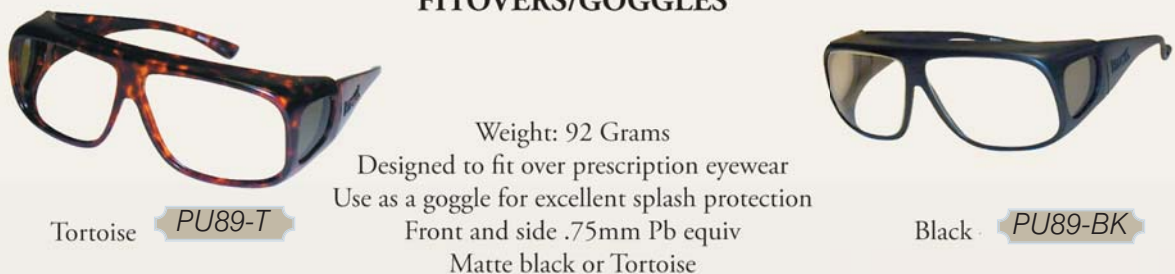

Weight: 92 Grams
 Designed to fit over prescription eyewear
 Use as a goggle for excellent splash protection
 Front and side .75mm Pb equiv
 Matte black or Tortoise

Radiation Accessories

Lead Glasses:

PULSE LITE



Bronze
PUPL-100S-BR



Satin Gray Blue
PUPL-100S-GB



Black
PUPL-100S-BL



Silver
PUPL-100S-S



Crimson
PUPL-100S-CR

Weight: 60 Grams
Lead Equiv. Front: .75mmPb
Lead Equiv. Side Shields: .35mmPb
(optional add "-S" after 100)
Prescriptions: Single, Bifocal

A lightweight fashionable wrap around frame with anti reflective coating. Available with lead sheeting as a side shield placed on the inside between the end of the lense and the ear piece.

PULSE LITE "MAXI"



Crimson Maxi
PUMAX-100-R

Weight: 63 grams
Lead Equiv. Front: .75mmPb
Lead Equiv. Side Shields: .35mmPb
(optional add "-S" after 100)



Silver Maxi

Shown with ultra soft fixed rubber nose piece

PUMAX-100-S



Black Maxi
PUMAX-100-BK

Prescriptions: Single, Bifocal, Progressive
Size: Slightly smaller than Pulse Lites
Other: Ultra soft fixed rubber nose piece



Silver Maxi

PUMAX-100-S



Blue Maxi

PUMAX-100-BL

ICICLE



Blue

PIC-100-B

Weight : 65 grams
Lead Equiv. Front: .75 mmPb
Lead Equiv. Side Shield: .35mmPb
(optional add "-S" after 100)
Prescriptions: Single, Bifocal



Orange

PIC-100-O

A beautiful Italian manufactured curved lense nylon frame. The optional lead sheeting side shields are placed on the inside between the end of the lense and the ear piece.

Radiation Accessories

Lead Glasses:



PUPD-100S-S

Silver

PREDATOR

- Front Lens: .75mmPb
- Side Shield: 50mm Pb
- No Script



Black

PUPD-100S-BK



PUNL-100S-BK

Black

NEON-LITES

- Front Lens: .75mmPb
- Side Shield: 50mm Pb
- Available w/o side shields
- No Script



Green

PUNL-100S-GR



PUNL-100S-OR

Orange



PUNL-100S-BL

Blue



PUNL-100S-PU

Purple

CRUISER FLEX

- .75mmPb front
- Plano only
- Optional side shields
- No scripts
- Black/yellow color only



PUCD-100

WVEX



PUPF-100-DT

The Pathfinder



PUDF-100-T

The Delta Force



PUSN-100-W

The Sniper

SPECIAL OPS

- .75mmPb front lens
- A donation will be made to the SEAL LEGACY FOUNDATION in support of fallen & wounded US NAVY SEALS & their Families
- Colors and specifications may vary



PUPA-100-SD

The Pararescue



PURE-100-R

The Recon



PUSE-100-R

The Seal



PURAN-100-BK

The Ranger



PUGB-100-W

The Green Beret

AR16

Radiation Accessories

Radiation Gloves:



PULG-12

Lead Gloves

- Flexible vinyl cover
- .5mm Pb protection
- 15" length



PURR1

Scatter-Reducing Gloves

- **PURR1** (+size) Attenuates 45% at 60kVp
- **PURR2** (+size) Attenuates 55% at 60kVp



Radiation Attenuating Surgical Gloves

- Reduced exposure to harmful rays
- Thin gloves of only .0009" thick for optimal flexibility, dexterity and sensitivity
- 100% tested for pin holes and leaks
- Gloves available in half sizes from 6.5 to 9
- Applicable with Fluoroscopy, Orthopedics, Radioisotope Handling, Cardiology, Radiology, Dental, and Nuclear Medicine

Performance:

Source Potential	R-1
60kVp	45%
80kVp	35%
100kVp	26%
120kVp	23%

Radiation Accessories

X-Ray Illuminators:

TL Series X-Ray Illuminators

- High quality & simple
- Two lamp light source per panel
- Flexi-Grip film-holding system
- Durable steel construction
- Thin 3" profile
- Chip resistant hospital white finish
- Continuous bottom film ledge
- 14" x 17" Viewing Area (per panel)
- Illumination: 2000 cd/m²
- Includes hospital grade plug
- Certified to UL 60601 standard (Non-UL versions available)
- Available in surface and recess configurations from 1-4 panels



Techline 200 Series X-Ray Illuminators

- Two F15IT8/D lamps (per panel)
- Instant-on ballasts
- Electronic
- Centralized cluster switching
- UL 60601 and cUL Certified
- Roller gravity film-holding system
- Thin 3" profile
- Durable steel construction
- Continuous bottom film ledge
- Chip resistant hospital white finish
- Even Vue reflective system
- Includes hospital grade plug
- Overall Dimensions 14"L x 21"H x 3 3/8"D
- Illumination: 2000 cd/m²
- Available in surface and recess configurations from 1 panel up to 6 over 6.
- Optional: film activated switching, master switch (standard on recessed units), mobile stand



Radiation Accessories

X-Ray Illuminators:

Techline 300 Series X-Ray Illuminators

- Three F15IT8/D lamps (per panel)
- Instant-on ballasts
- Electronic
- Centralized cluster switching
- UL 60601 and cUL Certified
- Roller gravity film-holding system
- Thin 3" profile
- Durable steel construction
- Continuous bottom film ledge
- Chip resistant hospital white finish
- Even Vue reflective system
- Includes hospital grade plug
- Overall Dimensions 14"L x 21"H x 3 3/8"D
- Illumination: 3000 cd/m²
- Available in surface and recess configurations from 1 panel up to 6 over 6.
- Optional: film activated switching, master switch (standard on recessed units), mobile stand



Techline 400 Series X-Ray Illuminators

- Four F15IT8/D lamps (per panel)
- Instant-on ballasts
- Electronic
- Centralized cluster switching
- UL 60601 and cUL Certified
- Roller gravity film-holding system
- Thin 3" profile
- Durable steel construction
- Continuous bottom film ledge
- Chip resistant hospital white finish
- Even Vue reflective system
- Includes hospital grade plug
- Overall Dimensions 14"L x 21"H x 3 3/8"D
- Illumination: 4000 cd/m²
- Available in surface and recess configurations from 1 panel up to 6 over 6.
- Optional: film activated switching, master switch (standard on recessed units), mobile stand



Radiation Accessories

X-Ray Illuminators:

Spine-Techline Specialty Illuminator

- 2 F30T12/D Lamps per tier
- Interior mechanical shutters
- Roller gravity film-holding system
- Handles 18 x 24cm & 24 x 30cm film
- Durable steel construction
- Chip resistant hospital white finish
- Continuous bottom film ledge
- UL 60601 and cUL listed
- Includes hospital grade plug
- Available in two-lamp and four-lamp configurations
- Overall Dimensions: 14"L x 42"H x 3 3/8"D
- Illumination: 24700 cd/m²
- Optional: film activated switching, master switch, and mobile stand



Techline 200 Series X-Ray Illuminators

- 2 F30T12/D Lamps per tier
- Interior mechanical shutters
- Roller gravity film-holding system
- Handles 18 x 24cm & 24 x 30cm film
- Durable steel construction
- Chip resistant hospital white finish
- Continuous bottom film ledge
- UL 60601 and cUL listed
- Includes hospital grade plug
- Available in two-lamp and four-lamp configurations
- 14" x 51" viewing area for full spine & long bone film formats
- Illumination: 24700 cd/m²
- Optional: film activated switching, master switch, and mobile stand



Radiation Accessories

X-Ray Illuminators & Carts:

Mammo-Techline Specialty Illuminator

- 3 F30T12/D Lamps per tier
- Interior mechanical shutters
- Roller gravity film-holding system
- Handles 18 x 24cm & 24 x 30cm film
- Durable steel construction
- Chip resistant hospital white finish
- Continuous bottom film ledge
- Meets ACR/MQSA recommendations
- UL 60601 and cUL listed
- Includes hospital grade plug
- Each viewing panel holds up to 4 films
- Available in single and double tier configurations
- Overall Dimensions: 36" L x 14" H x 5 1/4" D
- Illumination: 4000 cd/m²
- Optional mobile stand available



TechStand2 Mobile Illuminator Cart

- Adjustable height from 44" to 77" (from VESA mount to floor)
- Four heavy duty casters (two lockable)
- Adjustable 17 degree tilt to viewing area
- Maximum weight limit of 110 lbs.
- VESA mount = 20cm x 20cm
- Base size: 28.5"W x 29.25"L x 6"H (w/ casters)
- Shelf: 19.75"W x 15.75"L (3 height positions available)
- Cable routing: routes inside upright support pole
- Cart can support:
 - Configurations up to 2 over 2 standard 14" x 17" illuminator
 - Single & dual panel Spinal and Ortho illuminators
 - Single or dual tier Mammography illuminators
 - Single or dual panel MediPorts



Radiation Accessories

Flat Panel X-Ray Illuminators:

Vista X-Ray Film Illuminator



MAVT12AF(SH) /MAVT11AF(SH)

Lumivision X-Ray Film Illuminator



MALV12AF(SH) /MALV11AF(SH)

- Only 1-1/2" depth
- 20,000 hour lamp life
- Brightness: 3400 cd/m
- EEFL fluorescent lighting
- Flicker free
- UL, CE, CSA approved
- Includes medical grade plug
- Available in 1 - 4 panels wide
- Options: film activated switch, handle & stand, Vesa mount and hardwire

Lumivision same as Vista model except an optional dimming switch is available.

Medical Gas Systems

Expandable Vacuum Pump, 1.2 HP

- 3 phase 230/460 volt, 60Hz
- Vertical receiver
- Receiver drain tank
- Isolation valves
- Flexible connectors
- Inlet pressure gauges , check valves and filters
- Vibration isolators
- Automatic cascading controls which include: PLC with EERPRCM
- Motor starters with built in branch disconnects
- Pressure transducer
- H-O-A switches with hospital version meet NFPA 99 which includes bypass piping
- Dual transformers
- Alarms/dry alarm contacts conform with NFPA 99

* With discharge piping option



Duplex Tank Mount Vacuum System

- 3 phase 230/460 volt, 60Hz
- Horizontal receiver
- Isolation valves
- Flexible connectors
- Inlet pressure gauges, check valves, and filters
- Vibration isolators
- Automatic cascading controls which include: PLC with EERPRCM
- Motor starters with built in branch disconnects
- Pressure transducer
- H-O-A switches digital hour meters
- Run lamps bypass piping
- Dual transformers
- Alarms/dry alarm contacts conform with NFPA 99

* With discharge piping option



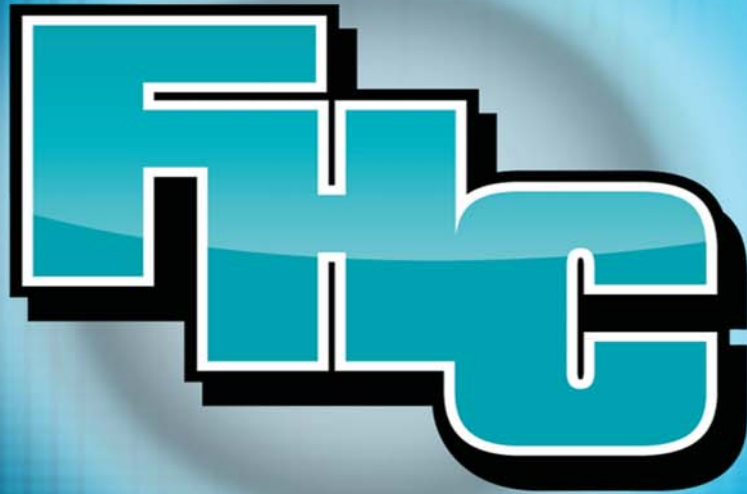

Future Health Concepts, Inc.

Visit our webpage: www.fhcusa.com

**1211 E. 30th Street
Sanford, FL 32773**

**Call Us: 800-282-8644
Fax Us: 407-322-3871
Email: sales@fhcusa.com**